





476
V. 15
Pt. 2
NH

DEPARTMENT OF THE INTERIOR

MONOGRAPHS

OF THE

UNITED STATES GEOLOGICAL SURVEY

VOLUME XV—PLATES



WASHINGTON
GOVERNMENT PRINTING OFFICE
1889



UNITED STATES GEOLOGICAL SURVEY

J. W. POWELL, DIRECTOR

THE POTOMAC

OR

YOUNGER MESOZOIC FLORA

BY

WILLIAM MORRIS FONTAINE



WASHINGTON
GOVERNMENT PRINTING OFFICE
1889



ILLUSTRATIONS.

- PLATE I.** Figs. 1-6, 8. *Equisetum Virginicum*.
 Fig. 7. *Equisetum Lyelli*.
II. Figs. 1-3, 6, 7, 9. *Equisetum Virginicum*.
 Figs. 4, 5. *Equisetum Lyelli*.
 Fig. 8. Rhizome of *Equisetum*, sp. undet.
 Fig. 10. *Equisetum Marylandicum*.
 Fig. 11. *Cladophlebis constricta*.
III. Fig. 1. *Cladophlebis latifolia*.
 Fig. 2. *Cladophlebis constricta*.
 Figs. 3-8. *Cladophlebis Virginiensis*.
IV. Figs. 1, 3-6. *Cladophlebis Virginiensis*.
 Fig. 2. *Cladophlebis denticulata*.
 Fig. 7. *Cladophlebis parva*.
 Fig. 8. *Cladophlebis falcata*.
V. Figs. 1-6. *Cladophlebis falcata*.
 Fig. 7. *Cladophlebis acuta*.
VI. Figs. 1-3. *Cladophlebis parva*.
 Fig. 4. *Cladophlebis latifolia*.
 Figs. 5, 6, 8-14. *Cladophlebis constricta*.
 Fig. 7. *Cladophlebis falcata*.
VII. Figs. 1, 2. *Cladophlebis falcata*.
 Figs. 3-5. *Cladophlebis oblongifolia*.
 Fig. 6. *Cladophlebis acuta*.
 Fig. 7. *Cladophlebis denticulata*.
 Figs. 8-11. *Angiopteridium auriculatum*.
VIII. Figs. 1-7. *Pecopteris Virginiensis*.
IX. Figs. 1-6. *Pecopteris Virginiensis*.
 Figs. 7-9. *Cladophlebis crenata*.
X. Figs. 1, 2. *Cladophlebis crenata*.
 Figs. 3, 4. *Cladophlebis inclinata*.
 Figs. 5, 8. *Cladophlebis*, sp. undet.
 Figs. 6, 7. *Cladophlebis acuta*.
 Fig. 9. *Asplenium dubium*.
XI. Figs. 1-6. *Aspidium Fredericksburgense*.
 Figs. 7, 8. *Cladophlebis acuta*.
XII. Figs. 1-6. *Aspidium Fredericksburgense*.
XIII. Figs. 1-3. *Cladophlebis crenata*.
 Figs. 4, 5. *Cladophlebis distans*.
 Figs. 6-8. *Pecopteris strictinervis*.
 Figs. 9, 10. *Aspidium ellipticum*.
XIV. Figs. 1-5. *Aspidium heterophyllum*.
XV. Figs. 1-5. *Aspidium heterophyllum*.
 Fig. 6. *Cladophlebis*, sp. undet.
 Fig. 7. *Aspidium Virginicum*.
 Fig. 8. *Pecopteris ovatodentata*.
XVI. Figs. 1, 3, 8. *Aspidium angustipinnatum*.
 Fig. 2. *Aspidium cystopteroides*.
 Figs. 4, 5. *Polypodium fadyenoides*.
 Fig. 6. *Aspleniopteris adiantifolia*.
 Fig. 7. *Acrostichum crassifolium*.
 Fig. 9. *Aspidium Fredericksburgense*.

- PLATE XVII.** Fig. 1. *Aspidium angustipinnatum*.
 Fig. 2. *Aspidium macrocarpum*.
 Figs. 3-7. *Thinnfeldia variabilis*.
XVIII. Figs. 1-6. *Thinnfeldia variabilis*.
XIX. Fig. 1. *Cladophlebis crenata*.
 Fig. 2. *Cladophlebis*, sp. undet.
 Fig. 3. *Cladophlebis*, sp. undet.
 Fig. 4. *Aspidium Oerstedii*?
 Fig. 5. *Cladophlebis alata*.
 Figs. 6, 7. *Aspidium Fredericksburgense*.
 Fig. 8. *Pecopteris microdonta*.
 Fig. 9. *Pecopteris strictinervis*.
 Fig. 10. *Aspidium angustipinnatum*.
XX. Figs. 1, 2, 4. *Pecopteris constricta*.
 Fig. 3. *Pecopteris strictinervis*.
 Figs. 5, 11. *Pecopteris microdonta*.
 Fig. 6. *Cladophlebis crenata*.
 Fig. 7. *Cladophlebis*, sp. undet.
 Fig. 8. *Cladophlebis inclinata*.
 Figs. 9, 10. *Cladophlebis rotundata*.
XXI. Figs. 1-3. *Pecopteris brevipennis*.
 Fig. 4. *Cladophlebis splenopteroides*.
 Fig. 5. *Aspidium oblongifolium*.
 Fig. 6. *Aspidium parvifolium*.
 Fig. 7. *Pecopteris socialis*.
 Fig. 8. *Stenopteris Virginia*.
 Figs. 9, 13. *Cladophlebis constricta*.
 Fig. 10. *Pecopteris angustipennis*.
 Fig. 11. *Gleichenia Nordenskioldi*.
 Fig. 12. Undetermined fern.
 Fig. 14. *Aspidium Virginicum*.
 Fig. 15. *Aspidium pinnatifidum*.
XXII. Figs. 1-3, 6, 7. *Aspleniopteris pinnatifida*.
 Figs. 4, 5. *Polypodium dentatum*.
 Fig. 8. *Cladophlebis petiolata*.
 Fig. 9. *Aspidium Dunkeri*.
 Figs. 10, 11. *Pecopteris Browniana*.
 Fig. 12. *Pecopteris ovatodentata*.
 Fig. 13. *Pecopteris strictinervis*.
XXIII. Fig. 1. *Pecopteris ovatodentata*.
 Figs. 2-7. *Pecopteris Browniana*.
XXIV. Fig. 1. *Thyrsopteris Virginia*.
 Fig. 2. *Pecopteris Virginiensis*.
 Fig. 3. *Thyrsopteris elliptica*.
 Figs. 4, 6, 7, 9. *Thyrsopteris dentata*.
 Figs. 5, 10. *Thyrsopteris brevifolia*.
 Fig. 8. *Aspidium parvifolium*.
XXV. Figs. 1, 2. *Thyrsopteris dentata*.
 Fig. 3. *Sphenopteris thyrsopteroides*.
 Figs. 4, 5, 16. *Thyrsopteris nervosa*.
 Figs. 6, 7, 14, 15. *Aspidium dentatum*.

- PLATE XXV. Fig. 8. *Cladophlebis inequiloba*.
 Fig. 9. *Cladophlebis pachyphylla*.
 Fig. 10. *Aspidium parvifolium*.
 Figs. 11, 12. *Aspidium Dunkeri*.
 Fig. 13. *Osmunda sphenopteroides*.
- XXVI. Figs. 1, 14, 16, 17. *Aspidium parvifolium*.
 Figs. 2, 8, 9, 18. *Aspidium Dunkeri*.
 Figs. 3, 13. *Pecopteris Browniana*.
 Figs. 4, 5. *Pecopteris pachyphylla*.
 Figs. 6, 7. *Thyrsopteris rarinerervis*.
 Figs. 10-12. *Thinnfeldia granulata*.
 Fig. 15. *Cladophlebis*, sp. undet.
- XXVII. Figs. 1-5, 8. *Thinnfeldia granulata*.
 Figs. 6, 7. *Thinnfeldia rotundiloba*.
 Fig. 10. *Sagenopteris latifolia*.
 Figs. 9, 11-17. *Sagenopteris elliptica*.
- XXVIII. Fig. 1. *Angiopteridium auticulatum*.
 Figs. 2, 4, 6. *Scleropteris elliptica*.
 Figs. 3, 5. *Scleropteris Virginica*.
 Fig. 7. *Scleropteris elliptica*, var. *longifolia*.
- XXIX. Fig. 1. *Scleropteris elliptica*.
 Fig. 2. *Angiopteridium nervosum*.
 Fig. 3. *Angiopteridium ellipticum*.
 Fig. 4. *Angiopteridium densinerve*.
 Fig. 5. *Angiopteridium pachyphyllum*.
 Figs. 6, 7. *Angiopteridium ovatum*.
 Figs. 8, 9. *Angiopteridium strictinerve*.
- XXX. Figs. 1, 5. *Angiopteridium strictinerve*, var. *latifolium*.
 Figs. 2, 3. *Anomozamites angustifolius*.
 Fig. 4. *Anomozamites Virginicus*.
 Figs. 6, 7. *Angiopteridium dentatum*.
 Fig. 8. *Platypterigium densinerve*.
- XXXI. Figs. 1, 4. *Platypterigium densinerve*.
 Fig. 2. *Platypterigium Rogersianum*.
 Fig. 3. *Anomozamites Virginicus*.
- XXXII. Figs. 1, 2. *Platypterigium densinerve*.
 XXXIII. Fig. 1. *Platypterigium densinerve*.
 Fig. 2. *Platypterigium Rogersianum*.
- XXXIV. Fig. 1. *Platypterigium densinerve*.
 Fig. 2. *Platypterigium Rogersianum*.
 Fig. 3. *Thyrsopteris brevipennis*.
 Fig. 4. *Sphenopteris acrocladata*.
- XXXV. Figs. 1, 2. *Platypterigium densinerve*.
 Figs. 3-5. *Sphenopteris latiloba*.
- XXXVI. Fig. 1. *Cladophlebis brevipennis*.
 Fig. 2. *Thyrsopteris brevipennis*.
 Fig. 3. *Thyrsopteris alata*.
 Figs. 4-9. *Sphenopteris latiloba*.
- XXXVII. Fig. 1. *Sphenopteris latiloba*.
 Figs. 2, 4. *Thyrsopteris nervosa*.
 Figs. 3, 9. *Thyrsopteris brevipennis*.
 Figs. 5-8. *Thyrsopteris divaricata*.
- XXXVIII. Fig. 1. *Thyrsopteris brevipennis*.
 Figs. 2-4, 8. *Thyrsopteris Meekiana*.
 Figs. 5-7, 9. *Thyrsopteris Meekiana*, var. *angustiloba*.
- XXXIX. Figs. 1, 2. *Thyrsopteris crenata*.
 Fig. 3. *Thyrsopteris densifolia*.
 Fig. 4. *Thyrsopteris insignis*.
 Fig. 5. *Thyrsopteris nervosa*.
- XL. Fig. 1. *Thyrsopteris insignis*.
 Figs. 2-5. *Thyrsopteris densifolia*.
 Fig. 6. *Thyrsopteris nervosa*.
- XLI. Figs. 1-3. *Thyrsopteris crassinervis*.
 Fig. 4. *Thyrsopteris brevipennis*.
 Fig. 5. *Osmunda Dicksonioides*.
- PLATE XLI. Fig. 6. *Thyrsopteris insignis*.
- XLII. Figs. 1, 2, 4. *Thyrsopteris insignis*.
 Fig. 3. *Thyrsopteris insignis*, var. *angustipennis*.
- XLIII. Figs. 1, 3. *Thyrsopteris insignis*.
 Fig. 2. *Thyrsopteris insignis*, var. *angustipennis*.
 Figs. 4-6. *Thyrsopteris rarinerervis*.
 Fig. 7. *Thyrsopteris decurrens*.
 Fig. 8. *Thyrsopteris Meekiana*, var. *angustiloba*.
- XLIV. Figs. 1, 2, 5. *Thyrsopteris rarinerervis*.
 Fig. 3. *Thyrsopteris Meekiana*, var. *angustiloba*.
 Fig. 4. *Thyrsopteris angustifolia*.
- XLV. Figs. 1, 2, 4, 5. *Thyrsopteris microphylla*.
 Fig. 3. *Thyrsopteris angustifolia*.
- XLVI. Fig. 1. *Thyrsopteris elliptica*.
 Figs. 2, 4. *Thyrsopteris decurrens*.
 Figs. 3, 5. *Thyrsopteris pachyrachis*.
- XLVII. Figs. 1, 2. *Thyrsopteris pachyrachis*.
 Fig. 3. *Thyrsopteris distans*.
 Fig. 4. *Thyrsopteris Meekiana*, var. *angustiloba*.
- XLVIII. Fig. 1. *Thyrsopteris Meekiana*, var. *angustiloba*.
 Fig. 2. *Thyrsopteris angustifolia*.
 Figs. 3-5. *Thyrsopteris angustiloba*.
- XLIX. Fig. 1. *Thyrsopteris pachyrachis*.
 Fig. 2. *Thyrsopteris rarinerervis*.
 Figs. 3, 4. *Thyrsopteris angustifolia*.
 Figs. 5-7. *Thyrsopteris decurrens*.
- L. Figs. 1, 2. *Sphenopteris Mantelli*.
 Fig. 3. *Thyrsopteris pachyphylla*.
 Fig. 4. *Sphenopteris spatulata*.
 Fig. 5. *Sphenopteris pachyphylla*.
 Figs. 6, 9. *Thyrsopteris elliptica*.
 Figs. 7, 8. *Thyrsopteris Meekiana*.
- LI. Fig. 1. *Thyrsopteris pecopteroides*.
 Fig. 2. *Thyrsopteris pinnatifida*.
 Fig. 3. *Thyrsopteris Meekiana*.
 Figs. 4, 6, 7. *Thyrsopteris elliptica*.
 Fig. 5. *Thyrsopteris densifolia*.
- LII. Fig. 1. *Thyrsopteris heteromorpha*.
 Figs. 2-4. *Thyrsopteris varians*.
 Fig. 5. *Thyrsopteris rhombifolia*.
- LIII. Figs. 1-3. *Thyrsopteris varians*.
 Fig. 4. *Thyrsopteris heteroloba*.
 Fig. 5. *Thyrsopteris bella*.
- LIV. Fig. 1. *Thyrsopteris rhombifolia*.
 Figs. 2, 11. *Thyrsopteris Meekiana*, var. *angustiloba*.
 Figs. 3, 9. *Aspidium Dunkeri*.
 Figs. 4, 5, 7. *Thyrsopteris pinnatifida*.
 Fig. 6. *Thyrsopteris elliptica*.
 Fig. 8. *Thyrsopteris distans*.
 Fig. 10. *Thyrsopteris varians*.
- LV. Fig. 1. *Thyrsopteris Meekiana*, var. *angustiloba*.
 Fig. 2. *Thyrsopteris angustifolia*.
 Fig. 3. *Thyrsopteris angustiloba*.
 Fig. 4. *Thyrsopteris elliptica*.
 Fig. 5. *Thyrsopteris microloba*, var. *alata*.
 Figs. 6, 7. *Thyrsopteris bella*.
- LVI. Figs. 1, 3. *Thyrsopteris Meekiana*, var. *angustiloba*.
 Figs. 2, 5. *Thyrsopteris bella*.

- PLATE LVI. Figs. 4, 8. *Thyrsopteris nana*.
Figs. 6, 7. *Thyrsopteris elliptica*.
- LVII. Figs. 1, 5. *Thyrsopteris bella*.
Fig. 2. *Thyrsopteris varians*.
Figs. 3, 8. *Thyrsopteris inaequipinnata*.
Fig. 4. *Thyrsopteris microloba*.
Fig. 6. *Thyrsopteris elliptica*.
Fig. 7. *Thyrsopteris pinnatifida*.
- LVIII. Fig. 1. *Thyrsopteris microloba*, var. *alata*.
Fig. 2. *Thyrsopteris elliptica*.
Fig. 3. *Thyrsopteris heterophylla*.
Fig. 4. *Thyrsopteris bella*.
Fig. 5. *Sphenopteris thyrsopteroides*.
Fig. 6. *Thyrsopteris sphenopteroides*.
Figs. 7, 10. *Thyrsopteris obtusiloba*.
Fig. 8. *Thyrsopteris angustifolia*.
Fig. 9. *Osmunda Dicksonioides*.
- LIX. Figs. 1, 4, 8, 9, 11. *Osmunda Dicksonioides*.
Figs. 2, 12. *Aspidium microcarpum*.
Fig. 3. *Thyrsopteris squarrosa*.
Fig. 5. Fern frond in circinate vernation.
Figs. 6, 7. *Thyrsopteris rhombiloba*.
Fig. 10. *Thyrsopteris retusa*.
- LX. Figs. 1, 3. *Osmunda Dicksonioides*, var. *latipennis*.
Figs. 2, 4, 5, 9. *Osmunda Dicksonioides*.
Figs. 6, 7. *Aspidium microcarpum*.
Fig. 8. *Thyrsopteris rhombiloba*.
- LXI. Figs. 1, 2. *Osmunda Dicksonioides*.
Fig. 3. *Osmunda Dicksonioides*, var. *latipennis*.
Figs. 4, 5. *Ctenopteris insignis*.
Fig. 6. Undetermined plant.
Fig. 7. *Zamiopsis pinnatifida*.
Fig. 8. *Zamiopsis longipennis*.
- LXII. Fig. 1. *Ctenopteris insignis*.
Fig. 2. *Ctenopteris integrifolia*.
Fig. 3. *Zamiopsis insignis*.
Fig. 4. *Ctenopteris Virginicensis*.
Fig. 5. *Zamiopsis pinnatifida*.
- LXIII. Figs. 1, 2. *Ctenopteris insignis*.
Figs. 3, 4. *Scleropteris dentata*.
- LXIV. Figs. 1, 3. *Zamiopsis insignis*.
Fig. 2. *Zamiopsis pinnatifida*.
- LXV. Fig. 1. *Ctenopteris Virginicensis*.
Fig. 2. *Ctenopteris angustifolia*.
Fig. 3. *Ctenopteris integrifolia*.
Figs. 4-6. *Zamiopsis insignis*.
- LXVI. Figs. 1, 5-8. *Zamiopsis laevis*.
Fig. 2. *Zamiopsis insignis*.
Fig. 3. *Zamiopsis petiolata*.
Fig. 4. *Ctenopteris Virginicensis*.
- LXVII. Fig. 1. *Zamites tenuinervis*.
Fig. 2. *Zamiopsis pinnatifida*.
Fig. 3. *Ctenopteris minor*.
Fig. 4. *Ctenopteris angustifolia*.
Fig. 5. *Ctenopteris longifolia*.
Fig. 6. *Dioonites Buchianus*, var. *angustifolius*.
Fig. 7. *Zamiopsis insignis*.
- LXVIII. Fig. 1. *Dioonites Buchianus*.
Figs. 2, 3. *Ctenophyllum latifolium*.
Fig. 4. *Dioonites Buchianus*, var. *angustifolius*.
Fig. 5. *Glossozamites distans*.
Fig. 6. *Podozamites subulcatus*.
- LXIX. Figs. 1, 3. *Dioonites Buchianus*.
Fig. 2. *Zamites tenuinervis*.
- LXX. Fig. 4. *Zamites crassinervis*.

- PLATE LXX. Fig. 1. *Zamites tenuinervis*.
Figs. 2, 3. *Dioonites Buchianus*.
Fig. 4. *Encephalartopsis nervosa*.
- LXXI. Fig. 1. *Dioonites Buchianus*.
Fig. 2. *Dioonites Buchianus*, var. *angustifolius*.
Figs. 3, 4. *Encephalartopsis nervosa*.
- LXXII. Figs. 1, 2. *Dioonites Buchianus*.
Figs. 3, 4. *Encephalartopsis nervosa*.
- LXXIII. Figs. 1-3. *Dioonites Buchianus*.
- LXXIV. Figs. 1-3. *Dioonites Buchianus*.
- LXXV. Fig. 1. *Nageiopsis longifolia*.
Fig. 2. *Nageiopsis recurvata*.
Fig. 3. *Zamites tenuinervis*.
- LXXVI. Fig. 1. *Podozamites pedicellatus*.
Figs. 2-6. *Nageiopsis longifolia*.
Fig. 7. *Zamites tenuinervis*.
- LXXVII. Figs. 1, 2. *Nageiopsis longifolia*.
Fig. 3. *Nageiopsis decrescens*.
Fig. 4. *Nageiopsis ovata*.
- LXXVIII. Figs. 1-5. *Nageiopsis longifolia*.
Fig. 6. *Zamites tenuinervis*.
Fig. 7. *Podozamites pedicellatus*.
- LXXIX. Figs. 1, 3. *Nageiopsis zamioides*.
Figs. 2, 6. *Nageiopsis crassicaulis*.
Fig. 4. *Nageiopsis recurvata*.
Fig. 5. *Podozamites distantinervis*.
Fig. 7. *Nageiopsis longifolia*.
- LXXX. Figs. 1, 2, 4. *Nageiopsis zamioides*.
Fig. 3. *Nageiopsis recurvata*.
Fig. 5. *Nageiopsis ovata*.
Fig. 6. *Podozamites acutifolius*.
- LXXXI. Figs. 1-6. *Nageiopsis zamioides*.
- LXXXII. Fig. 1. *Nageiopsis crassicaulis*.
Fig. 2. *Podozamites grandifolius*.
Fig. 3. *Nageiopsis latifolia*.
Fig. 4. *Podozamites distantinervis*.
Fig. 5. *Podozamites pedicellatus*.
- LXXXIII. Figs. 1, 2, 6, 7. *Podozamites distantinervis*.
Fig. 3. *Zamites crassinervis*.
Fig. 4. *Zamites distantinervis*.
Fig. 5. *Podozamites grandifolius*.
- LXXXIV. Figs. 1, 2, 8, 10, 14, 15. *Podozamites distantinervis*.
Figs. 3, 9, 11. *Nageiopsis crassicaulis*.
Fig. 4. *Nageiopsis heterophylla*.
Fig. 5. *Phyllocladopsis heterophylla*.
Fig. 6. *Nageiopsis microphylla*.
Fig. 7. *Zamites tenuinervis*.
Fig. 12. *Zamites* ? sp. undet.
Fig. 13. *Zamites subulcatus*.
- LXXXV. Figs. 1, 3, 8, 9. *Nageiopsis longifolia*.
Fig. 2. *Zamites subulcatus*.
Fig. 4. *Zamites ovalis*.
Fig. 5. *Feildeniopsis crassinervis*.
Fig. 6. *Nageiopsis inaequilateralis*.
Fig. 7. *Nageiopsis obtusifolia*.
Figs. 10, 15. *Podozamites acutifolius*.
Fig. 11. *Nageiopsis acuminata*.
Figs. 12, 16. *Podozamites distantinervis*.
Fig. 13. *Araucaria obtusifolia*.
Fig. 14. *Nageiopsis microphylla*.
- LXXXVI. Figs. 1-3, 5. *Nageiopsis microphylla*.
Fig. 4. *Araucaria podocarpoidea*.
Figs. 6, 7. *Nageiopsis heterophylla*.
Figs. 8, 9. *Nageiopsis angustifolia*.

- PLATE LXXXVII.** Fig. 1. *Podozamites acutifolia*.
Figs. 2-6. *Nagelopsis angustifolia*.
- LXXXVIII.** Figs. 1, 3, 4, 6-8. *Nagelopsis angustifolia*.
Figs. 2, 5. *Nagelopsis heterophylla*.
- LXXXIX.** Figs. 1, 3. *Baieropsis expansa*.
Fig. 2. *Nagelopsis angustifolia*.
Fig. 4. *Baieropsis pluripartita*.
- XC.** Fig. 1. *Baieropsis expansa*.
Figs. 2-5. *Baieropsis pluripartita*.
Fig. 6. *Baieropsis macrophylla*.
- XCI.** Figs. 1, 3, 4, 7. *Baieropsis pluripartita*.
Fig. 2. *Baieropsis expansa*.
Fig. 5. *Baieropsis pluripartita*, var. minor.
Fig. 6. *Baieropsis longifolia*.
- XCII.** Figs. 1, 2, 6. *Baieropsis pluripartita*.
Figs. 3, 4. *Baieropsis pluripartita*, var. minor.
Fig. 5. *Baieropsis expansa*.
Fig. 7. *Baieropsis denticulata*, var. angustifolia.
- XCIII.** Figs. 2, 9. *Baieropsis adiantifolia*.
Figs. 1-3. *Baieropsis adiantifolia*.
Figs. 4-6. *Baieropsis foliosa*.
Fig. 7. *Baieropsis denticulata*.
- XCIV.** Fig. 1. *Baieropsis adiantifolia*, var. minor.
Figs. 2, 3. *Baieropsis adiantifolia*.
Fig. 4. *Acrostichopteris densifolia*.
Figs. 5, 9, 10, 12. *Acrostichopteris parvifolia*.
Figs. 6, 7, 11, 14. *Acrostichopteris parvifolia*.
Fig. 8. *Acrostichopteris cyclopteroides*.
Fig. 13. *Baiera multifolia*.
- XCv.** Figs. 1-5. *Frenelopsis ramosissima*.
- XCVI.** Figs. 1-3. *Frenelopsis ramosissima*.
- XCvII.** Figs. 1-6. *Frenelopsis ramosissima*.
- XCvIII.** Figs. 1-6. *Frenelopsis ramosissima*.
- XCIX.** Figs. 1-4. *Frenelopsis ramosissima*.
C. Figs. 1-3. *Frenelopsis ramosissima*.
Fig. 4. *Brachyphyllum crassicaule*.
- CI.** Fig. 1. *Frenelopsis ramosissima*.
Figs. 2, 3. *Leptostrobus longifolius*.
Fig. 4. *Leptostrobus foliosus*.
- CII.** Figs. 1-4. *Leptostrobus longifolius*.
Figs. 5, 6. *Laricopsis brevifolia*.
Figs. 7, 8. *Laricopsis longifolia*.
Figs. 9, 10. *Laricopsis angustifolia*.
- CIII.** Figs. 1, 4. *Laricopsis angustifolia*.
Figs. 2, 3. *Laricopsis longifolia*.
Fig. 5. *Leptostrobus foliosus*.
Figs. 6-12. *Leptostrobus longifolius*.
- CIV.** Fig. 1. *Leptostrobus foliosus*.
Figs. 2, 3. *Cephalotaxopsis ramosus*.
Figs. 4, 5. *Cephalotaxopsis magnifolia*.
Fig. 6. *Leptostrobus longifolius*.
- CV.** Figs. 1, 2, 4. *Cephalotaxopsis magnifolia*.
Fig. 3. *Cephalotaxopsis brevifolia*.
- CVI.** Figs. 1, 3. *Cephalotaxopsis magnifolia*.
Figs. 2, 4. *Cephalotaxopsis ramosa*.
Fig. 5. *Cephalotaxopsis brevifolia*.
- CVII.** Figs. 1, 2, 4. *Cephalotaxopsis magnifolia*.
Fig. 3. *Cephalotaxopsis ramosa*.
Figs. 5. *Cephalotaxopsis brevifolia*.
- CVIII.** Figs. 1, 3, 4. *Cephalotaxopsis magnifolia*.
Fig. 2. *Cephalotaxopsis ramosa*.
- PLATE CVIII.** Fig. 5. *Cephalotaxopsis microphylla*.
- CIX.** Figs. 1-7. *Brachyphyllum crassicaule*.
Fig. 8. *Torreya Virginica*.
Fig. 9. *Cephalotaxopsis microphylla*.
- CX.** Figs. 1-3. *Brachyphyllum crassicaule*.
Fig. 4. *Brachyphyllum parceramosum*.
- CXI.** Figs. 1-5. *Frenelopsis parceramosa*.
Figs. 6, 7. *Brachyphyllum crassicaule*.
- CXII.** Figs. 1-5. *Frenelopsis parceramosa*.
Figs. 6-8. *Brachyphyllum crassicaule*.
Figs. 9-11. *Sequoia cycadopsis*.
- CXIII.** Figs. 1-3. *Sequoia cycadopsis*.
Fig. 4. *Torreya falcata*.
Figs. 5, 6. *Athrotaxopsis expansa*.
- CXIV.** Figs. 1-3. *Athrotaxopsis grandis*.
Figs. 4, 5. *Athrotaxopsis tenuicaulis*.
- CXV.** Figs. 1, 3. *Athrotaxopsis pachyphylla*.
Fig. 2. *Athrotaxopsis expansa*.
Fig. 4. *Athrotaxopsis tenuicaulis*.
- CXVI.** Figs. 1-4. *Athrotaxopsis grandis*.
Fig. 5. *Athrotaxopsis expansa*.
Fig. 6. *Athrotaxopsis tenuicaulis*.
Fig. 7. *Sequoia*, sp. undet.
- CXVII.** Figs. 1, 3-5. *Athrotaxopsis pachyphylla*.
Fig. 2. *Athrotaxopsis tenuicaulis*.
Fig. 6. *Athrotaxopsis expansa*.
Fig. 7. *Sequoia subulata*.
- CXVIII.** Figs. 1, 4. *Sequoia Reichenbachii*.
Fig. 2. *Sequoia ambigua*.
Fig. 3. *Sequoia rigida*.
Figs. 5, 6. *Sequoia subulata*.
Fig. 7. *Sphenolepidium Sternbergianum*, var. densifolium.
- CXIX.** Figs. 1-5. *Sequoia Reichenbachii*.
- CXX.** Figs. 1-6. *Sequoia ambigua*.
Figs. 7, 8. *Sequoia Reichenbachii*.
Fig. 9. *Sequoia*, sp. undet.
- CXXI.** Fig. 1. *Araucaria ramioides*.
Fig. 2. *Sequoia rigida*.
Fig. 3. *Sequoia denticulata*.
Fig. 4. *Sequoia densifolia*.
Figs. 5, 7, 9. *Sphenolepidium Sternbergianum*, var. densifolium.
Fig. 6. *Taxodium (Glyptostrobus) Virginicum*.
Figs. 8, 10, 11. *Sphenolepidium Sternbergianum*.
- CXXII.** Fig. 1. *Taxodium (Glyptostrobus) Brookense*.
Fig. 2. *Sequoia Reichenbachii*.
- CXXIII.** Fig. 1. *Taxodium (Glyptostrobus) expansum*.
Figs. 2, 3. *Taxodium (Glyptostrobus) ramosum*.
- CXXIV.** Fig. 1. *Taxodium (Glyptostrobus) denticulatum*.
Fig. 2. *Taxodium (Glyptostrobus) ramosum*.
Figs. 3-9. *Taxodium (Glyptostrobus) Brookense*.
- CXXV.** Figs. 1, 3. *Taxodium (Glyptostrobus) fastigiatum*.
Fig. 2. *Sphenolepidium Sternbergianum*, var. densifolium.
Fig. 4. *Sphenolepidium Virginicum*.
- CXXVI.** Figs. 1, 5, 6. *Sphenolepidium Kurrianum*.
Fig. 2. *Sequoia rigida*.
Figs. 3, 4. *Sequoia gracilis*.
- CXXVII.** Fig. 1. *Taxodium (Glyptostrobus) ramosum*.

- PLATE CXXXVII. Fig. 2. *Sphenolepidium recurvifolium*.
Figs. 3, 4. *Sphenolepidium dentifolium*.
Fig. 5. *Sequoia ambigua*.
- CXXXVIII. Figs. 1, 7. *Sphenolepidium Kurrianum*.
Figs. 2-6. *Sphenolepidium dentifolium*.
- CXXXIX. Figs. 1, 2, 4, 6, 8. *Sphenolepidium Kurrianum*.
Fig. 3. *Sphenolepidium Sternbergianum*, var. *densifolium*.
Fig. 5. *Sphenolepidium dentifolium*.
Fig. 7. *Sphenolepidium parceramosum*.
- CXXX. Fig. 1. *Sphenolepidium Sternbergianum*, var. *densifolium*.
Figs. 2, 7. *Sphenolepidium recurvifolium*.
Fig. 3. *Sequoia rigida*.
Figs. 4-6, 10. *Sphenolepidium dentifolium*.
Fig. 8. *Sphenolepidium parceramosum*.
Fig. 9. *Sphenolepidium Sternbergianum*.
Fig. 11. *Sphenolepidium Kurrianum*.
- CXXXI. Figs. 1, 3. *Sphenolepidium Sternbergianum*, var. *densifolium*.
Fig. 2. *Sphenolepidium parceramosum*.
Fig. 4. *Sphenolepidium Kurrianum*.
Fig. 5. *Taxodium* (*Glyptostrobus*) *Brookense*.
Figs. 6, 7. *Sphenolepidium pachyphyllum*.
- CXXXII. Fig. 1. *Taxodium* (*Glyptostrobus*) *ramosum*.
Figs. 2, 5, 6. *Sequoia*, sp. undet.
Fig. 3. *Sequoia ambigua*.
Fig. 4. *Sphenolepidium Sternbergianum*, var. *densifolium*.
Fig. 7. *Abietes macrocarpus*.
Figs. 8, 9. *Abietes ellipticus*.
Fig. 10. *Sequoia*, sp. undet.
- CXXXIII. Fig. 1. *Abietes angusticarpus*.
Figs. 2-4. *Abietes ellipticus*.
Figs. 5-7. *Williamsonia Virginienis*.
Figs. 8-12. *Araucarites Aqiensis*.
- CXXXIV. Fig. 1. *Carpolithus fasciculatus*.
Figs. 2-4, 6, 8. *Carpolithus ternatus*.
Fig. 5. *Carpolithus agglomeratus*.
Fig. 7. *Araucarites Virginicus*.
Fig. 9. *Carpolithus conjugatus*.
Fig. 10. *Carpolithus geminatus*.
Figs. 11-14. *Carpolithus Virginienis*.
- CXXXV. Figs. 1, 5. *Carpolithus Virginienis*.
Figs. 2, 4. *Carpolithus Brookensis*.
Fig. 3. *Carpolithus latus*.
Fig. 6. *Leptostrobus*, sp. undet.
Fig. 7. Ament of conifer.
Fig. 8. *Brachyphyllum*, sp. undet.
Fig. 9. *Brachyphyllum*, sp. undet.
Fig. 10. *Athrotaxopsis grandis*.
Figs. 11, 21. *Cycadosperrnum spatulatum*.
Fig. 12. *Cycadosperrnum acutum*.
Fig. 13. *Cycadosperrnum obovatum*.
Fig. 14. *Capsules*, sp. undet.
Figs. 15, 18, 22. *Athrotaxopsis expansa*.
Fig. 16. Ament of angiosperm f.
Fig. 17. *Carpolithus curvatus*.
Fig. 19. *Cycadosperrnum ellipticum*.
Fig. 20. *Cycadosperrnum angustum*.
- CXXXVI. Fig. 1. *Macrospores*, sp. undet.
Figs. 2-5, 8. Aments of conifers, sp. undet.
Fig. 6. *Carpolithus Brookensis*.
Fig. 7. Pollen sacs, sp. undet.

- PLATE CXXXVI. Fig. 9. *Carpolithus sessilis*.
Figs. 10, 11. *Leptostrobus*, sp. undet.
Fig. 12. *Cycadosperrnum rotundatum*.
Figs. 13, 14. Undetermined plants.
Fig. 15. *Carpolithus mucronatus*.
- CXXXVII. Figs. 1-5. Undetermined plants.
Fig. 6. *Acaciophyllum longifolium*.
- CXXXVIII. Figs. 1-3. *Acaciophyllum longifolium*.
Figs. 4, 6-9. *Acaciophyllum spatulatum*.
Fig. 5. *Acaciophyllum microphyllum*.
Figs. 10-12. *Ctenis imbricata*.
Fig. 13. *Sagenopteris Virginienis*.
Fig. 14. *Conospermites ellipticus*.
- CXXXIX. Fig. 1. *Sagenopteris Virginienis*.
Fig. 2. *Protacephyllum*, sp. undet.
Fig. 3. *Protacephyllum reniforme*.
Fig. 4. *Protacephyllum orbiculare*.
Fig. 5. *Protacephyllum oblongifolium*.
Fig. 6. *Rogersia longifolia*.
Fig. 7. *Sassafras parvifolium*.
- CXL. Figs. 1, 2. *Protacephyllum oblongifolium*.
Fig. 3. *Ficophyllum tenuinerve*.
- CXLI. Fig. 1. *Protacephyllum ovatum*.
Fig. 2. *Ficophyllum tenuinerve*.
- CXLII. Figs. 1, 2. *Protacephyllum ellipticum*.
- CXLIII. Figs. 1, 3. *Ficus Virginienis*.
Fig. 2. *Rogersia angustifolia*.
- CXLIV. Fig. 1. *Ficus Virginienis*.
Fig. 2. *Rogersia longifolia*.
Fig. 3. *Ficophyllum crassinerve*.
- CXLV. Figs. 1, 4. *Ficophyllum tenuinerve*.
Fig. 2. *Ficophyllum serratum*.
Fig. 3. *Ficophyllum crassinerve*.
- CXLVI. Fig. 1. *Ficophyllum crassinerve*.
Figs. 2, 4. *Saliciphyllum ellipticum*.
Fig. 3. *Celastrorhynchium arcinerve*.
Fig. 5. *Celastrorhynchium protoides*.
- CXLVII. Fig. 1. *Sapindopsis cordata*.
Fig. 2. *Ficophyllum tenuinerve*.
Fig. 3. *Sapindopsis elliptica*.
Fig. 4. *Ficophyllum crassinerve*.
- CXLVIII. Figs. 1, 2, 4. *Ficophyllum crassinerve*.
Figs. 3, 5. *Ficus Fredericksburgensis*.
- CXLIX. Figs. 1, 3, 5. *Ficophyllum tenuinerve*.
Fig. 2. *Phyllites pachyphyllus*.
Figs. 4, 8. *Rogersia angustifolia*.
Figs. 6, 7. *Quercophyllum tenuinerve*.
Fig. 9. *Ficophyllum serratum*.
- CL. Fig. 1. *Rogersia longifolia*.
Figs. 2-7. *Rogersia angustifolia*.
Fig. 8. *Saliciphyllum ellipticum*.
Figs. 9, 10. *Vitiphyllum* (*Cissites*) *crassifolium*.
Fig. 11. *Myrica Brookensis*.
Fig. 12. *Saliciphyllum longifolium*.
Fig. 13. *Protacephyllum tenuinerve*.
- CLI. Fig. 1. *Sapindopsis variabilis*.
Figs. 2, 3. *Sapindopsis magnifolia*.
Fig. 4. *Bombax Virginienis*.
- CLII. Figs. 1, 4. *Sapindopsis variabilis*.
Figs. 2, 3. *Sapindopsis magnifolia*.
Fig. 5. *Sassafras cretaceum*, var. *heterolum*.
- CLIII. Fig. 1. *Sapindopsis tenuinervis*.
Fig. 2. *Sapindopsis magnifolia*.
Fig. 3. *Sapindopsis variabilis*.
Fig. 4. *Sapindopsis brevifolia*.

- PLATE CLIV. Figs. 1, 5. *Sapindopsis magnifolia*.
Figs. 2, 4. *Sapindopsis variabilis*.
Fig. 6. *Sapindopsis parvifolia*.
- CLV. Figs. 1, 7. *Sapindopsis brevifolia*.
Figs. 2-5. *Sapindopsis variabilis*.
Fig. 6. *Sapindopsis magnifolia*.
Fig. 8. *Ulmiphyllum Brookense*.
Fig. 9. *Populophyllum reniforme*.
- CLVI. Fig. 1. *Ficophyllum tenuinerve*.
Fig. 2. *Protecephyllum tenuinerve*.
Fig. 3. *Populophyllum reniforme*.
Fig. 4. *Protecephyllum reniforme*.
Fig. 5. *Celastrphyllum obtusidens*.
Fig. 6. *Myracephyllum dentatum*.
Fig. 7. *Protecephyllum dentatum*.
Fig. 8. *Celastrphyllum acutidens*.
Fig. 9. *Quercophyllum grossedentatum*.
Fig. 10. *Myrica Brookensis*.
Fig. 11. *Araliaephyllum aceroides*.
Fig. 12. *Sassafras bilobatum*.
Fig. 13. *Sapindopsis obtusifolia*.
- CLVII. Figs. 1, 7. *Aralia dnbia*.
Fig. 2. *Sterculia elegans*.
Figs. 3, 5, 6. *Juglandiphyllum integrifolium*.
Fig. 4. *Ficophyllum crassinerve*.
- CLVIII. Fig. 1. *Ulmiphyllum tenuinerve*.
Figs. 2, 3. *Sterculia elegans*.
Fig. 4. *Populophyllum crassinerve*.
Fig. 5. *Platanophyllum crassinerve*.
Figs. 6, 7. *Ulmiphyllum crassinerve*.
Fig. 8. *Celastrphyllum Brookense*.
- CLIX. Figs. 1, 2. *Rogersia longifolia*.
Figs. 3-6. *Sapindopsis obtusifolia*.
Fig. 7. *Celastrphyllum Brookense*.
Fig. 8. *Sassafras cretaeaum*, var. *heterolobum*.
Figs. 9, 10. *Araliaephyllum magnifolium*.
- CLX. Figs. 1, 2. *Protecephyllum reniforme*.
Figs. 3-6. *Aristolochiaephyllum crassinerve*.
- CLXI. Figs. 1, 2. *Menispermites Virginicensis*.
- CLXII. Fig. 1. *Hederaephyllum angulatum*.
Fig. 2. *Araliaephyllum aceroides*.
Fig. 3. *Hederaephyllum crenulatum*.
Fig. 4. *Eucalyptophyllum obtusifolium*.
- CLXIII. Figs. 1, 4. *Araliaephyllum obtusilobum*.
Fig. 2. *Araliaephyllum acutilobum*.
Fig. 3. *Sapindopsis brevifolia*.
Fig. 5. *Saliciphyllum ellipticum*.
Fig. 6. *Hymenaea Virginensis*.
Fig. 7. *Ulmiphyllum Brookense*.
Fig. 8. *Aceriphyllum aralioides*.
- CLXIV. Figs. 1, 2. *Ficophyllum eucalyptoides*.
Fig. 3. *Araliaephyllum obtusilobum*.
Fig. 4. *Sassafras bilobatum*.
Fig. 5. *Sassafras cretaeaum*, var. *heterolobum*.
- CLXV. Figs. 1-3. *Taxodium (Glyptostrobus) Brookense*.
Fig. 4. *Laricopsis longifolia*.
Fig. 5. *Williamsonia Virginensis*.
Fig. 6. *Leptostrobus multiflorus*.
- CLXVI. Fig. 1. *Taxodium (Glyptostrobus) ramosum*.
Fig. 2. *Saliciphyllum ellipticum*.
Fig. 3. *Populophyllum hederaforme*.
Figs. 4, 7. *Taxodium (Glyptostrobus) Brookense*.
- PLATE CLXVI. Fig. 5. *Cladophlebis acuta*.
Fig. 6. *Sphenoclepidium Virginicum*.
- CLXVII. Fig. 1. *Taxodium (Glyptostrobus) Brookense*, var. *angustifolium*.
Fig. 2. *Sphenoclepidium Kurrianum*.
Fig. 3. *Taxodium (Glyptostrobus) Brookense*.
Fig. 4. *Phyllocladopsis heterophylla*.
Fig. 5. *Sequoia Reichenbachii*.
Fig. 6. *Carpolithus Brookensis*.
- CLXVIII. Fig. 1. *Frenelopsis parceramosa*.
Fig. 2. *Brachyphyllum*, sp. undet.
Fig. 3. *Dicoidites Buchianus*, var. *obtusifolius*.
Fig. 4. *Nageiopsis subfalcata*.
Figs. 5, 6. *Laricopsis longifolia*.
Fig. 7. *Carpolithus Virginicensis*.
Fig. 8. *Abietites ellipticus*.
Fig. 9. *Brachyphyllum crassicanle*.
- CLXIX. Fig. 1. *Thinnfeldia granulata*.
Fig. 2. *Cladophlebis constricta*.
Fig. 3. *Pecopteris Virginensis*.
Figs. 4, 5, 9. Undetermined stems.
Figs. 6, 7. *Thyrsopteris rarineris*.
Fig. 8. *Callitris*, sp. undet.
Fig. 10. *Celastrphyllum denticulatum*.
- CLXX. Fig. 1. *Thyrsopteris divaricata*.
Fig. 2. *Pulozanites subfalcatus*.
Fig. 3. *Zamites ovalis*.
Fig. 4. *Pinus*, sp. undet.
Figs. 5, 6. *Pecopteris strictinervis*.
Fig. 7. *Acaciophyllum variabile*.
Fig. 8. *Rhizome of Equisetum*, sp. undet.
Fig. 9. *Podozanites subfalcatus*.
Fig. 10. *Acrostichopteris longipennis*.
Fig. 11. *Acrostichopteris densifolia*.
- CLXXI. Figs. 1, 5, 7. *Acrostichopteris longipennis*.
Figs. 2, 6. *Acrostichopteris densifolia*.
Figs. 3, 4. *Acrostichopteris parvifolia*.
- CLXXII. Figs. 1, 4. *Protecephyllum dentatum*.
Fig. 2. *Celastrphyllum tenuinerve*.
Figs. 3, 6. *Celastrphyllum latifolium*.
Fig. 5. *Saliciphyllum parvifolium*.
Fig. 7. *Celastrphyllum denticulatum*.
Fig. 8. *Menispermites tenuinervis*.
Figs. 9, 10. *Celastrphyllum obovatum*.
Figs. 11, 12. *Vitiphyllum (Cissites) parvifolium*.
Fig. 13. *Acrostichopteris densifolia*.
Fig. 14. *Acrostichopteris parvifolia*.
- CLXXIII. Figs. 1-9. *Vitiphyllum (Cissites) multifolium*.
- CLXXIII. Fig. 10. *Ficophyllum crassinerve*.
Fig. 11. Undetermined plant.
Figs. 12, 14. *Protecephyllum dentatum*.
Fig. 13. *Celastrphyllum latifolium*.
- CLXXIV. *Tysonia Marylandica*.
CLXXV. *Tysonia Marylandica*.
CLXXVI. *Tysonia Marylandica*.
CLXXVII. *Tysonia Marylandica*.
CLXXVIII. *Tysonia Marylandica*.
CLXXIX. *Tysonia Marylandica*.
CLXXX. *Tysonia Marylandica*.

PLATES.



PLATE I.

PLATE I.

		Page.
Figs. 1-6,	8. <i>EQUISETUM VIRGINICUM</i> , sp. nov	63
	1. Much-branched form of average dimensions	63
	1 ^a . Magnified portion, to show normal form of teeth	63
	1 ^b . Magnified portion, to show a blunter form of teeth	63
	1 ^c . Is 1 ^a still more magnified and more diverging at the summit than the normal form.	63
	2. One of the smallest branches seen	63
	3. Three branches, probably primary, with many secondary ones	63
	4. Several large primary? branches	63
	5. Primary? branch, with a branching secondary?	63
	6. Profusely branching secondary? branch	63
	8. Form showing curious and copious branching	63
FIG.	7. <i>EQUISETUM LYELLI</i> Mantell	65
	7. Probably <i>E. LYELLI</i> Mantell, partially decorticated	65

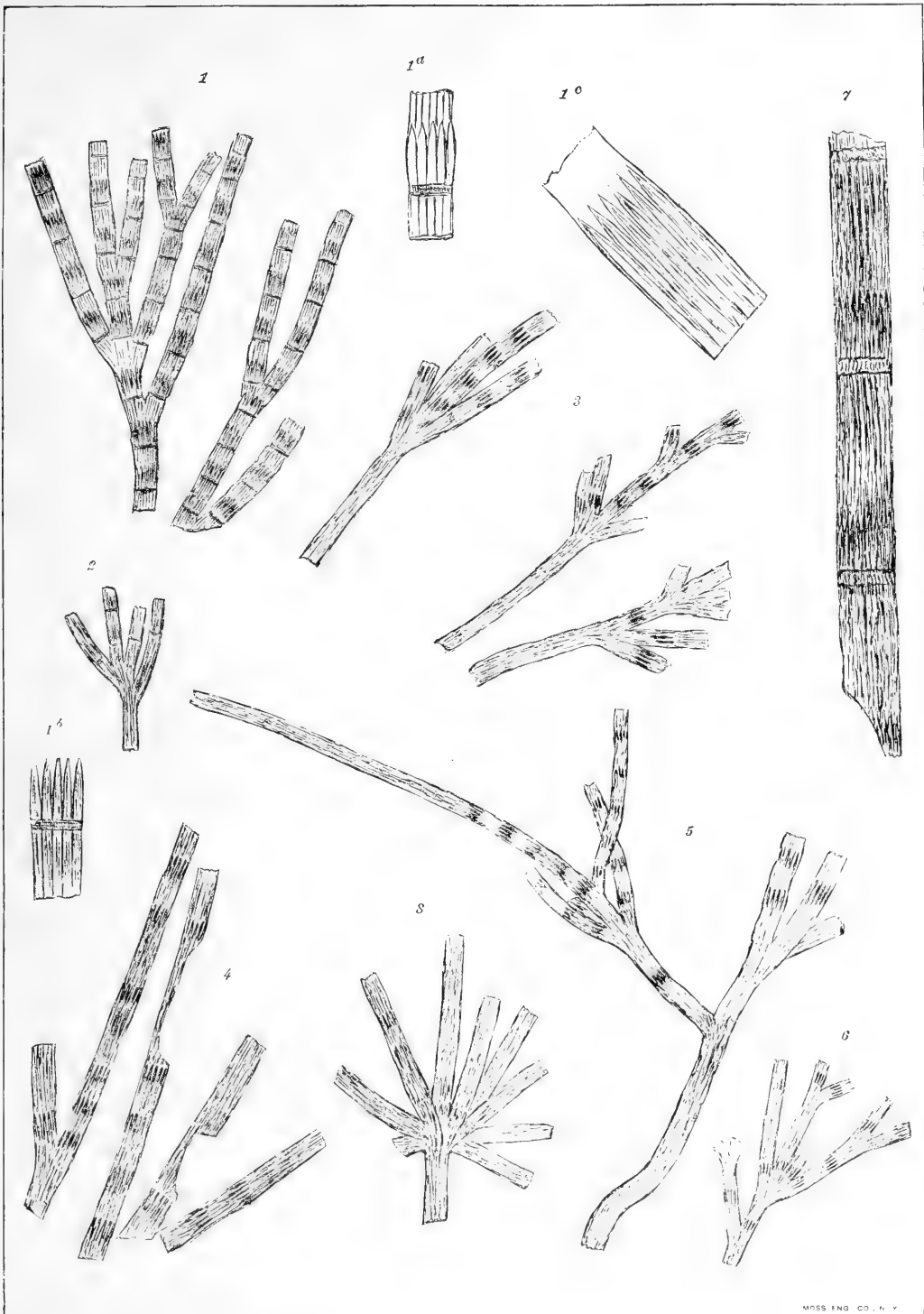

PLATE II.

PLATE II.

		Page.
	FIGS. 1-3, 6, 7, 9. <i>EQUISETUM VIRGINICUM</i> , sp. nov	63
	1, 3. Apparently portions of the main stem, showing six teeth	63
	2, 9. Apparently portions of rhizomes, with imperfect buds	63
	6. Large, much-branched primary ? branch	63
	7. Distorted irregularly branching form	63
FIG.	4, 5. <i>EQUISETUM LYELLI</i> Mantell.	65
	4. Fragment of a small stem	65
	5. Several fragments probably of the same plant	65
	8. Rhizome ? of undetermined <i>Equisetum</i>	65
	8 ^a . Portion of 8 magnified	65
FIG.	10. <i>EQUISETUM MARYLANDICUM</i> , sp. nov	65
	10. Portion of a branching stem	65
	10 ^a . Portion of a branch magnified to show the sheath	65
FIG.	11. <i>CLADOPHLEBIS CONSTRUCTA</i> , sp. nov	68
	11. Probably the upper part of the frond	68
	11 ^a . Pinna from the lower part of the specimen, magnified to show details of ner- vation	68
	11 ^b . Magnified pinna or pinnule from the upper portion of the specimen	68

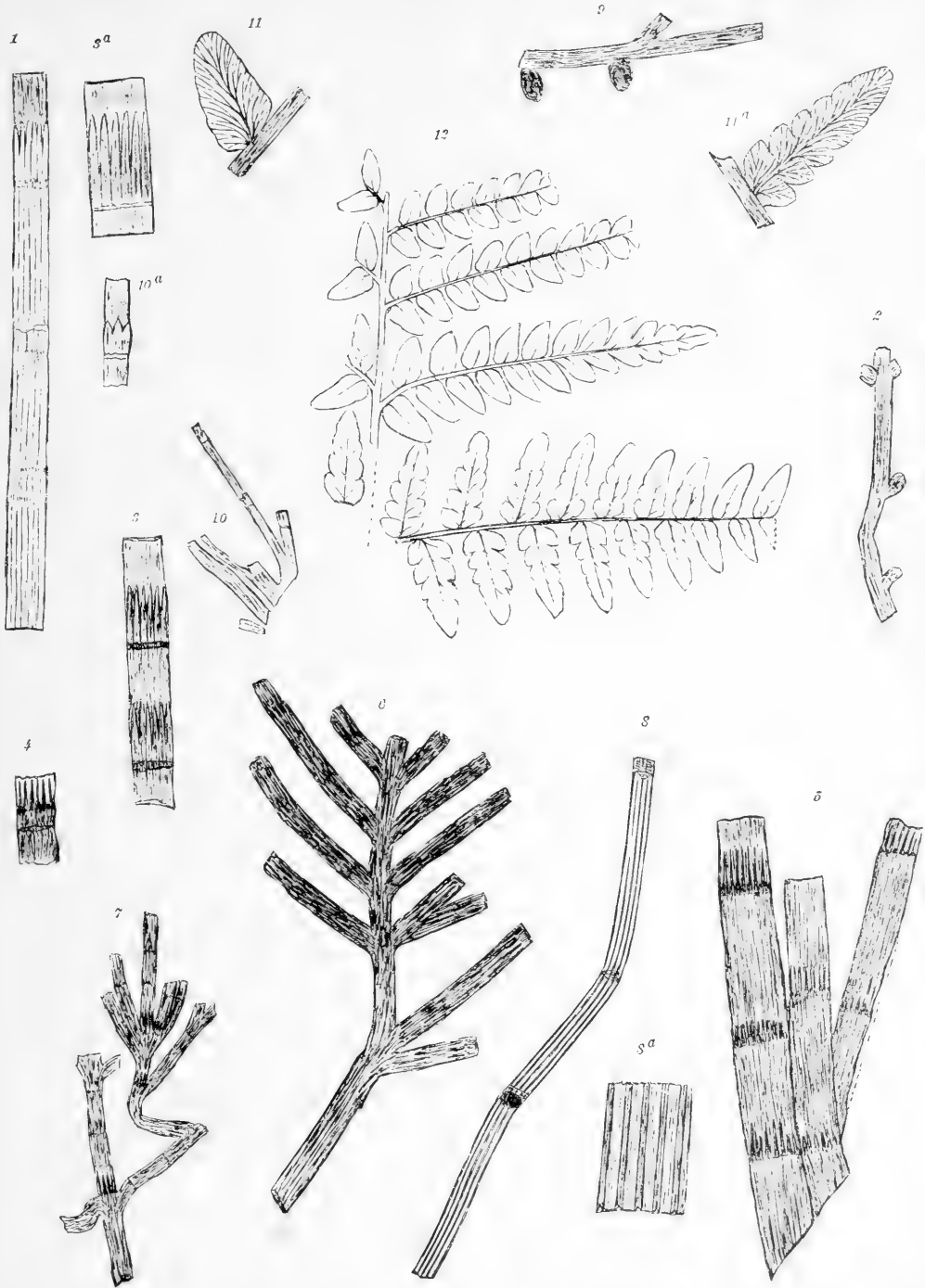

PLATE III.

PLATE III.

		Page.
FIG. 1.	1. <i>CLADOPHLEBIS LATIFOLIA</i> , sp. nov.	69
	1. Upper part of a frond or compound pinna	69
	1 ^a . Pinnule from the lower part of 1 magnified to show nervation	69
	1 ^b . Pinnule from the upper part of 1 magnified to show nervation	69
FIG. 2.	2. <i>CLADOPHLEBIS CONSTRICTA</i> , sp. nov.	68
	2. Portion of a compound pinna	68
FIGS. 3-8.	3. <i>CLADOPHLEBIS VIRGINIENSIS</i> , sp. nov.	70
	3. Fragment of a large compound pinna or of the frond	70
	4. Portion of an ultimate pinna	70
	4 ^a . Pinnule of 4 magnified to show nervation	70
	5. Fragment of a pinna with opposite pinnules	70
	5 ^a . Pinnule of 5 magnified to show nervation	70
	6. Portion of a compound pinna? with short pinnules	70
	7. Fragment of a pinna with somewhat abnormal pinnules	70
	7 ^a . Pinnule of 7 magnified	70
	8. Fragment of a pinna with much-branched nerves	70
	8 ^a . Pinnule of 8 magnified to show nervation	70

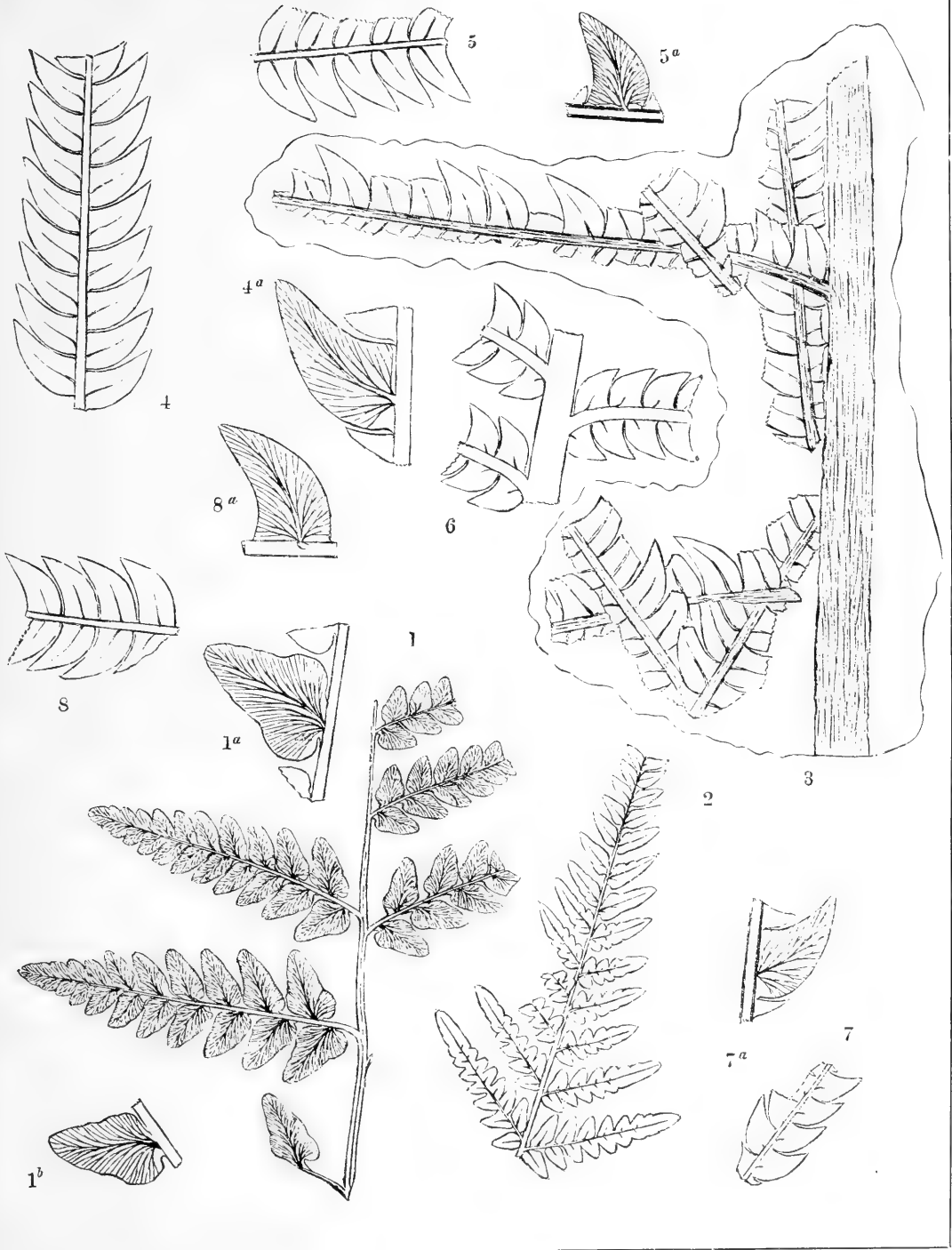
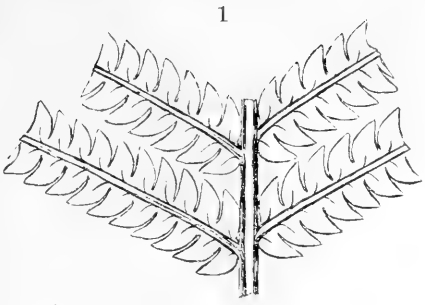

PLATE IV.

PLATE IV.

		Page.
FIGS. 1, 3-6.	CLADOPHLEBIS VIRGINIENSIS, sp. nov.	70
	1. Small form, probably from the upper part of the frond	70
	1 ^a . Pinnule of 1 magnified to show nervation	70
	3. Abnormal form, possibly not C. VIRGINIENSIS	70
	3 ^a . Portion of 3 magnified	70
	4. Portion of an ultimate pinna with obtuse pinnules and a rachis with marginal ridges	70
	4 ^a . Pinnules from the lower part of 4, magnified	70
	4 ^b . Pinnules from the upper part of 4, magnified	70
	3, 5, 6. Portions of pinnae with undulate pinnules	70
FIG.	2. CLADOPHLEBIS DENTICULATA, sp. nov.	71
	2. Fragments of two pinnae	71
	2 ^a . Pinnule of 2 magnified to show nervation	71
FIG.	7. CLADOPHLEBIS PARVA, sp. nov.	73
	7. Probably the upper portion of a compound pinna	73
	7 ^a . Pinnule of 7 magnified	73
FIG.	8. CLADOPHLEBIS FALCATA, sp. nov.	72
	8. Portion of an ultimate pinna with undulate margins	72
	8 ^a . Pinnule of 8 magnified	72



1

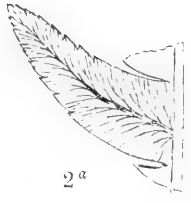

2^a



2

1^a



5



7

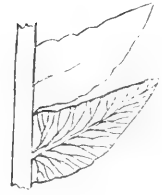

3^a



3

8^a



6

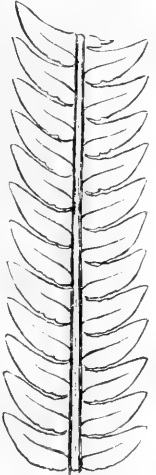

7^a



4^b

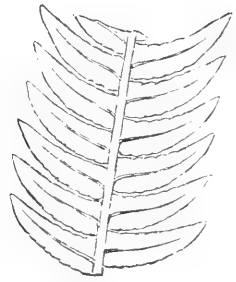

8

4^a

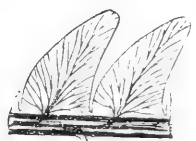

4

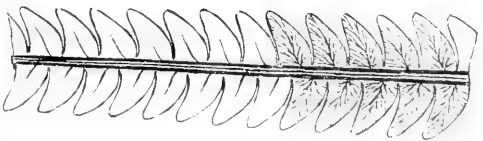

PLATE V.

PLATE V.

		Page.
Figs. 1-6.	CLADOPHLEBIS FALCATA, sp. nov.	72
	1. Portion of the frond or of a compound pinna	72
	1 ^a . Pinnule of 1 magnified to show nervation	72
	2. Terminal portion of an ultimate pinna	72
	3. Pinnules with undulate margins, probably from the upper part of the frond	72
	4. Similar to 3.	72
	4 ^a . Pinnule of 4 magnified to show nervation	72
	5. Tip of an ultimate pinna with obtuse pinnules; possibly this is a different plant	72
	5 ^a . Pinnule of 5 magnified to show nervation	72
	6. Fragment of a pinnule.	72
	6 ^a . Fragment 6 magnified to show nervation	72
FIG.	7. CLADOPHLEBIS ACUTA, sp. nov.	74
	7. Ultimate pinna with unusually large pinnules	74
	7 ^a . Pinnule of 7 magnified to show nervation	74

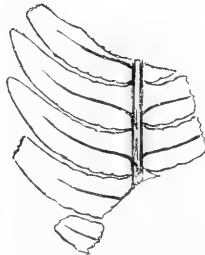
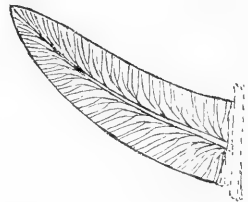
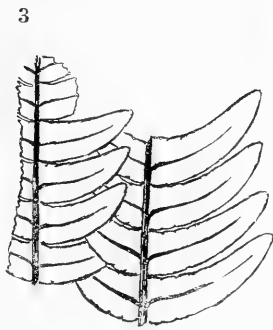
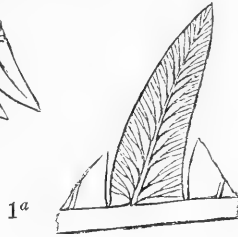
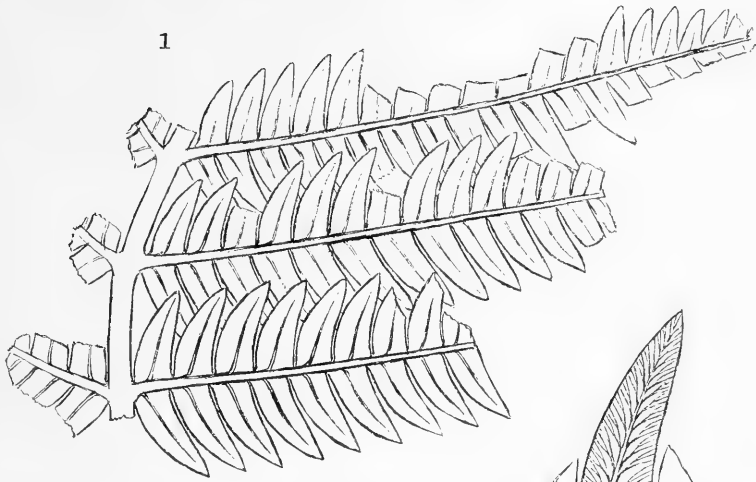

PLATE VI.

P L A T E V I .

	Page.
FIGS.	1-3. CLADOPHLEBIS PARVA, sp. nov. 73
	1. Upper part of a compound pinna or of the frond 73
	1 ^a . Portion of 1 magnified to show nervation 73
	2. Probably a portion of the middle part of a compound pinna or of the frond . 73
	2 ^a . Pinnules of 2 magnified to show nervation 73
	3. Largest fragment seen, probably a compound pinna. 73
	3 ^a . Pinnules of 3 magnified to show nervation 73
FIG.	4. CLADOPHLEBIS LATIFOLIA, sp. nov. 69
	4. Probably a portion from the summit of the frond or of a compound pinna.... 69
FIGS. 5, 6, 8-14.	CLADOPHLEBIS CONSTRICTA, sp. nov. 68
	5. Pinna or pinnule with undulate margins from near the summit of the frond or of a compound pinna. 68
	5 ^a . Pinna 5 magnified to show nervation 68
	6. Upper part of the frond or of a compound pinna 68
	6 ^a . Pinnules of 6 magnified to show nervation 68
	8. Summit of an ultimate pinna 68
	8 ^a . Pinnule of 8 magnified to show nervation 68
	9. Abnormal pinnules unusually remote; possibly a different plant 68
	9 ^a . Pinnule of 9 magnified to show nervation 68
	10. Summit of the frond or of a compound pinna. 68
	11. Upper portion of a comparatively large compound pinna or of the frond.... 68
	11 ^a . Pinnules from the lower part of 11 68
	11 ^b . Pinnules from the upper part of 11 magnified to show nervation 68
	12, 13, 14. Somewhat abnormal forms; possibly representing a different plant from 11.. 68
FIG.	7. CLADOPHLEBIS FALCATA, sp. nov. 72
	7. Pinna with pinnules of the largest size. 72
	7 ^a . Portion of a pinnule of 7 magnified to show nervation 72

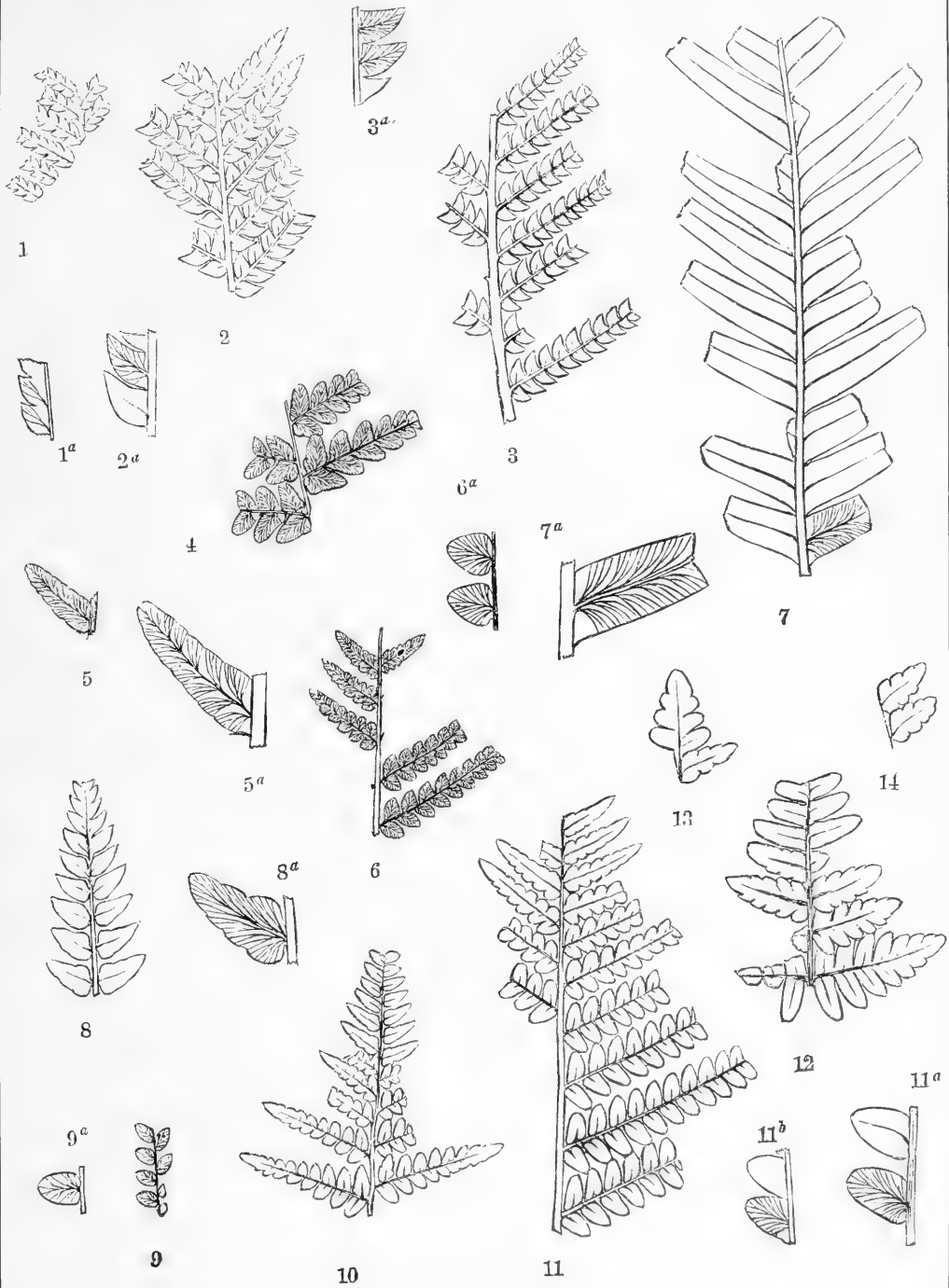
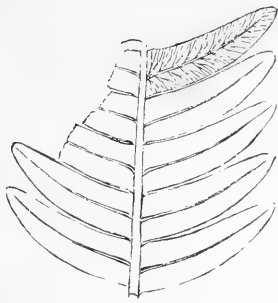

PLATE VII.

PLATE VII.

	Page.
FIGS. 1, 2. <i>CLADOPHLEBIS FALCATA</i> , sp. nov.	72
1. Ultimate pinna with large and very obtuse pinnules, probably from the upper part of the frond.	72
1 ^a . Pinnule of 1 magnified to show nervation.	72
2. Probably a portion of a compound pinna, with somewhat abnormal pinnules; possibly a distinct species.	72
2 ^a . Pinnule of 2 magnified to show nervation.	72
FIGS. 3-5. <i>CLADOPHLEBIS OBLONGIFOLIA</i> , sp. nov.	74
3. Ultimate pinna with entire pinnules.	74
3 ^a . Pinnule of 3 slightly magnified to show nervation.	74
4. Pinnules of form from Fredericksburg slightly magnified.	74
5. Pinna with crenulate pinnules.	74
5 ^a . Portion of a pinnule of 5 magnified to show nervation.	74
FIG. 6. <i>CLADOPHLEBIS ACUTA</i> , sp. nov.	74
6. Portion of an ultimate pinna.	74
6 ^a . Pinnule of 6 magnified to show nervation.	74
FIG. 7. <i>CLADOPHLEBIS DENTICULATA</i> , sp. nov.	71
7. Portion of an ultimate pinna.	71
7 ^a . Pinnule of 7 magnified to show nervation.	71
FIGS. 8-11. <i>ANGIOPTERIDIUM AURICULATUM</i> , sp. nov.	113
8. Probably a portion of a compound pinna.	113
9. Probably a portion of a compound pinna showing keeled rachis.	113
10. Portion of a pinnule.	113
10 ^a . Nerves from the lower part of 10 magnified.	113
10 ^b . Nerves from the upper part of 10 magnified.	113
11. Portion of a pinnule showing nerves.	113



1

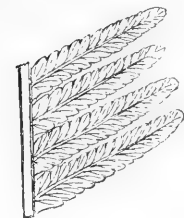

5



5^a



11



3

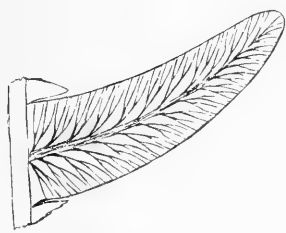

1^a

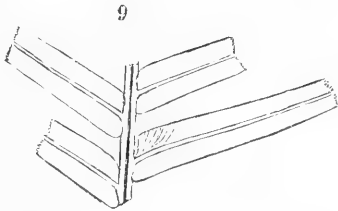

9



10^b

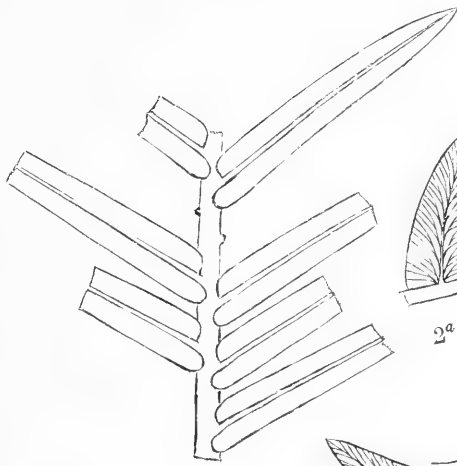

8



2^a

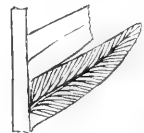

3^a



10



10^a

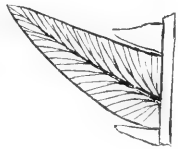

6^a

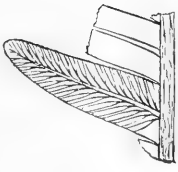

4

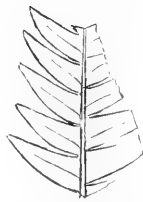

6

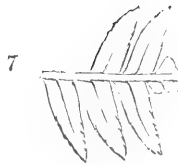

7

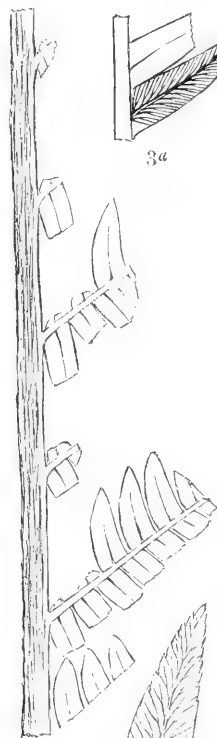

2



7^a



PLATE VIII.

PLATE VIII.

	Page.
FIGS. 1-7. <i>PECOPTERIS VIRGINIENSIS</i> , sp. nov.	82
1. Pinna with unusually long pinnules, from Fredericksburg	82
1 ^a . Pinnule of 1 magnified to show nervation	82
2. A compound pinna, or a part of the frond, from road-side near Potomac Run	82
2 ^a . Portion of a pinnule from the lower part of the specimen magnified	82
2 ^b . A pinnule from the upper part magnified	82
3. Pinna from Fredericksburg	82
3 ^a . Pinnule of 3 magnified to show nervation	82
4. Pinna from Fredericksburg	82
5. Upper portion of a pinna from 72d mile-post, near Brooke	82
6. Pinna from road-side near Potomac Run	82
7. Pinna from road-side near Potomac Run	82
7 ^a . Pinnule of the same magnified to show nervation	82



1

4

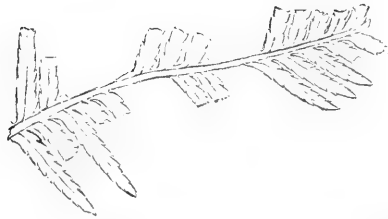

3

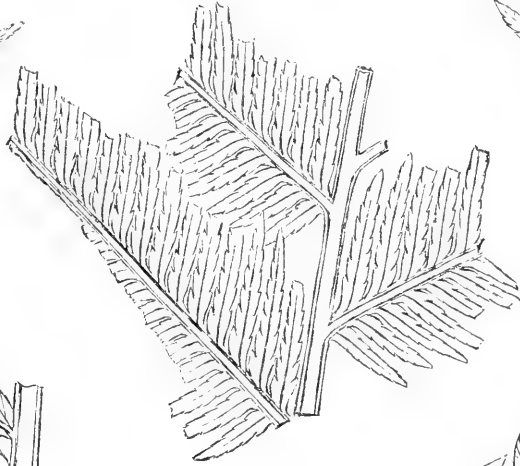

2

3^a



2^a

7



1^a



2^b



5



7^a

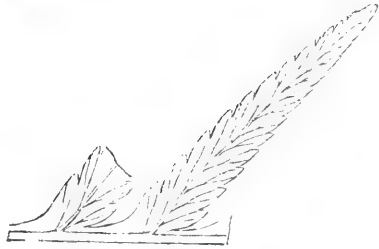

6

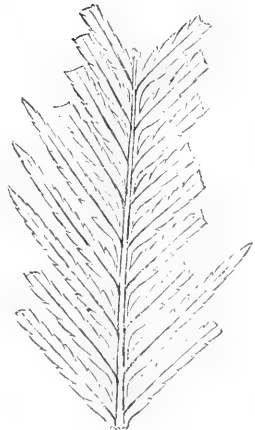



PLATE IX.

PLATE IX.

	Page.
FIGS. 1-6. <i>PECOPTERIS VIRGINIENSIS</i> , sp. nov.	82
1. Compound pinna from Fredericksburg	82
1 ^a . Pinnule of 1 magnified to show nervation	82
2. Pinna from fishing hut above Dutch Gap Canal	82
2 ^a . Pinnule of 2 magnified to show nervation	82
3. Pinna from red clay ball in Dutch Gap Canal	82
4. Pinna from fishing hut above Dutch Gap Canal	82
5. Pinna from road-side near Potomac Run	82
6. Pinna from fishing hut above Dutch Gap Canal	82
FIGS. 7-9. <i>CLADOPHEBIS CRENATA</i> , sp. nov.	75
7. Portion of the frond or of a primary pinna	75
7 ^a . Pinnule of 7 magnified to show nervation	75
8. Portion of the frond or of a primary pinna	75
8 ^a . Pinnules of 8 magnified to show nervation	75
9. Portion of an ultimate pinna, with unusually broad pinnules	75



1

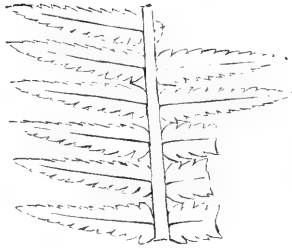

2



2^a



3



1^a



6



5



4

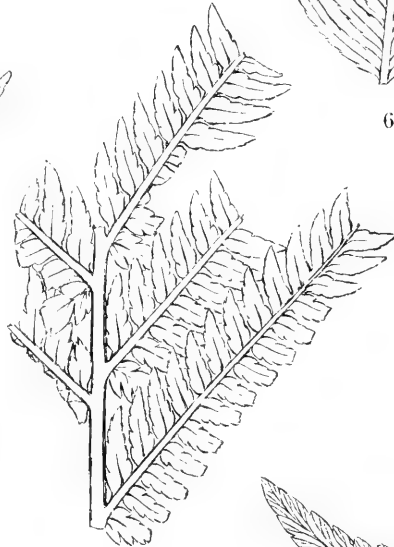

7



7^a



8^a

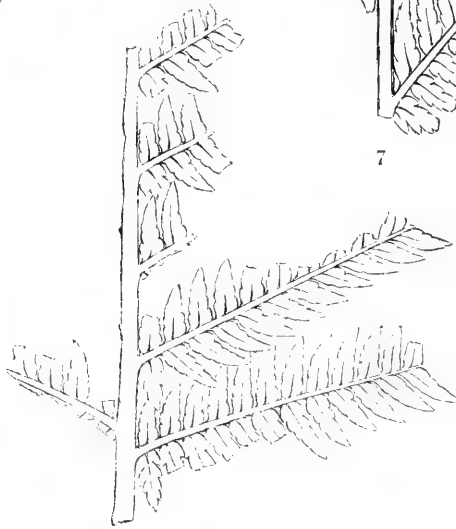

8



9



PLATE X.

PLATE X.

	Page.
FIGS. 1, 2. <i>CLADOPHEBIS CRENATA</i> , sp. nov.	75
1. Portion of the frond or of a compound pinna.	75
1 ^a . Pinnule of 1 magnified to show nervation.	75
2. Portion of the frond, or of a compound pinna, with opposite pinnae; possibly a distinct species.	75
2 ^a . Pinnule from the upper part of 2 magnified.	75
FIGS. 3, 4. <i>CLADOPHEBIS INCLINATA</i> , sp. nov.	76
3. Portion of the frond, or of a compound pinna, with small pinnules, showing opposition of pinnae.	76
3 ^a . Pinnule of 3 magnified to show nervation.	76
4. Portion of the frond or of a compound pinna.	76
FIGS. 5, 8. <i>CLADOPHEBIS</i> , sp. ?	76
5, 8. Fragments of ultimate pinnae, showing in the pinnules no lateral nerves.	77
5 ^a . An enlarged pinnule of 5.	67
FIGS. 6, 7. <i>CLADOPHEBIS ACUTA</i> , sp. nov.	46
6. Several detached pinnae.	74
6 ^a . Pinnule of the same magnified to show nervation.	74
7. Pinna showing abnormal lateral nerves in the pinnules.	74
7 ^a . Pinnule of 7 magnified to show nervation.	74
FIG. 9. <i>ASPLENIUM DUBIUM</i> , sp. nov. ?	109
9. Small fragment of an ultimate pinna, a pinnule of which is magnified in 9 ^a	109

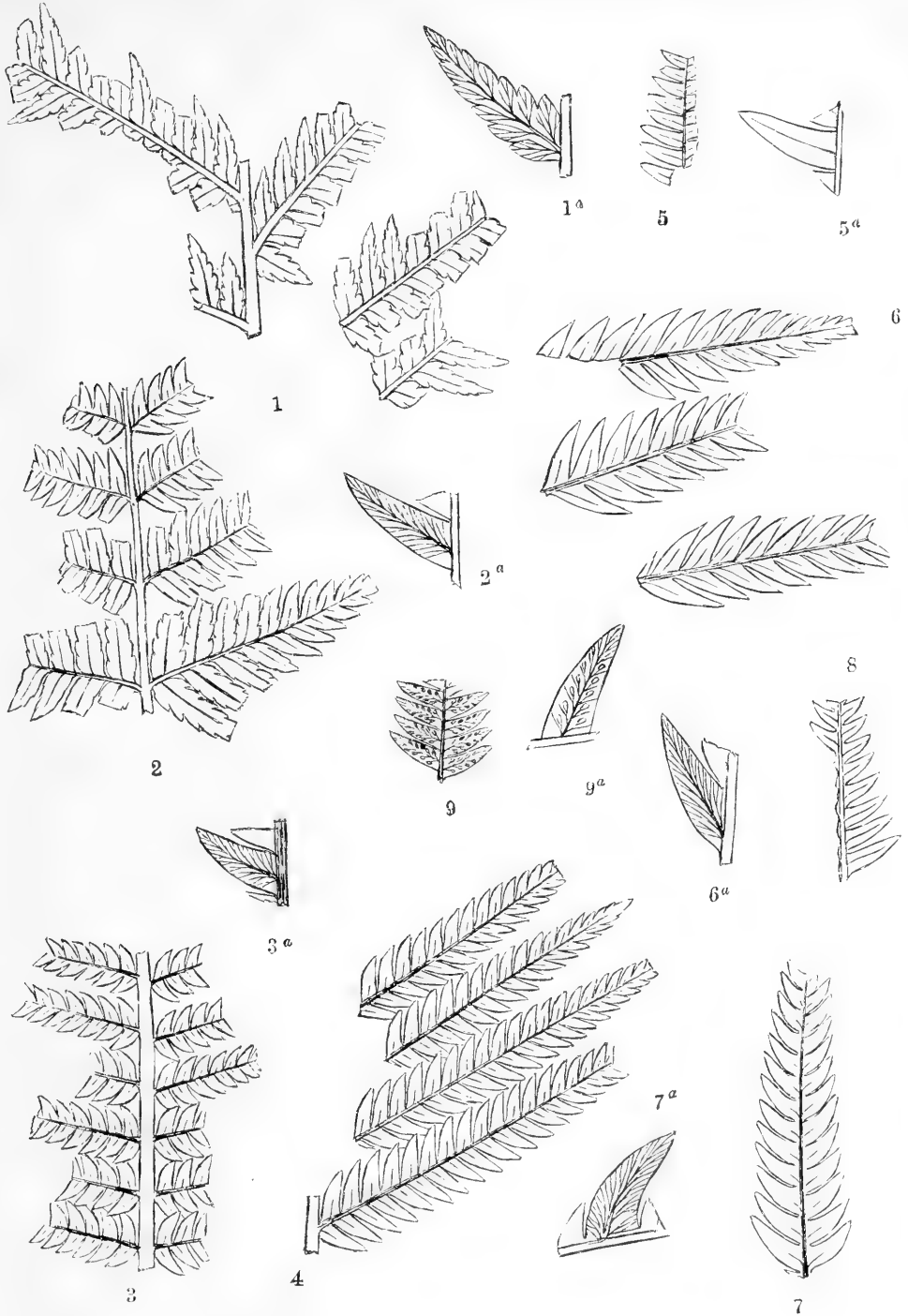

PLATE XI.

P L A T E X I .

	Page.
FIGS. 1-6. <i>ASPIDIUM FREDERICKSBURGENSE</i> , sp. nov.	94
1. Portion of a compound pinna or of the frond	94
1 ^a . Pinnule of 1 magnified to show the nervation	94
2. Portion of an ultimate pinna showing sori	94
2 ^a . Pinnule of 2 magnified to show the sori	94
2 ^b . A sorus still more magnified	94
3. Fragment of a very long ultimate pinna	94
3 ^a . Magnified pinnule of 3	94
4. Fragment of an ultimate pinna with distant pinnules	94
4 ^a . Pinnule of 4 magnified	94
5. Fragments of ultimate pinnae with entire margins	94
6. Fragment showing unusually small pinnules	94
6 ^a . Pinnule of 6 magnified to show nervation	94
FIGS. 7, 8. <i>CLADOPHELEIS ACUTA</i> , sp. nov.	74
7. A form with unusually long and slender pinnules	74
7 ^a . Pinnule of 7 magnified to show nervation	74
8. Portion of the frond or of a compound pinna	74
8 ^a . Magnified pinnule of 8	74

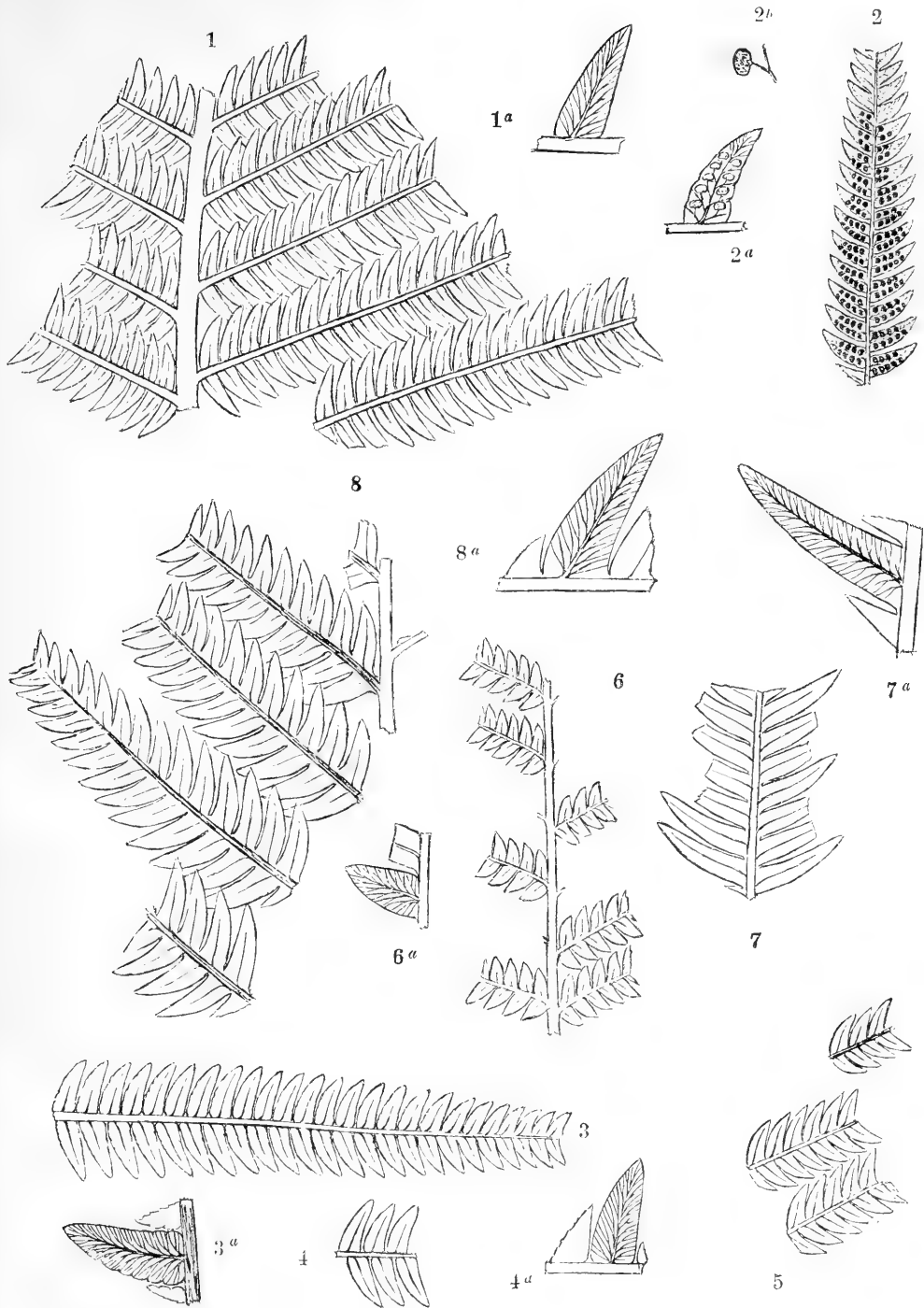

PLATE XII.

P L A T E X I I .

	Page.
FIGS. 1-6. <i>ASPIDIUM FREDERICKSBURGENSE</i> , sp. nov.	94
1. Portion of the frond, or of a very large compound pinna	94
1 ^a . Magnified pinnule from the lower part of 1, showing nervation	94
2. Portion of a compound pinna from the lower part of the frond, showing lobed and toothed pinnules	94
2 ^a . Magnified pinnules of 2	94
3. Fragment of a large pinna, or of the frond, showing toothed pinnules	94
3 ^a . Magnified pinnules of 3	94
4. Fragment of an ultimate pinna with unusually large toothed pinnules	94
4 ^a . Magnified pinnule of 4	94
5. Fragment of an ultimate pinna with broad crenate pinnules	94
5 ^a . Magnified pinnule of 5, showing nervation	94
6. Fragment of a pinna with unusually long crenate pinnules, probably from the upper part of the frond	94
6 ^a . Pinnule of 6 magnified to show nervation	94

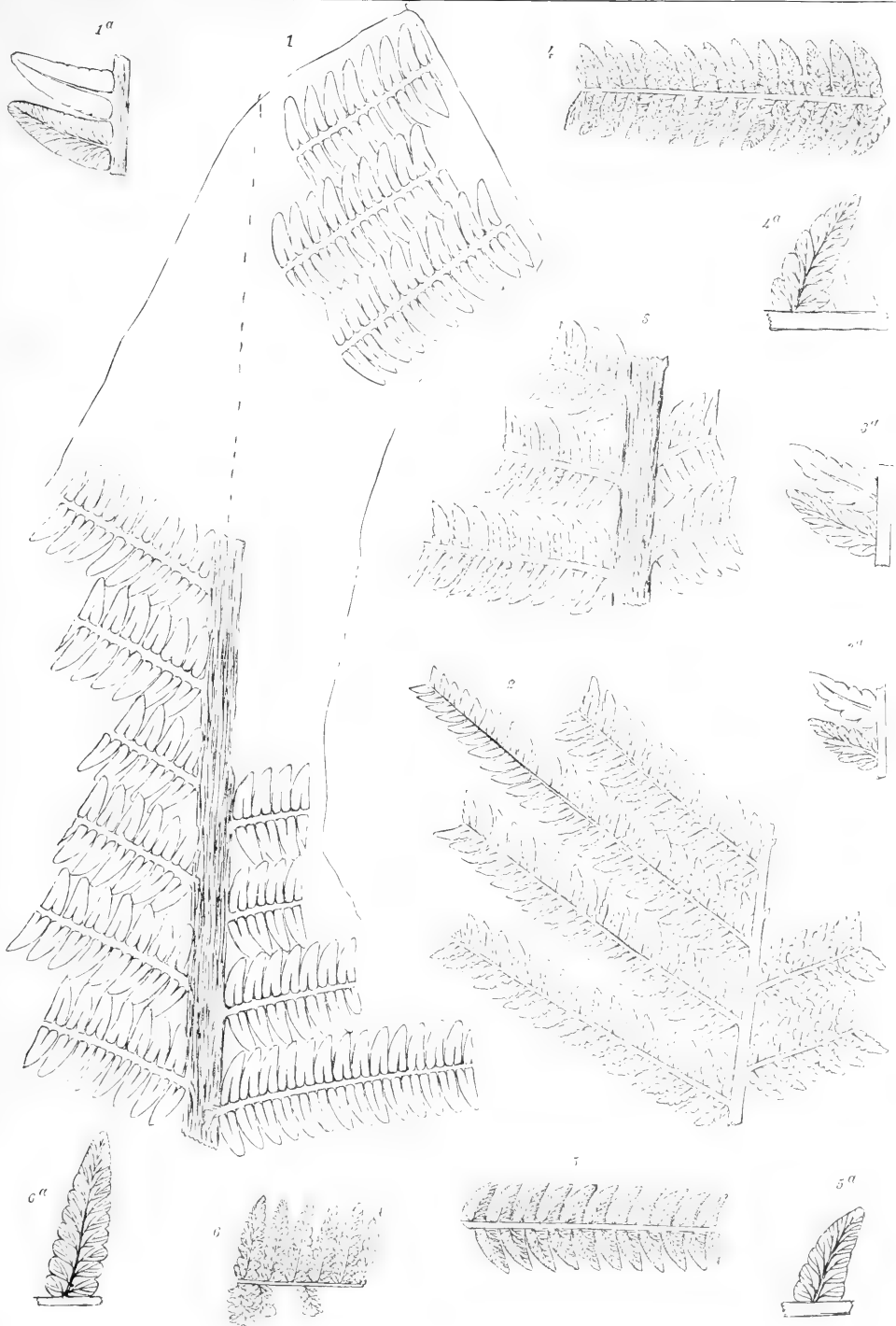

PLATE XIII.

PLATE XIII.

	Page.
FIGS. 1-3. CLADOPHLEBIS CRENATA, sp. nov.	75
1. Pinna with rather large, deeply lobed pinnules	75
1 ^a . Pinnule of 1 magnified, to show nervation	75
2. Small pinnules from the upper part of the frond	75
2 ^a . Pinnule of 2 magnified	75
3. Portion of a pinna	75
3 ^a . Pinnule of 3 magnified	75
FIGS. 4, 5. CLADOPHLEBIS DISTANS, sp. nov.	77
4. Portion of a compound pinna or of the frond	77
4 ^a . Pinnules of 4 magnified	77
5. Detached pinna	77
5 ^a . Pinnules of 5 magnified	77
FIGS. 6-8. PECOPTERIS STRICTINERVIS, sp. nov.	84
6. Portion of a compound pinna with somewhat abnormal pinnules and nervation ..	84
6 ^a . Magnified pinnules of 6	84
7. Portion of a compound pinna with denticulate pinnules	84
7 ^a . Magnified pinnules of 7	84
8. Portion of a pinna from the lower part of the frond	84
8 ^a . Magnified pinnules of 8	84
FIGS. 9, 10. ASPIDIUM ELLIPTICUM, sp. nov.	95
9. Portion of a compound pinna or of the frond	95
9 ^a . Magnified base of a pinnule	95
9 ^b . Magnified pinnule with sori	95
9 ^c . Sorus still more magnified, giving indication of sporangia around the margin	95
10. Portion of a pinna of probably the same plant as 9, probably the upper part, from bank near Brooke.	95

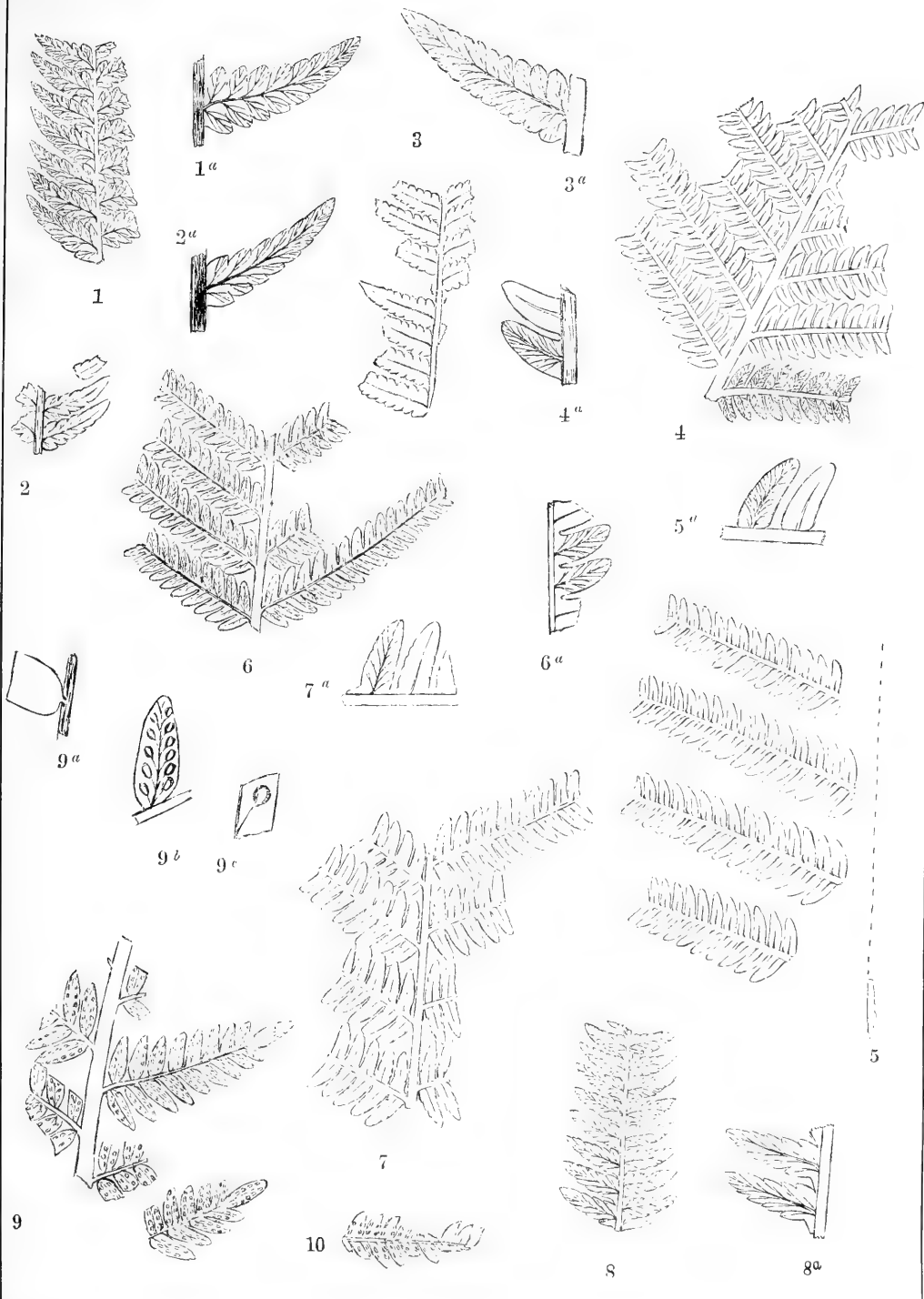

PLATE XIV.

PLATE XIV.

	Page.
FIGS. 1-5. <i>ASPIDIUM HETEROPHYLLUM</i> , sp. nov.	96
1. Fragment of a large primary pinna or of the frond	96
1 ^a . Ultimate pinna of 1, from the lower part of a secondary pinna, magnified to show nervation	96
1 ^b . Magnified pinna or pinnule from higher up on the secondary pinna	96
1 ^c . Magnified pinnule from near the summit of the secondary pinna	96
1 ^d . Magnified pinnule from the summit of the secondary pinna	96
2. Portion of a large secondary pinna	96
3. Summit of a secondary pinna	96
4. Portion of an ultimate pinna	96
4 ^a . Magnified pinnules of 4	96
5. Portion of the summit of a primary pinna or of the frond	96

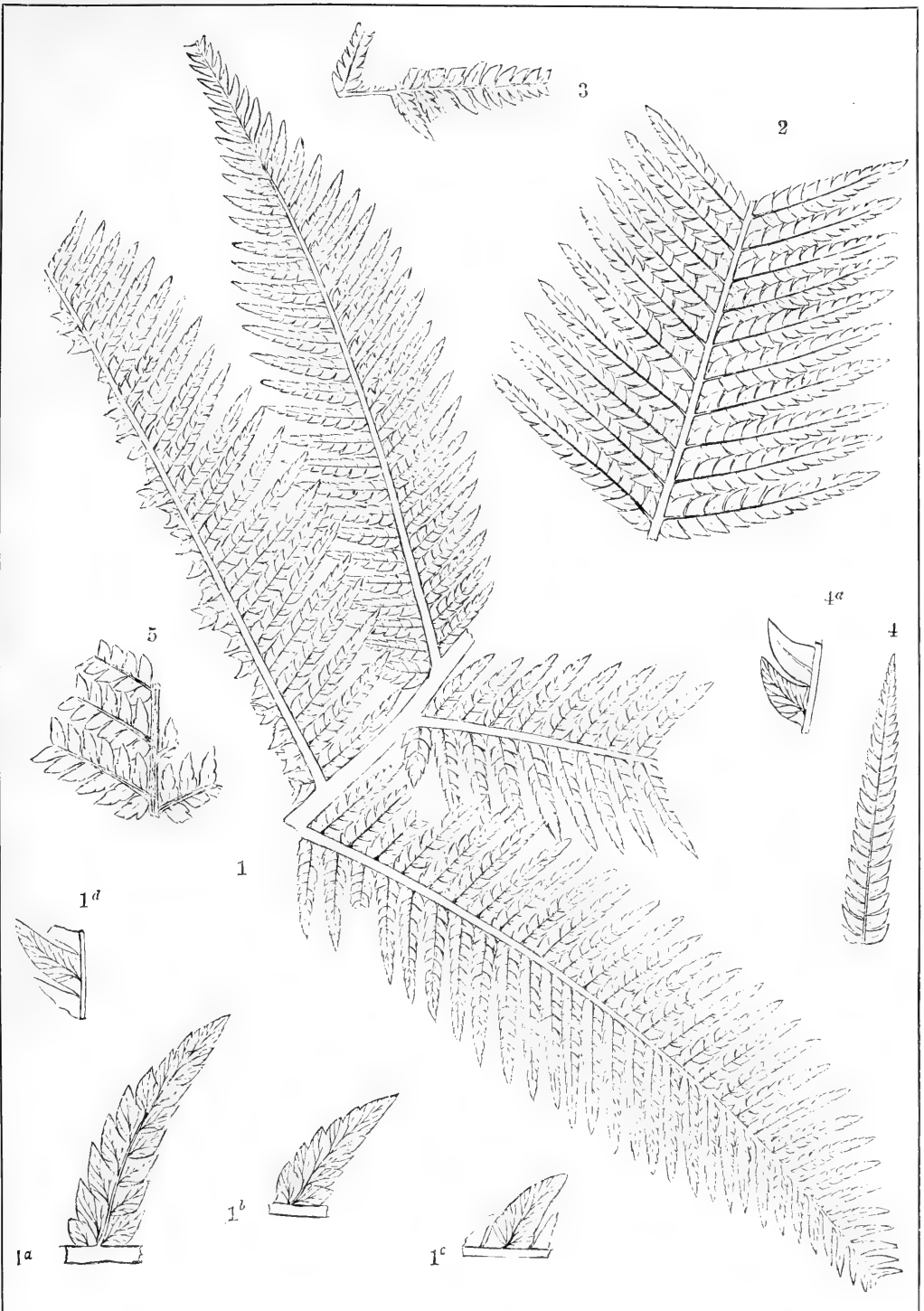



PLATE XV.

PLATE XV.

		Page.
FIGS. 1-5.	ASPIDIUM HETEROPHYLLUM, sp. nov.	96
	1. Portion of a fructified ultimate pinna.	96
	1 ^a . Magnified pinnule of 1, to show sori and nerves.	96
	2. Portion of the upper part of a primary pinna or of the frond.	96
	3. Portion of a secondary pinna.	96
	3 ^a . Pinnules of 3 magnified.	96
	4. Portion of a secondary pinna from low down on the plant.	96
	4 ^a . Magnified pinnules of 4.	96
	5. Portion of a fructified secondary pinna.	96
	5 ^a . Pinnules of 5 magnified, to show sori and nervation.	96
FIG.	6. CLADOPHEBIS, species undetermined.	77
	6. Small fragment of a pinna from bank near Brooke.	77
	6 ^a . Pinnule of 6 magnified.	77
FIG.	7. ASPIDIUM VIRGINICUM, sp. nov.	97
	7. Small fragment of an ultimate pinna.	97
	7 ^a . Magnified pinnule of 7.	97
FIG.	8. PECOPTERIS OVATODENTATA, sp. nov.	85
	8. Portion of an ultimate pinna.	85
	8 ^a . Pinnule of 8 magnified.	85

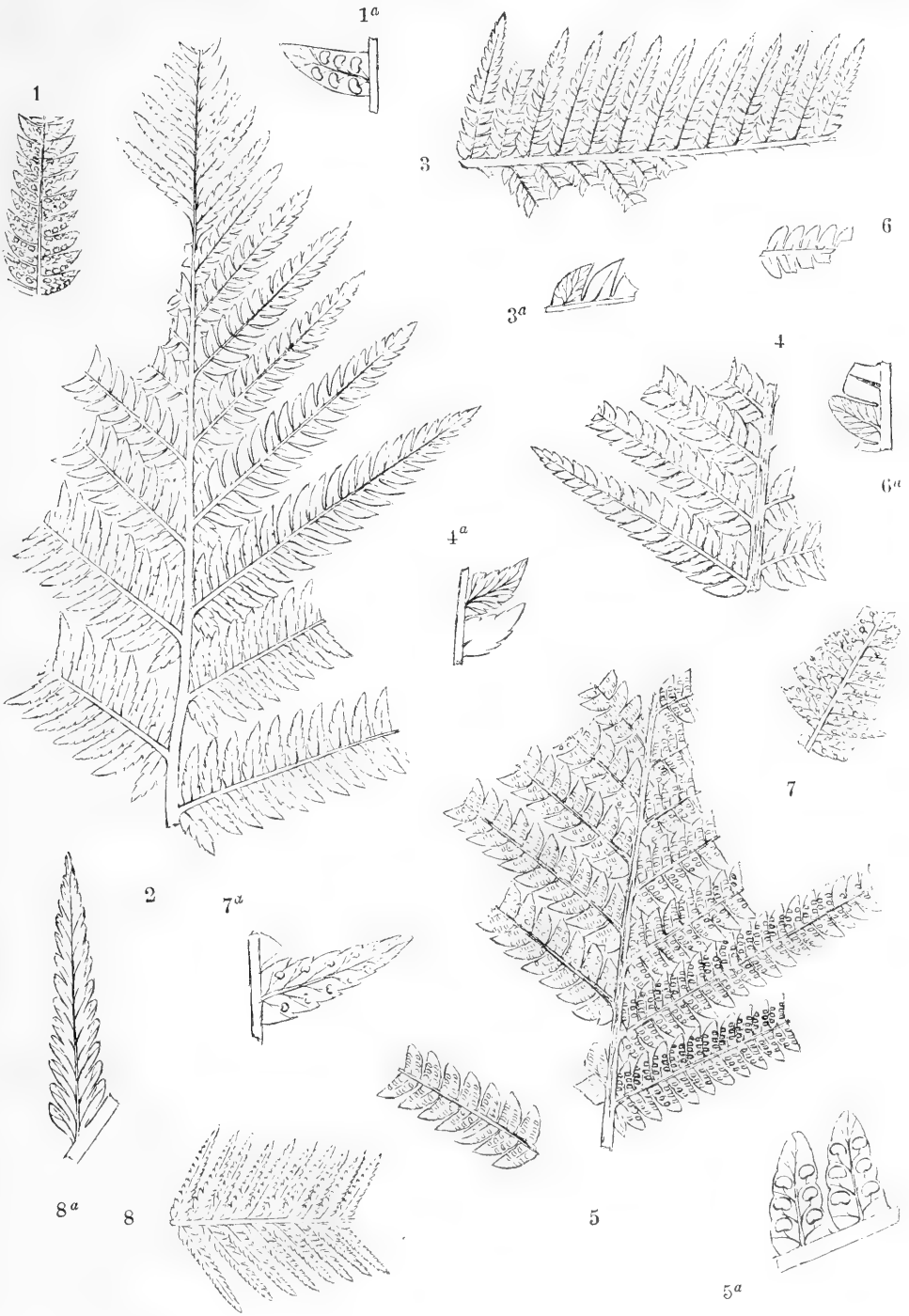



PLATE XVI.

PLATE XVI.

		Page.
FIGS. 1, 3, 8.	ASPIDIUM ANGUSTIPINNATUM, sp. nov.	98
	1. Fragment of an ultimate pinna	98
	3. Portion of a large primary pinna, or of the frond, slightly restored	98
	3 ^a . Pinnules from the lower part of 3 magnified	98
	3 ^b . Pinnules from the upper part of 3 magnified	98
	8. Portion of an ultimate pinna from hill-side near Potomac Run	98
	8 ^b . Pinnule of 8 magnified	98
FIG.	2. ASPIDIUM CYSTOPTEROIDES, sp. nov.	99
	2. Portion of an ultimate pinna	99
	2 ^a . Pinnule of 2 magnified, to show sori and nervation	99
FIGS.	4, 5. POLYPODIUM FADYENIODES, sp. nov.	104
	4. Portion of a pinnule slightly enlarged, showing the under side	104
	4 ^a . A sorus of 4 magnified	104
	5. Portion of a pinnule of small size, not enlarged, showing the upper side	104
FIG.	6. ASPLENIOPTERIS ADIANTIFOLIA, sp. nov.	118
	6. Portion of frond, natural size, showing sori	118
	6 ^a . An ultimate pinna enlarged, to show sori	118
FIG.	7. ACROSTICHUM CRASSIFOLIUM, sp. nov.	105
	7. Fragment of a pinnule	105
	7 ^a . Fragment 7 magnified	105
FIG.	9. ASPIDIUM FREDERICKSBURGENSE, sp. nov.	94
	9. Fragment of an ultimate pinna with large sori	94

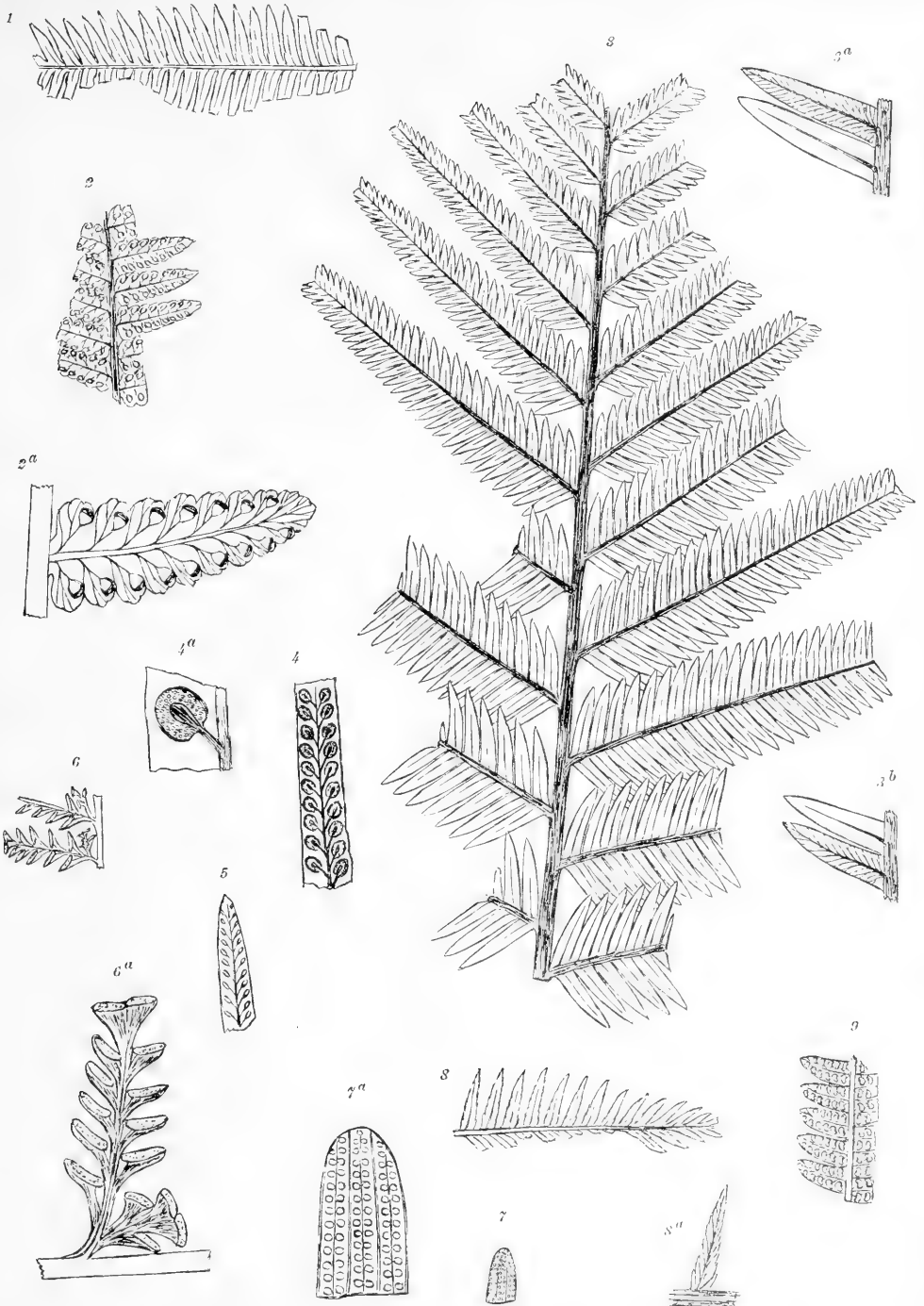

PLATE XVII.

PLATE XVII.

		Page.
FIG.	1. <i>ASPIDIUM ANGUSTIPINNATUM</i> , sp. nov	98
	1. Parts of a large fructified compound pinna or of the frond.....	98
	1 ^a . Pinnule of 1 magnified, to show sori and nerves.....	98
FIG.	2. <i>ASPIDIUM MACROCARPUM</i> , sp. nov	103
	2. Portion of a compound pinna, or of the frond, showing only sori and some of the nervs, owing to maceration	103
	2 ^a . Pinnule magnified.....	103
	2 ^b . Sorus still more magnified	103
FIGS. 3-7.	<i>THINNFELDIA VARIABILIS</i> , sp. nov	110
	3. Upper part of a compound pinna.....	110
	3 ^a . Portion of a pinnule magnified.....	110
	4. Portions of several ultimate pinnae.....	110
	4 ^a . Pinnule of 4 magnified to show nervation	110
	5. Ultimate pinna from the upper part of the frond	110
	6. Summit of an ultimate pinna	110
	7. Portion of an ultimate pinna with broad-toothed pinnules	110

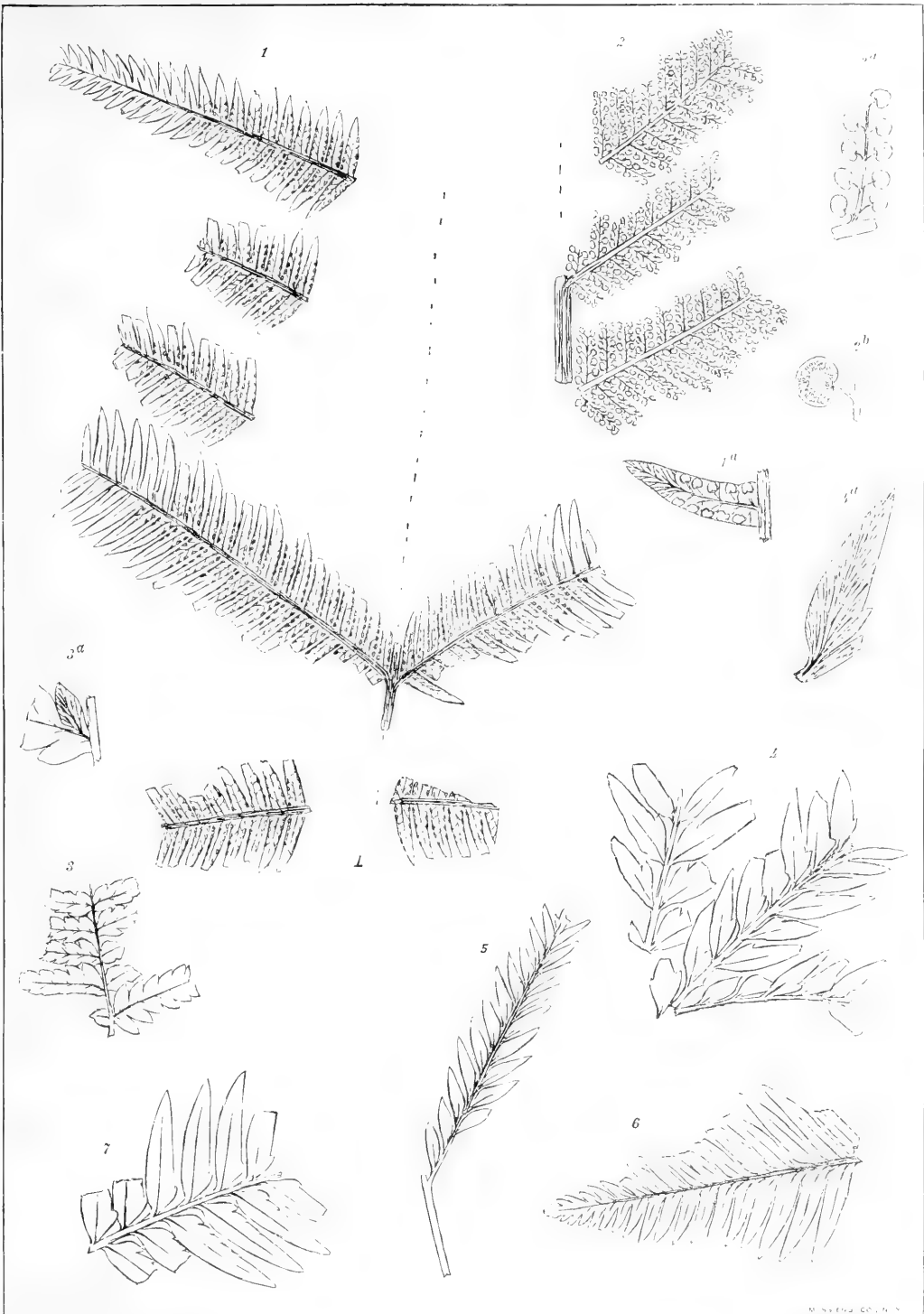

PLATE XVIII.

PLATE XVIII.

	Page.
FIGS. 1-6. <i>THINNFELDIA VARIABILIS</i> , sp. nov.	110
1. Two compound pinnae	110
1 ^a . Portion of a lower pinna magnified	110
1 ^b . Portion of an upper pinna magnified	110
1 ^c . Tip of a pinna magnified	110
2. Upper part of a compound pinna	110
2 ^a . Pinna of 2 magnified	110
3. Portions of two ultimate pinnae	110
3 ^a . Pinna of 3 magnified	110
4. Portion of the upper part of a primary compound pinna or of the frond	110
4 ^a . Portion of the same magnified to show nervation	110
5. Upper part of an ultimate pinna	110
6. Tip of a pinna from road-side near Potomac Run	110

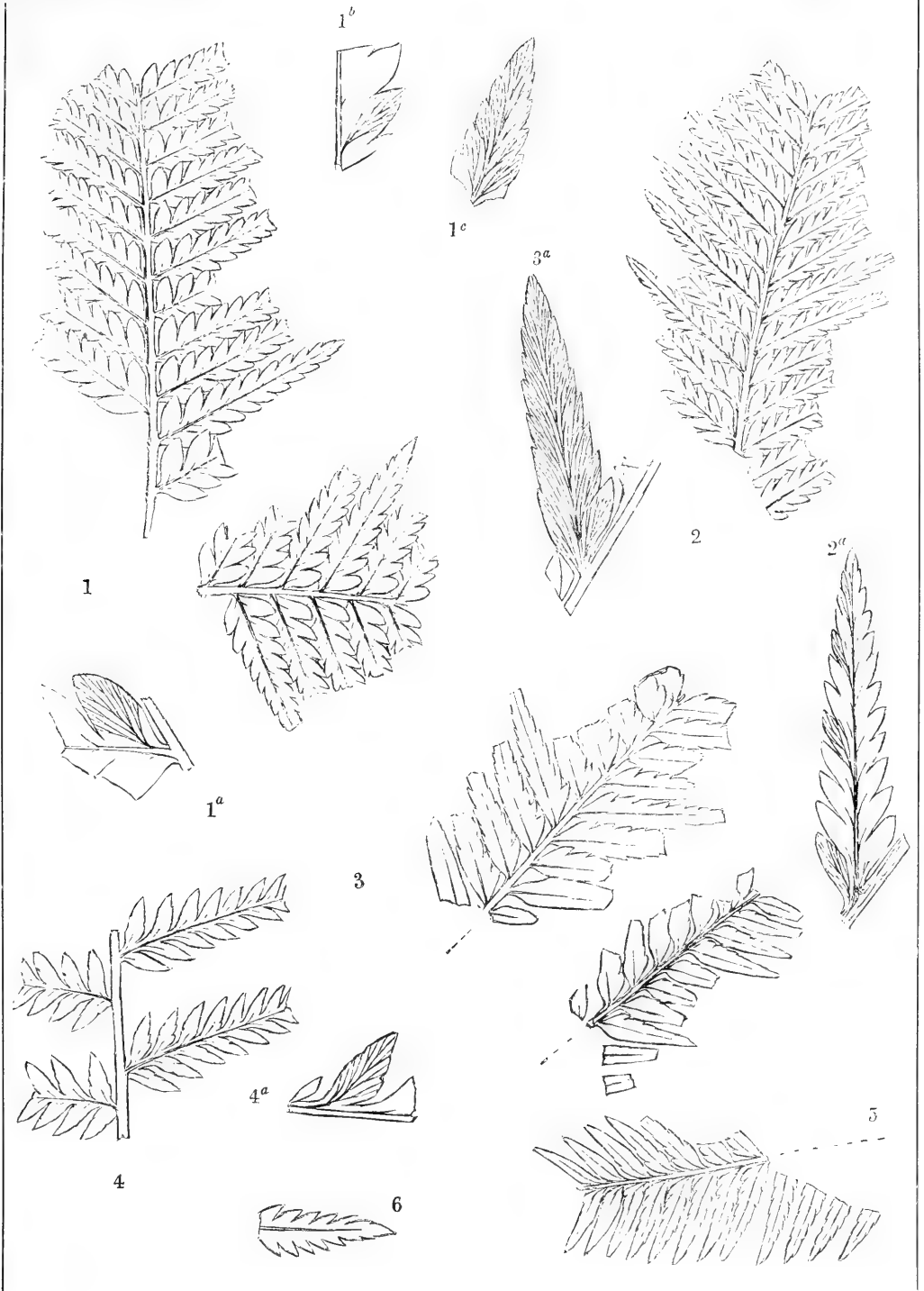

PLATE XIX.

PLATE XIX.

		Page.
FIG.	1. CLADOPHLEBIS CRENATA, sp. nov.	75
	1. Portion of an ultimate pinna.....	75
	1 ^a . Pinnule of 1 magnified.....	75
FIG.	2. CLADOPHLEBIS, sp. ?	78
	2. Several detached pinnules	78
	2 ^a . Portion of a pinnule magnified.....	78
FIG.	3. CLADOPHLEBIS, sp. ?	77
	3. Portion of an ultimate pinna.....	77
	3 ^a . Pinnule of 3 magnified.....	77
FIG.	4. ASPIDIUM OERSTEDI ? Heer	99
	4. End of a pinnule	99
	4 ^a . Fig. 4 magnified	99
FIG.	5. CLADOPHLEBIS ALATA, sp. nov.	77
	5. Portion of a compound pinna or of the frond	77
	5 ^a . Portion of a pinnule enlarged.....	77
FIGS.	6, 7. ASPIDIUM FREDERICKSBURGENSE, sp. nov.	94
	6, 7. Portions of compound pinnae from different parts of the plant	94
	6 ^a , 7 ^a . Magnified pinnules of 6, 7	94
FIG.	8. PECOPTERIS MICRODONTA, sp. nov.	85
	8. Portion of a compound pinna or of the frond.....	85
	8 ^a . Pinnule of 8 magnified.....	85
FIG.	9. PECOPTERIS STRICTINERVIS, sp. nov.	84
	9. Portion of a compound pinna	84
	9 ^a . Magnified pinnule of 9	84
FIG.	10. ASPIDIUM ANGUSTIPINNATUM, sp. nov.	98
	10. Portion of an ultimate pinna.....	98

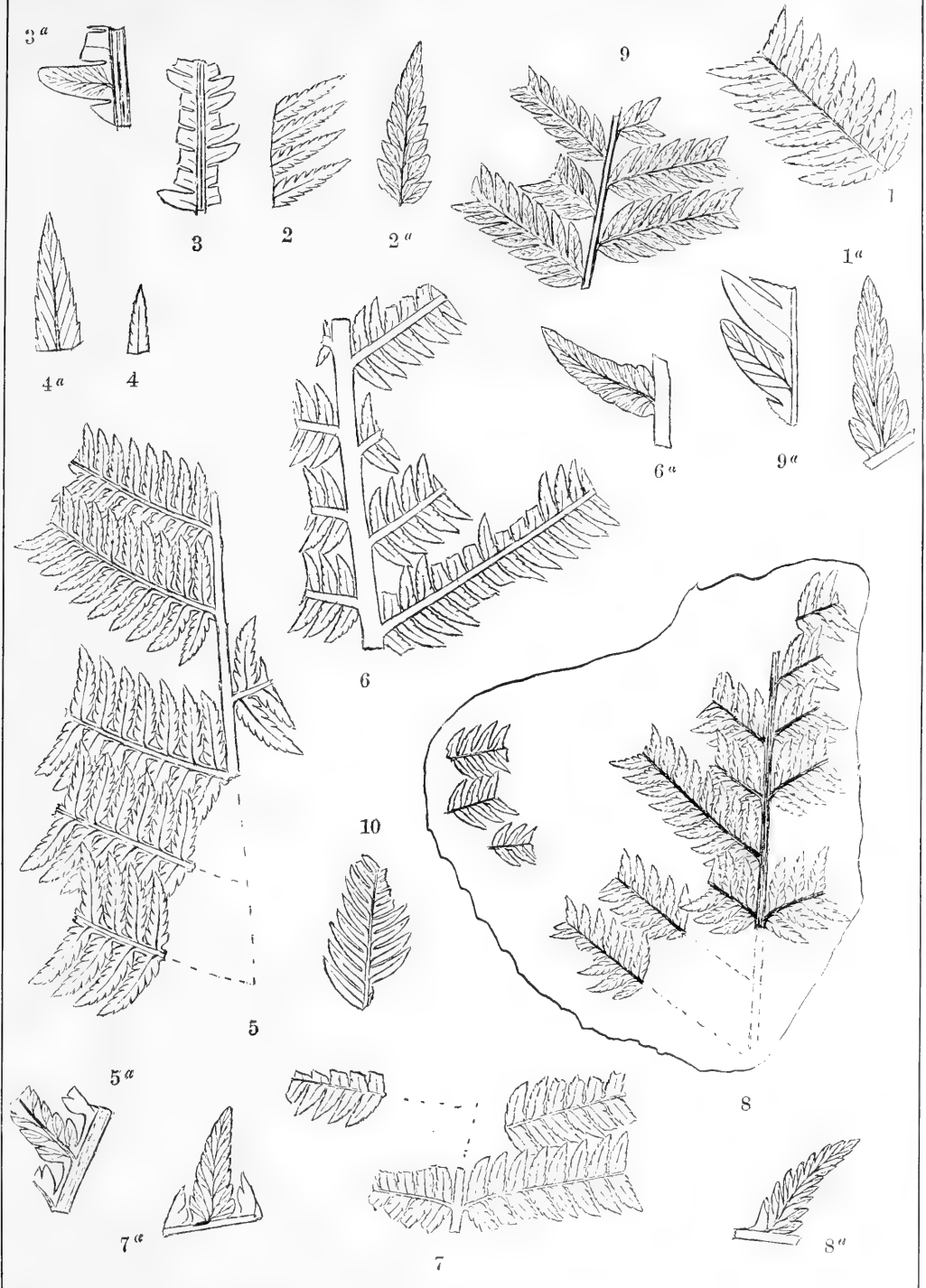

PLATE XX.

MON XV—27

PLATE XX.

	Page.
FIGS. 1, 2, 4. <i>PECOPTERIS CONSTRICTA</i> , sp. nov.	86
1. Portion of a primary pinna from probably the middle part of the frond.....	86
1 ^a . Part of a pinna of 1 magnified, to show nervation	86
2. Portion of a compound pinna from probably the middle part of a frond.....	86
4. Portion of probably an ultimate pinna from the lower part of the frond.....	86
4 ^a . Portion of a pinnule magnified.	86
4 ^b . Tip of a pinnule magnified.	86
FIG. 3. <i>PECOPTERIS STRICTINERVIS</i> , sp. nov.	84
3. Several detached ultimate pinnae	84
3 ^a . Pinnule of 3 magnified.....	84
FIGS. 5, 11. <i>PECOPTERIS MICRODONTA</i> , sp. nov.	85
5. Small fragment of an ultimate pinna.....	85
11. Two detached ultimate pinnæ.....	85
11 ^a . Pinnule of 11 magnified.....	85
FIG. 6. <i>CLADOPHLEBIS CRENATA</i> , sp. nov.	75
6. Portion of a compound pinna	75
6 ^a . Pinnule magnified.....	75
FIG. 7. <i>CLADOPHLEBIS</i> , sp. ?.....	76
7. Portion of an ultimate pinna.....	76
7 ^a . Pinnule magnified.....	76
FIG. 8. <i>CLADOPHLEBIS INCLINATA</i> , sp. nov.	76
8. Small fragment of an ultimate pinna.....	76
8 ^a . Pinnules of 8 magnified.....	76
FIGS. 9, 10. <i>CLADOPHLEBIS ROTUNDATA</i> , sp. nov.	78
9. Part of a primary pinna or of the frond.....	78
9 ^a . Pinnules of 9 magnified.....	78
9 ^b . Tip of a pinna magnified	78
10. Portion of an ultimate pinna from the lower part of the frond	78
10 ^a . Pinnule of 10 magnified.....	78

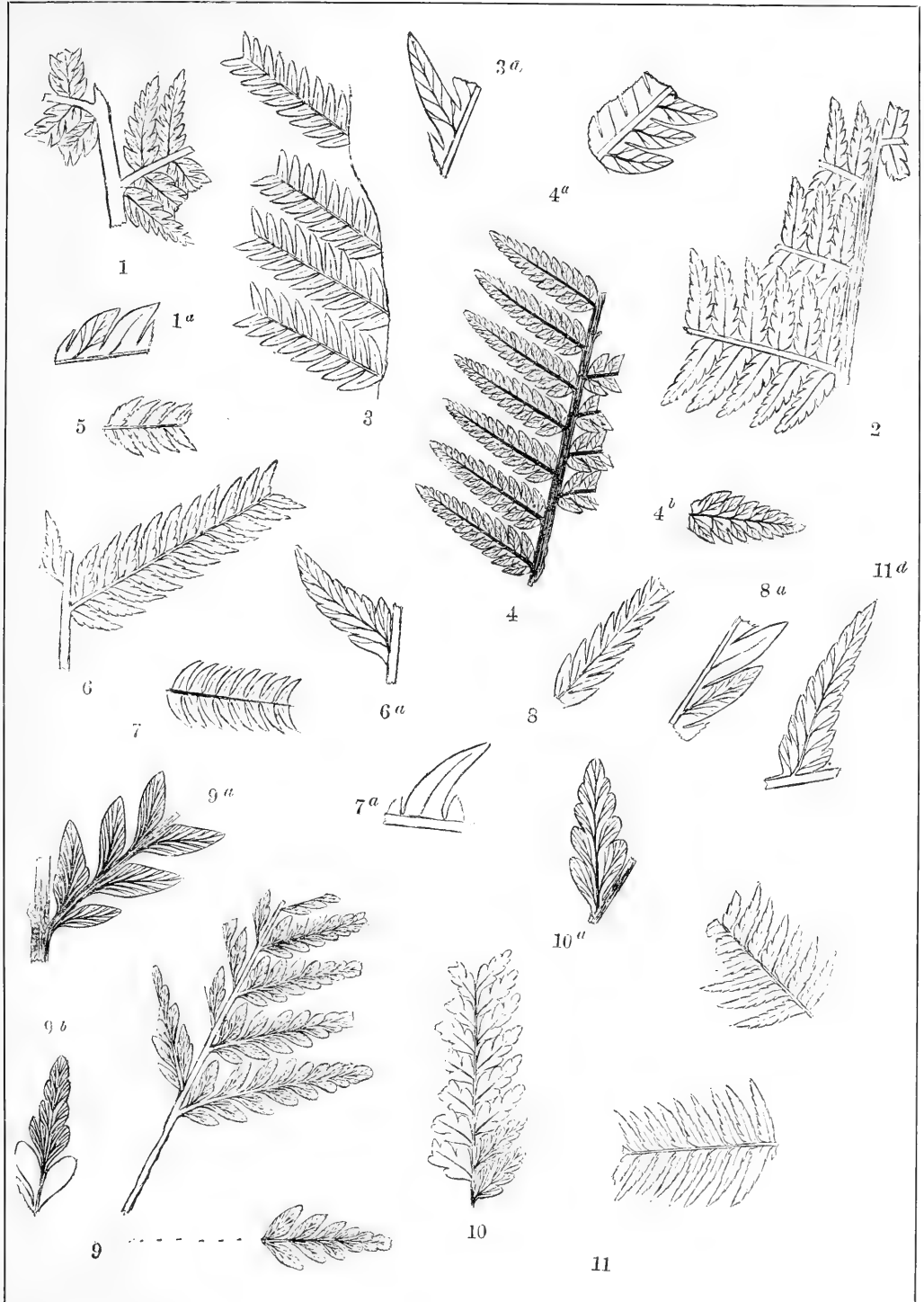

PLATE XXI.

PLATE XXI.

	Page.
FIGS. 1-3. <i>PECOPTERIS BREVIPENNIS</i> , sp. nov.	86
1, 2, 3. Portions of ultimate pinnae	86
1. Portion of ultimate pinna differing in facies somewhat from 2 and 3	86
1 ^a . Part of a pinna of 1 magnified	86
2 ^a . Two pinnules of 2 magnified	86
3 ^a . Portion of a pinnule of 3 magnified	86
FIG. 4. <i>CLADOPHLEBIS SPIENOPTEROIDES</i> , sp. nov.	79
4. Summit of an ultimate pinna	79
4 ^a . Pinnule of 4 magnified	79
FIG. 5. <i>ASPIDIUM OBLONGIFOLIUM</i> , sp. nov.	100
5. Two detached pinnules	100
FIG. 6. <i>ASPIDIUM PARVIFOLIUM</i> , sp. nov.	100
6. Fragment of an ultimate pinna	100
6 ^a . Pinnule of 6 magnified, to show nerves and sori	100
6 ^b . Sorus much magnified	100
FIG. 7. <i>PECOPTERIS SOCIALIS</i> , Heer.	87
7. Several detached ultimate pinnae	87
FIG. 8. <i>STENOPTERIS VIRGINICA</i> , sp. nov.	112
8. Several fragments from the upper part of the plant	112
FIGS. 9, 13. <i>CLADOPHLEBIS CONSTRICTA</i> ? sp. nov.	68
5, 9, 13. Small fragments from Deep Bottom of what is probably <i>C. constricta</i>	68
FIG. 10. <i>PECOPTERIS ANGUSTIPENNIS</i> , sp. nov.	87
10. A portion of a pinnule	87
10 ^a . Lower portion of 10 magnified	87
FIG. 11. <i>GLEICHENIA NORDENSKIÖLDI</i> ? Heer.	119
11. Fragment of a pinna	119
11 ^a . Pinnules magnified	119
FIG. 12. Undetermined fern	119
FIG. 14. <i>ASPIDIUM VIRGINICUM</i> , sp. nov.	97
14. Fragment of a compound pinna	97
14 ^a . Pinnule of 14 magnified	97
14 ^b . Portion of 14 ^a still more magnified, to show sori	97
FIG. 15. <i>ASPIDIUM PINNATIFIDUM</i> , sp. nov.	101
15. Fragment of an ultimate pinna	101
15 ^a . Pinnule of 15 magnified	101

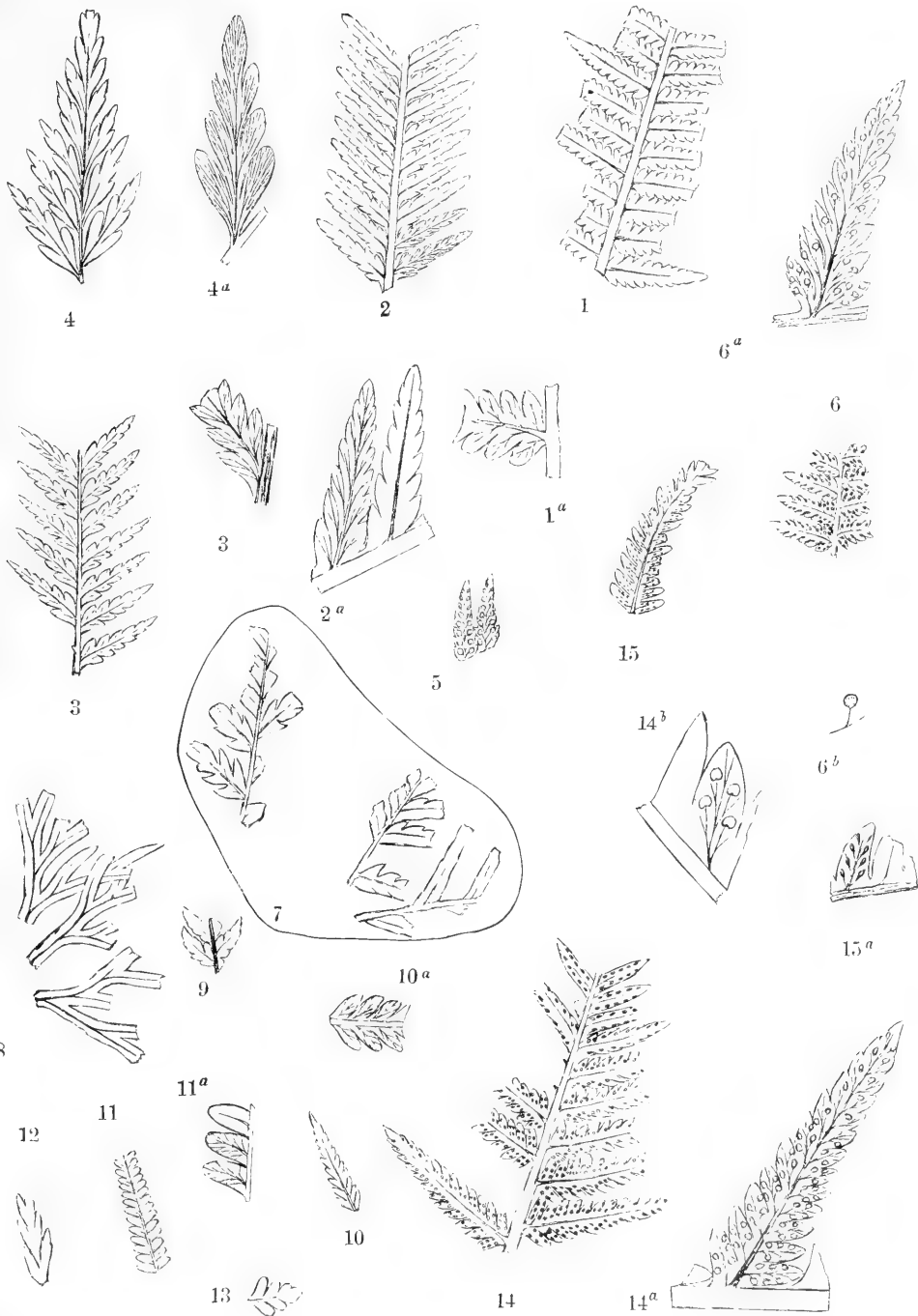

PLATE XXII.

PLATE XXII.

		Page.
FIGS. 1-3, 6, 7.	ASPLENIOPTERIS PINNATIFIDA, sp. nov.	118
	1. Portion of a sterile compound pinna from the upper part of the plant.....	118
	1 ^a . Pinnule of 1 magnified.....	118
	2. Portion of a compound pinna from the lower part of the frond.....	118
	2 ^a . Portion of a pinna magnified.....	118
	3. Fragment of a pinnule.....	118
	6. Portion of a fertile compound pinna slightly restored.....	118
	6 ^a . Sori of 6 enlarged.....	118
	6 ^b . Portion from near the tip of the pinnule enlarged, to show the nerves.....	118
	7. Fragment of a pinnule partly fructified.....	118
FIGS.	4, 5. POLYPODIUM DENTATUM, sp. nov.	105
	4. Fragment of a fertile pinna.....	105
	4 ^a . Portion of 4 magnified.....	105
	5. Portions of two sterile pinnae.....	105
	5 ^a . Pinnules of 5 magnified.....	105
FIG.	8. CLADOPHLEBIS PETIOLATA, sp. nov.	80
	8. Fragment of an ultimate pinna.....	80
	8 ^a . Pinnule enlarged.....	80
FIG.	9. ASPIDIUM DUNKERI Schimper, sp.	101
	9. Portion of a fertile frond.....	101
	9 ^a . Magnified pinnule, showing the lower side.....	101
	9 ^b . Magnified pinnule, showing the upper side.....	101
FIGS.	10, 11. PECOPTERIS BROWNIANA Dunker.....	88
	10. Fragment of compound pinna from Fredericksburg.....	88
	11. Fragment of a compound pinna collected by Meek at Baltimore.....	88
	11 ^a . Pinnule of 11 magnified.....	88
FIG.	12. PECOPTERIS OVATODENTATA, sp. nov.	85
	12. Small fragment of an ultimate pinna.....	85
	12 ^a . Pinnule of 12 magnified, to show nervation.....	85
FIG.	13. PECOPTERIS STRICTINERVIS, sp. nov.	84
	13. End of an ultimate pinna.....	84
	13 ^a . Pinnules of 13 magnified.....	84

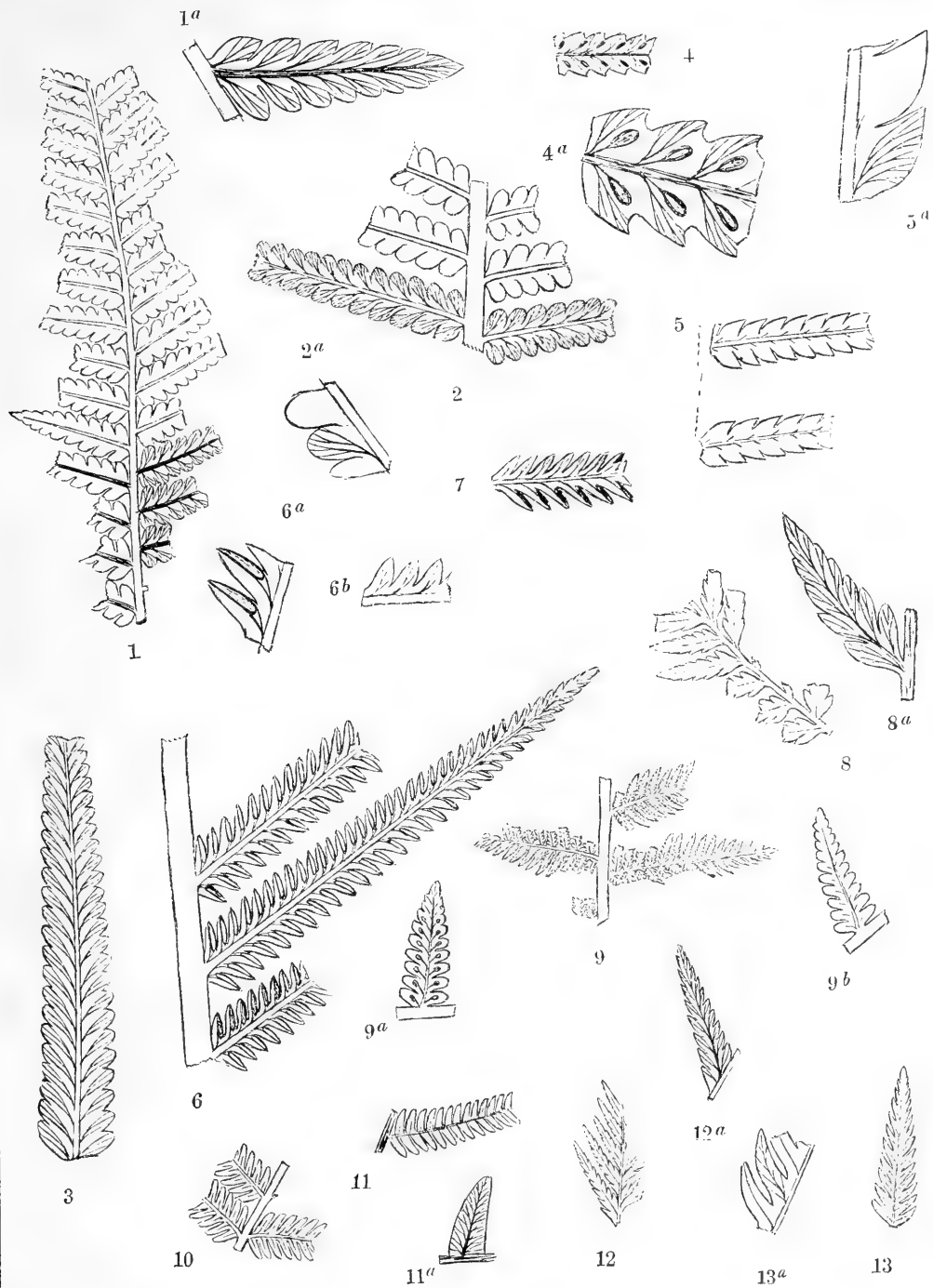

PLATE XXIII.

PLATE XXIII.

	Page.
FIG. 1. <i>PECOPTERIS OVATODENTATA</i> , sp. nov.	85
1. Several detached ultimate pinnae	85
1 ^a . Magnified pinnule of 1, showing nervation	85
FIGS. 2-7. <i>PECOPTERIS BROWNIANA</i> , Dunker	88
2. Summit of a compound pinna slightly restored	88
2 ^a . Pinnule of 2 magnified	88
3. Portion of the upper part of the frond	88
3 ^a . Lower pinnule magnified	88
3 ^b . Upper pinnule magnified	88
3 ^c . Pinnules from the extremity of the pinna magnified	88
4. Portion of a compound pinna slightly restored	88
4 ^a . Pinnules from the lower part of 4 magnified	88
4 ^b . Pinnules from the central part of 4 magnified	88
5. Upper part of a compound pinna	88
5 ^a . Pinnule or pinna magnified	88
6. Portions of two detached compound pinnae	88
6 ^a . Lower pinnule magnified	88
7. Small fragment of the upper part of a compound pinna	88
7 ^a . Pinnule magnified	88

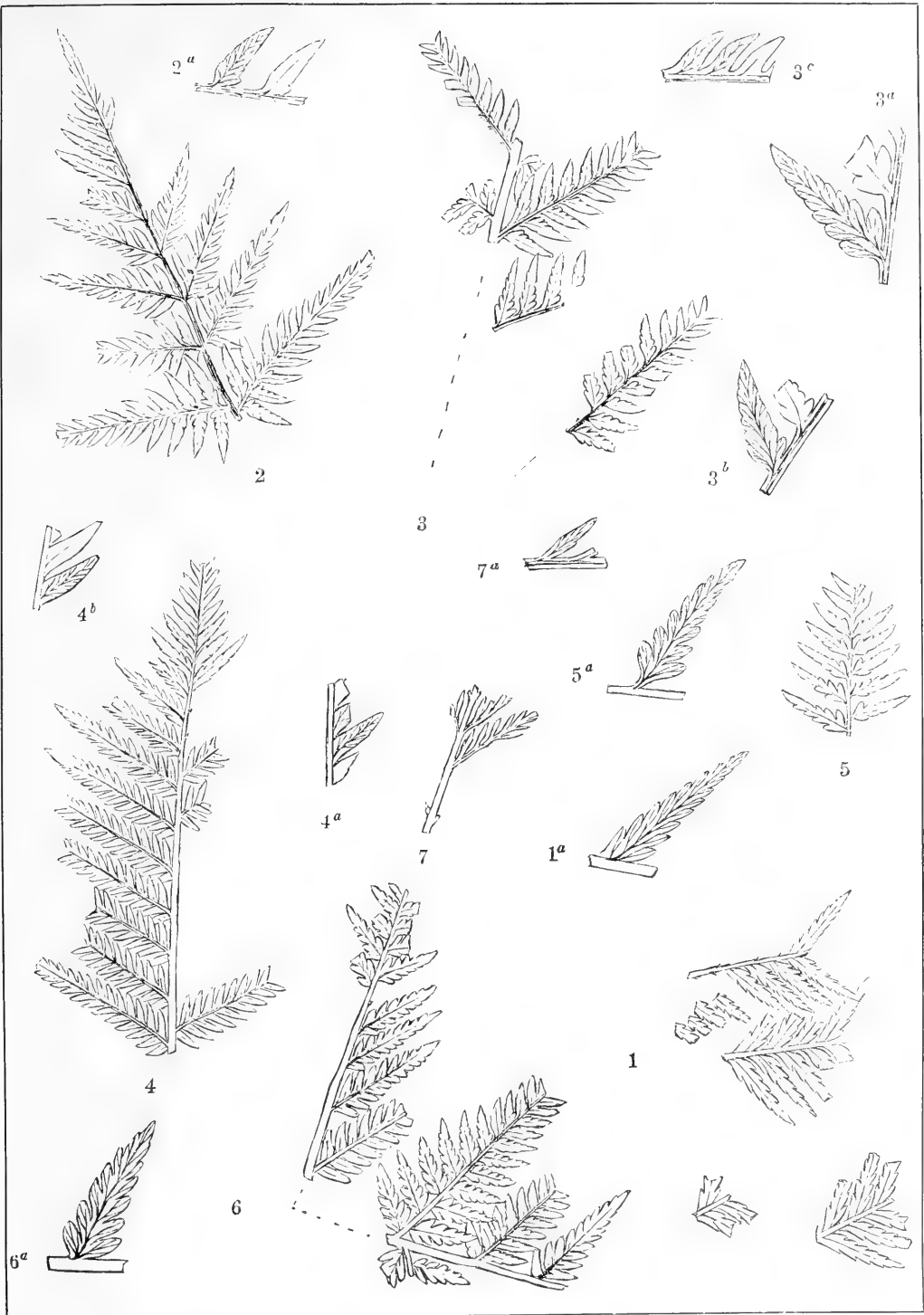

PLATE XXIV.

PLATE XXIV.

		Page.	
FIG.	1. <i>THYRSOPTERIS VIRGINICA</i> , sp. nov.	120	
	1. Fragment of an ultimate pinna.	120	
	1 ^a . Fragment 1 magnified.	120	
FIG.	2. <i>PECOPTERIS VIRGINIENSIS</i> , sp. nov.	82	
	2. Fragment of an ultimate pinna.	82	
	2 ^a . Portion of a pinnule magnified, to show nervation.	82	
FIG.	3. <i>THYRSOPTERIS ELLIPTICA</i> , sp. nov.	133	
	3. Portion of a compound pinna.	133	
	3 ^a . Pinnule of 3 magnified.	133	
FIGS. 4, 6, 7, 9.	<i>THYRSOPTERIS DENTATA</i> , sp. nov.	121	
	4. Portion of the summit of a compound pinna.	121	
	6. Portion of the lower part of a compound pinna.	121	
	6 ^a . Lower pinnule magnified.	121	
	6 ^b . Upper pinnule magnified.	121	
	7. Tip of an ultimate pinna.	121	
	7 ^a . Pinnule magnified.	121	
	9. Portions of several detached ultimate pinnae.	121	
	9 ^a . Lower pinnule magnified.	121	
	9 ^b . Upper pinnule magnified.	121	
FIGS.	5, 10. <i>THYRSOPTERIS BREVIFOLIA</i> , sp. nov.	121	
	5. Portion of a compound pinna slightly restored.	121	
	5 ^a -5 ^d . Pinnules magnified.	121	
	5 ^a . From the lower part of the frond.	121	
	5 ^b . From the middle.	121	
	5 ^c . From the upper part.	121	
	5 ^d . Terminal pinnules of a pinna.	121	
	10. Tip of an ultimate pinna.	121	
	FIG.	8. <i>ASPIDIUM PARVIFOLIUM</i> , sp. nov.	100
		8. Portion of a compound pinna from the upper part of the frond.	100
8 ^a . Pinnule magnified.		100	

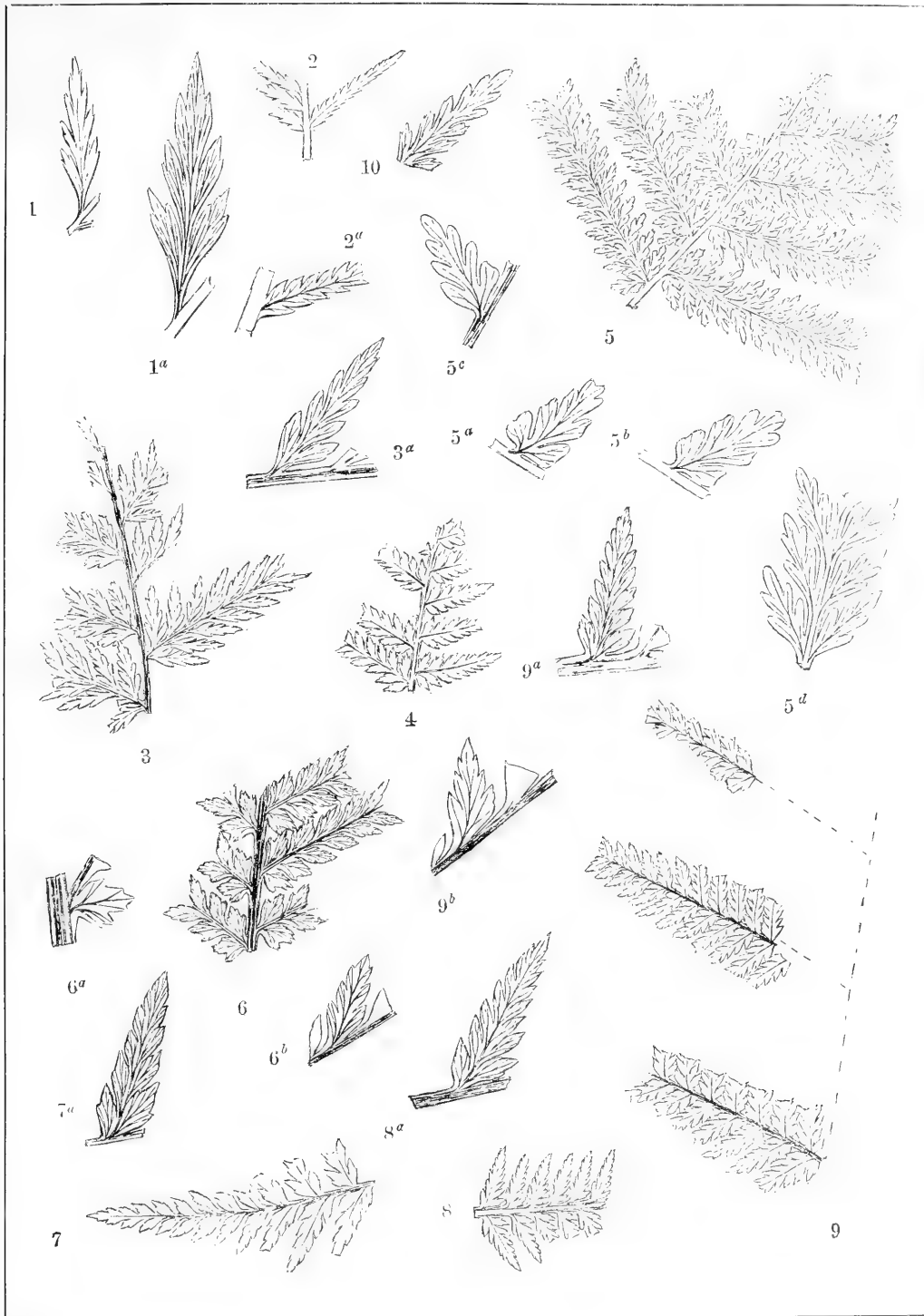

PLATE XXV.

PLATE XXV.

	Page.
FIGS. 1-2. <i>THYRSOPTERIS DENTATA</i> , sp. nov.	121
1. Portion of the upper part of a compound pinna.	121
1 ^a . Pinna of 1 magnified.	121
2. Portion of an ultimate compound pinna.	121
2 ^a . Pinnule of 2 magnified.	121
FIG. 3. <i>SPHENOPTERIS THYRSOPTEROIDES</i> , sp. nov.	89
3. Portion of the upper part of a compound pinna.	89
3 ^a . Portion of a pinna magnified.	89
FIGS. 4, 5, 16. <i>THYRSOPTERIS NERVOSA</i> , sp. nov.	122
4, 5. Tips of ultimate pinnae.	122
4 ^a . Magnified pinnule of 4.	122
16. Summit of an ultimate pinna.	122
FIGS. 6, 7, 14, 15. <i>ASPIDIUM DENTATUM</i> , sp. nov.	102
6, 7. Portions of ultimate pinnae high up in the frond.	102
6 ^a , 7 ^a . Pinnules of 6, 7 magnified.	102
14. Portion of a fertile compound pinna.	102
14 ^a . Pinnules of 14 magnified.	102
15. Upper part of a compound pinna.	102
15 ^a . Upper pinnules of 15 magnified.	102
FIG. 8. <i>CLADOPHEBIS INAEQUILOBA</i> , sp. nov.	80
8. Portion of the upper part of a compound pinna.	80
FIG. 9. <i>CLADOPHEBIS PACHYPHYLLA</i> , sp. nov.	80
9. Upper part of an ultimate pinna.	80
9 ^a . Pinnules of 9 magnified.	80
FIG. 10. <i>ASPIDIUM PARVIFOLIUM</i> , sp. nov.	100
10. Fragment of a compound pinna.	100
FIGS. 11, 12. <i>ASPIDIUM DUNKERI</i> Schimper, sp.	101
11, 12. Fragments of ultimate pinnae.	101
11 ^a . Pinnule of 11 magnified.	101
FIG. 13. <i>OSMUNDA SPHENOPTEROIDES</i> , sp. nov.	145
13. Two detached ultimate pinnae.	145
13 ^a . Sterile pinnule magnified.	145
13 ^b . Fertile pinnule magnified.	145



PLATE XXVI.

PLATE XXVI.

		Page.
FIGS. 1, 14, 16, 17.	ASPIDIUM PARVIFOLIUM, sp. nov.	100
	1. Small fragment of an ultimate pinna	100
	1 ^a . Pinnule of 1 magnified	100
14, 16, 17.	Fragments of ultimate pinnae from the upper part of the frond	100
	16 ^a . Pinnule of 16 magnified	100
FIGS. 2, 8, 9, 18.	ASPIDIUM DUNKERI Schimper, sp.	101
	2. Fragment of an ultimate pinna	101
	2 ^a . Pinnules of 2 magnified	101
	8. Portion of a compound pinna or of the frond	101
	8 ^a . Pinnule of 8 magnified	101
	9. Fragment of an ultimate pinna	101
	9 ^a . Pinnule magnified	101
	18. Portion of an ultimate pinna	101
	18 ^a . Pinnule magnified	101
FIGS. 3, 13.	PECOPTERIS BROWNIANA Dunker	88
	3. Upper part of a compound pinna	88
	3 ^a . Pinnules magnified	88
	13. Portion of a compound pinna	88
	13 ^a . Pinnule magnified	88
FIGS. 4, 5.	PECOPTERIS PACHYPHYLLA, sp. nov.	88
	4. Fragment of a compound pinna	88
	4 ^a . Pinna magnified	88
	5. Portion of a lower compound pinna	88
	5 ^a . Part of a pinna magnified	88
FIGS. 6, 7.	THYRSOPTERIS RARINERVIS, sp. nov.	123
	6. Fragment of a compound pinna	123
	7. Fragment of the upper part of an ultimate pinna	123
	7 ^a . Pinnule of 7 magnified	123
FIGS. 10-12.	THINNFELDIA GRANULATA, sp. nov.	111
10-12.	Portions of the upper part of ultimate pinnae, variously lobed	111
FIG. 15.	CLADOPHLEBIS, sp. undetermined	81
	15. Small fragment of an ultimate pinna	81

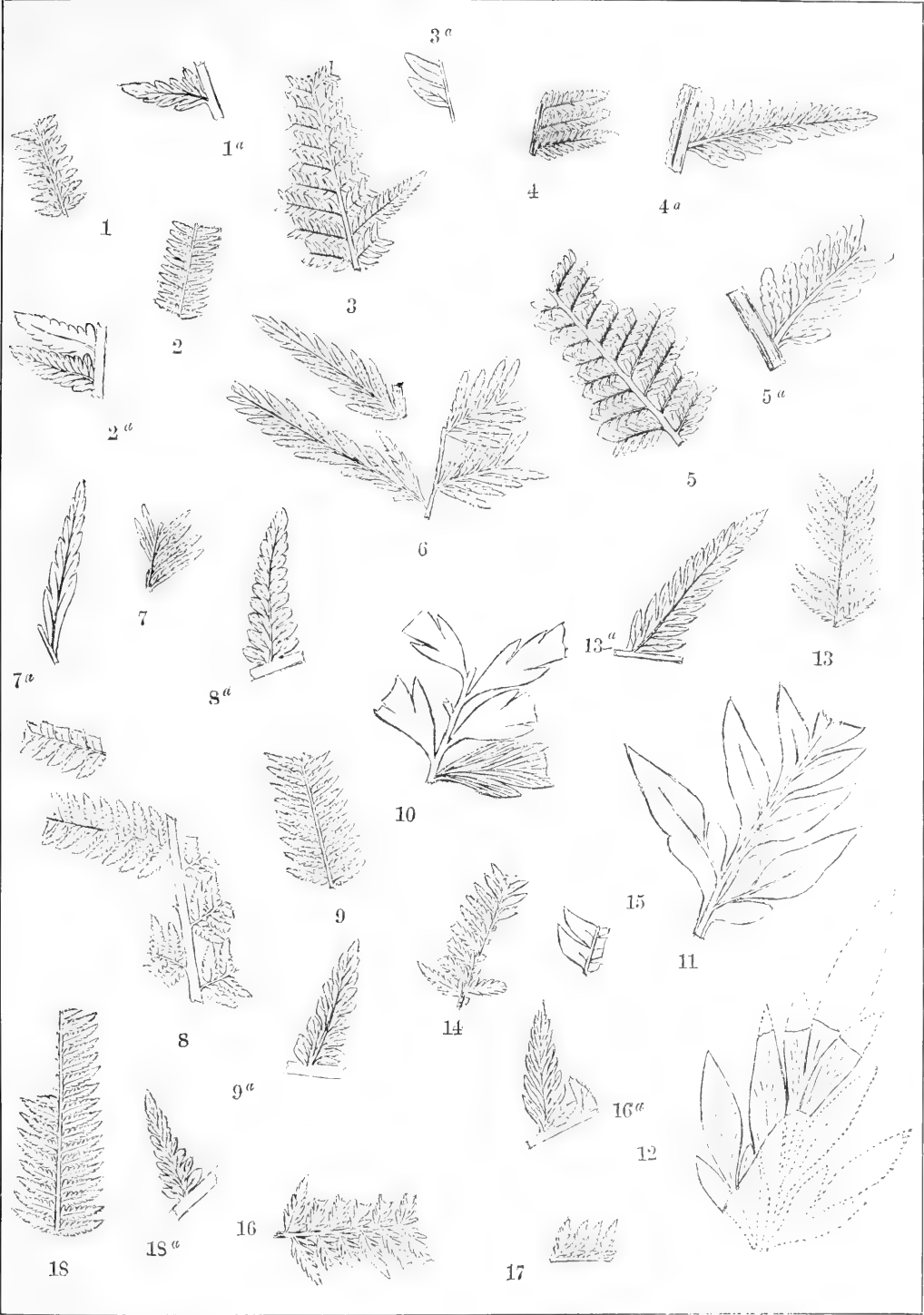

PLATE XXVII.

PLATE XXVII.

	Page.
FIGS. 1-5, 8. THINNFELDIA GRANULATA, sp. nov.	111
1. Upper portion of a compound pinna	111
2. Termination of a pinnule or pinna	111
3. Pinnule showing incipient lobing	111
4. Terminal portion of a compound pinna	111
5. Upper part of a compound pinna	111
5 ^a . Pinnule magnified	111
5 ^b . Portion of 5 much magnified, and showing the fine granulation	111
8. Tip of a pinnule or pinna	111
FIGS. 6, 7. THINNFELDIA ROTUNDILOBA, sp. nov.	111
6. Summit of a compound pinna	111
7. Portion of a compound pinna	111
7 ^a . Pinnule magnified	111
FIG. 10. SAGENOPTERIS LATIFOLIA, sp. nov.	148
10. Portion of a leaf	148
FIGS. 9, 11-17. SAGENOPTERIS ELLIPTICA, sp. nov.	149
9. Fragment of a small leaf	149
11. Upper part of a leaf of medium size	149
12. Basal portion of a large leaf	149
13. Tip of a small leaf	149
14. Petiole, with leaflets once attached to it	149
15. Portion of a leaf showing the corpuscles on the under side	149
15 ^a . Portion of 15 magnified	149
16. Upper part of a leaf of medium size	149
16 ^a . Part of 16 magnified	149
17. Fragment of a leaf slightly enlarged, to show nervation	149

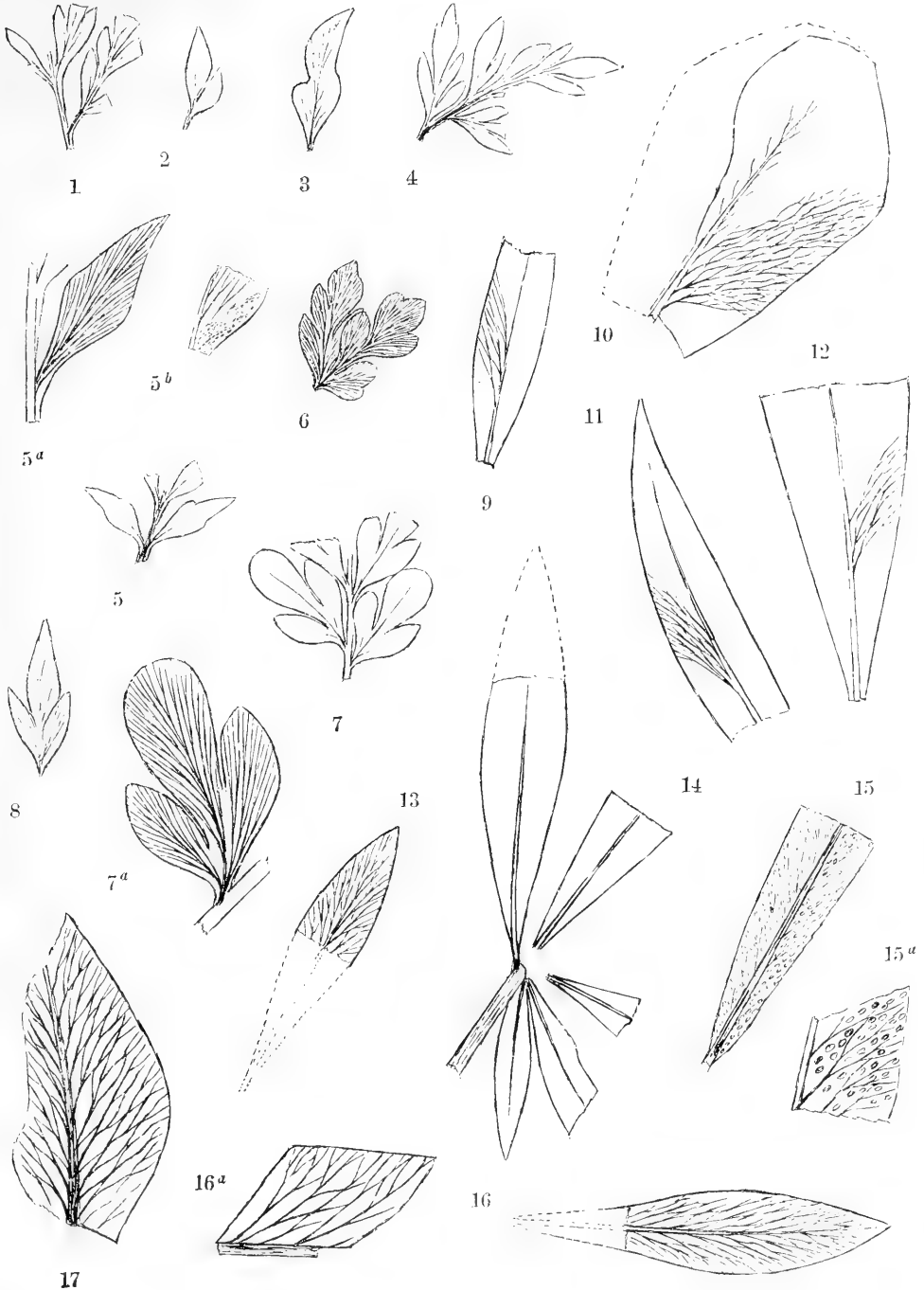

PLATE XXVIII.

MON XV—28

PLATE XXVIII.

	Page.
FIG. 1. ANGIOPTERIDIUM AURICULATUM, sp. nov	113
1. Portion of the frond showing several pinnules	113
FIGS. 2, 4, 6. SCLEROPTERIS ELLIPTICA, sp. nov	151
2. Fragment showing remote and small pinnules	151
2 ^a . Pinnule of 2 magnified.....	151
4. Terminal portion of a pinna with small pinnules	151
6. Large fragment of a primary pinna or of the frond	151
FIGS. 3, 5. SCLEROPTERIS VIRGINICA, sp. nov.....	152
3. Upper part of a compound pinna or of the frond	152
3 ^a . Pinnule of 3 magnified	152
5. Summit of a compound pinna or of the frond, slightly restored	152
5 ^a . Tip of a pinna of 5 magnified.....	152
5 ^b . Pinnules of 5 magnified	152
FIG. 7. SCLEROPTERIS ELLIPTICA, var. LONGIFOLIA, sp. nov	152
7. Summit of an ultimate compound pinna	152

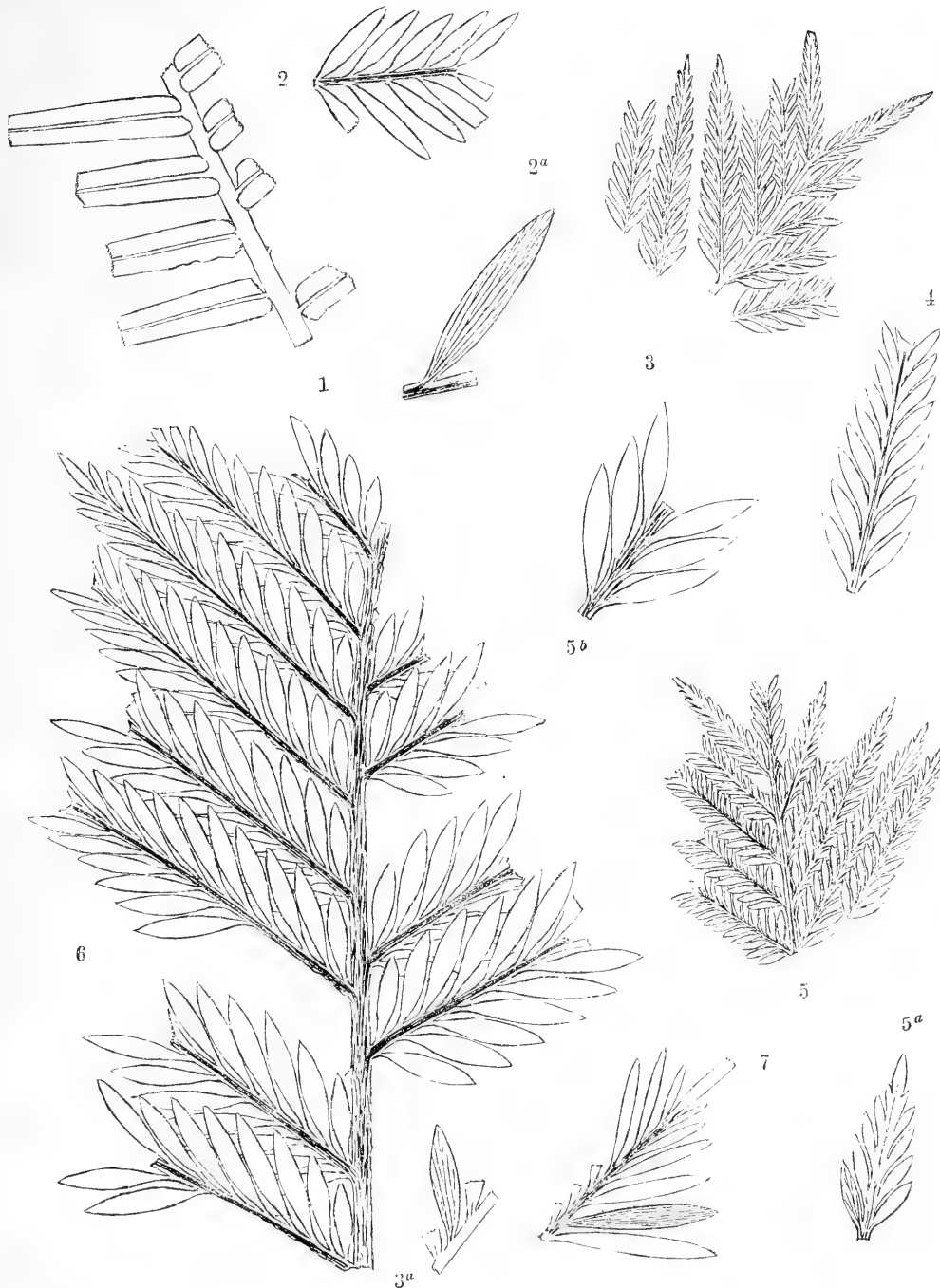

PLATE XXIX.

P L A T E X X I X .

	Page.
FIG. 1. <i>SCLEROPTERIS ELLIPTICA</i> , sp. nov.	151
1. Upper portion of a compound pinna or of the frond, slightly restored.	151
1 ^a . Pinnules magnified	151
FIG. 2. <i>ANGIOPTERIDIUM NERVOSUM</i> , sp. nov.	114
2. Fragment of a pinnule	114
2 ^a . Portion of 2 slightly magnified, showing typical nervation	114
FIG. 3. <i>ANGIOPTERIDIUM ELLIPTICUM</i> , sp. nov.	114
3. Entire detached pinnule	114
FIG. 4. <i>ANGIOPTERIDIUM DENSINERVE</i> , sp. nov.	115
4. Small fragment of a pinnule	115
4 ^a . Portion of 4 magnified	115
FIG. 5. <i>ANGIOPTERIDIUM PACHYPHYLLUM</i> , sp. nov.	115
5. Fragment of a pinnule	115
FIGS. 6, 7. <i>ANGIOPTERIDIUM OVATUM</i> , sp. nov.	115
6. Basal portion of a pinnule	115
7. Terminal portion of a pinnule	115
FIGS. 8, 9. <i>ANGIOPTERIDIUM STRICTINERVE</i> , sp. nov.	116
8. Portion of pinnule showing nerves	116
8 ^a . Portion of 8 enlarged	116
9. Portions of the frond with pinnules attached	116

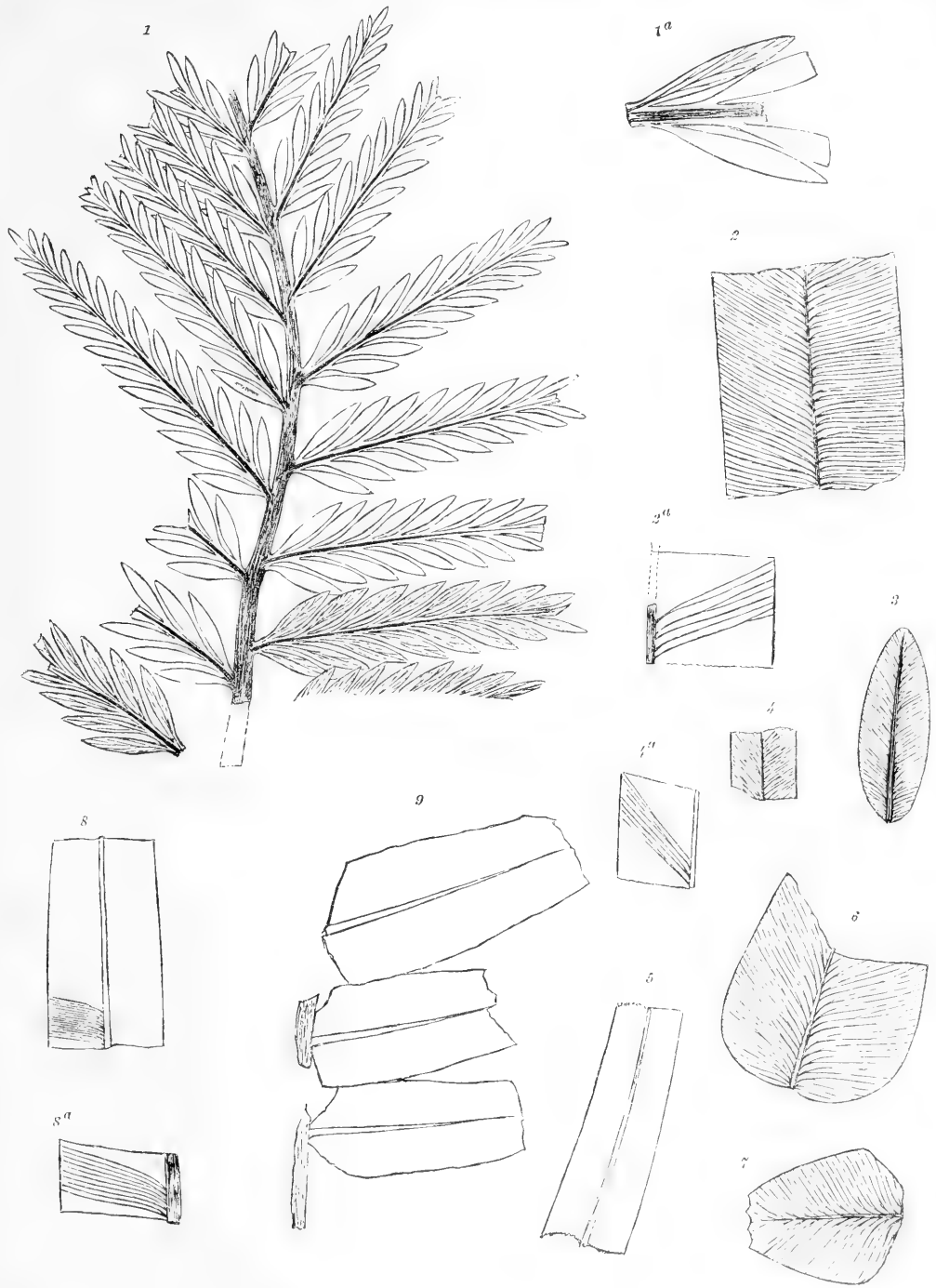
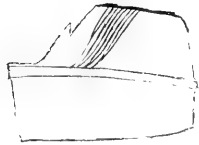

PLATE XXX.

P L A T E X X X .

	Page.
FIGS. 1, 5. ANGIOPTERIDIUM STRICTINERVE, var. LATIFOLIUM, sp. nov.	116
1. Two detached pinnules	116
5. Fragment of a larger pinnule	116
FIGS. 2, 3. ANOMOZAMITES ANGUSTIFOLIUS, sp. nov.	167
2. Tip of a leaf collected by Meek at Baltimore.	167
3. Fragment of the middle portion of a leaf.	167
FIG. 4. ANOMOZAMITES VIRGINICUS, sp. nov.	168
4. Fragment of a large leaf.	168
FIGS. 6, 7. ANGIOPTERIDIUM DENTATUM, sp. nov.	117
6. Fragments of several detached pinnules, arranged as if coming off from a common petiole	117
6 ^a , 6 ^b . Different forms of teeth magnified	117
6 ^c . Tip of a pinnule magnified to show the form of the teeth at the end of the pinnules.	117
7. A fragment of the end of a pinnule	117
FIG. 8. PLATYPTERIGIUM DENSINERVE, sp. nov.	169
8. Fragment of the lower part of a leaf seen with the under side uppermost	169



2



1

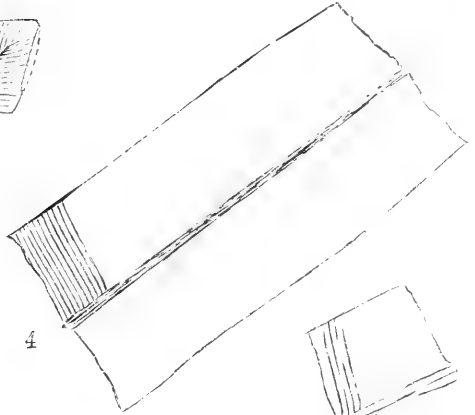

4



3

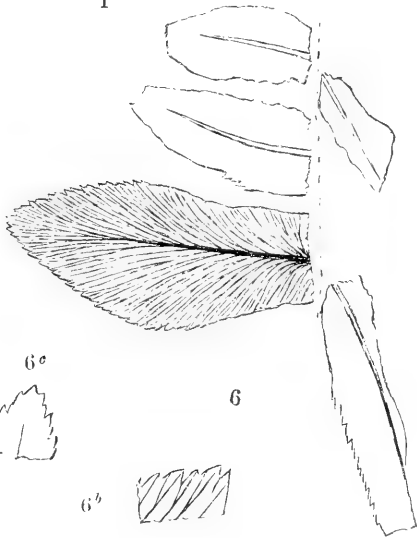

6



6^c



6^b



6^a

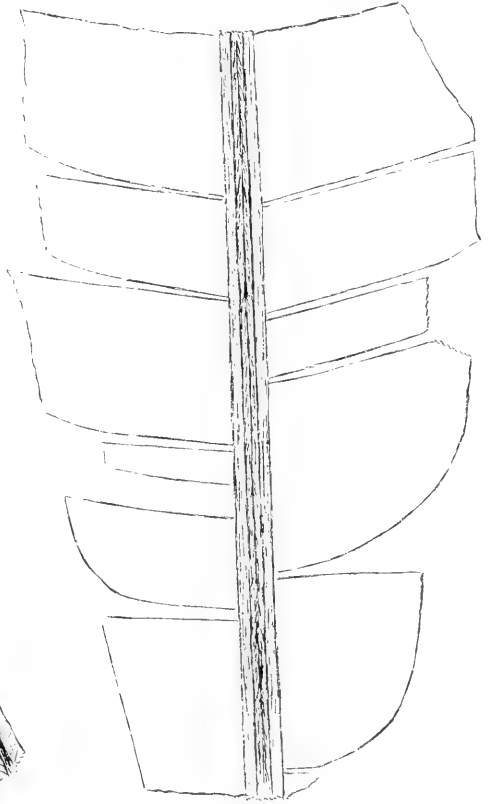

8

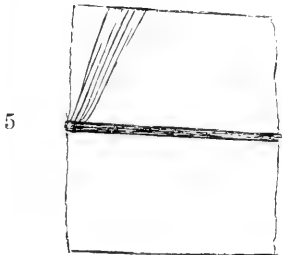

5



7

PLATE XXXI.

PLATE XXXI.

	Page.
FIGS. 1, 4. <i>PLATYPTERIGIUM DENSINERVE</i> , sp. nov.	169
1. Portion of the middle part of a large leaf seen with the upper surface uppermost ..	169
4. Portion of a petiole with the lower surface uppermost	169
FIG. 2. <i>PLATYPTERIGIUM ROGERSIANUM</i> , sp. nov.	171
2. Portion of the lower part of the leaf.	171
FIG. 3. <i>ANOMOZAMITES VIRGINICUS</i> , sp. nov.	168
3. Portion of a leaf.	168

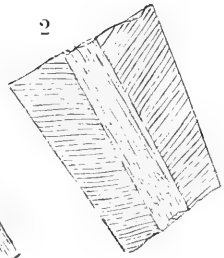
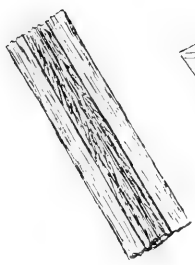
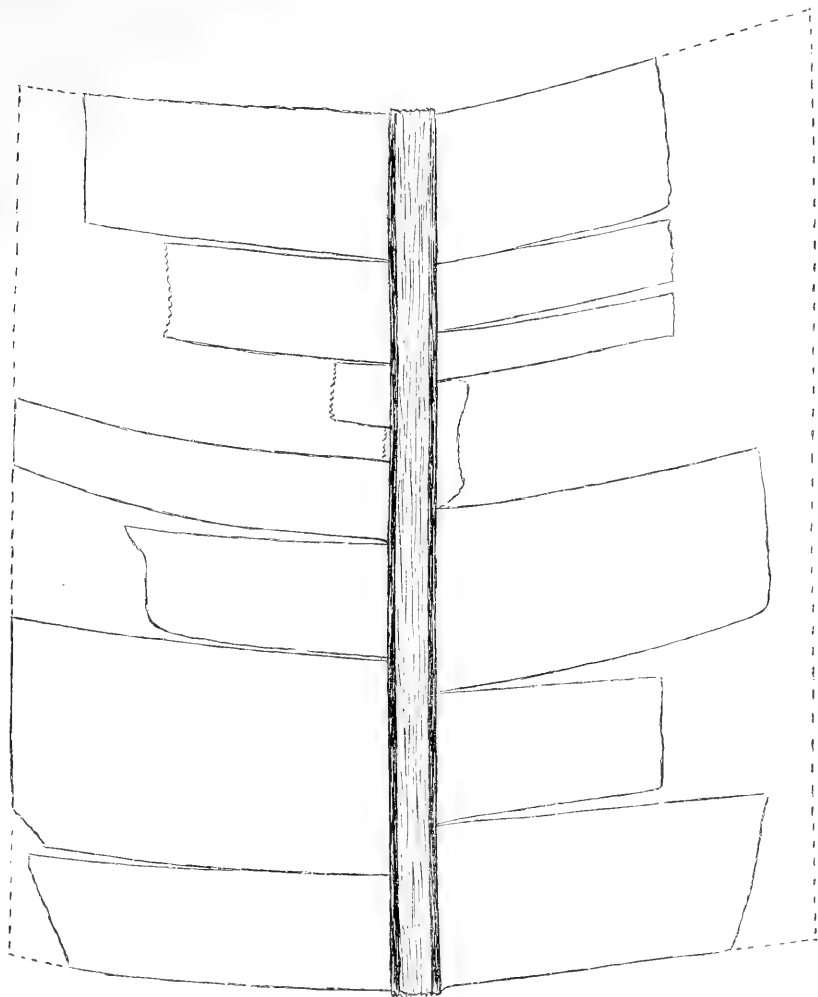

1

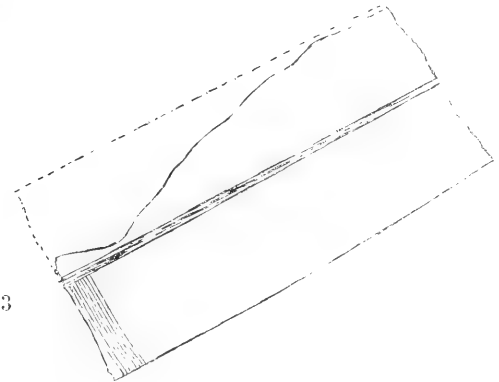

4

3

PLATE XXXII.

PLATE XXXII.

	Page.
FIGS. 1, 2. PLATYPTERIGIUM DENSINERVE, sp. nov.	169
1. Portion of the lower part of a leaf of large size.....	169
1 ^a . Portion of 1 slightly enlarged to show the nerves.....	169
2. Portion of the lower part of a leaf, showing a segment at <i>a</i> , triangular in shape....	169

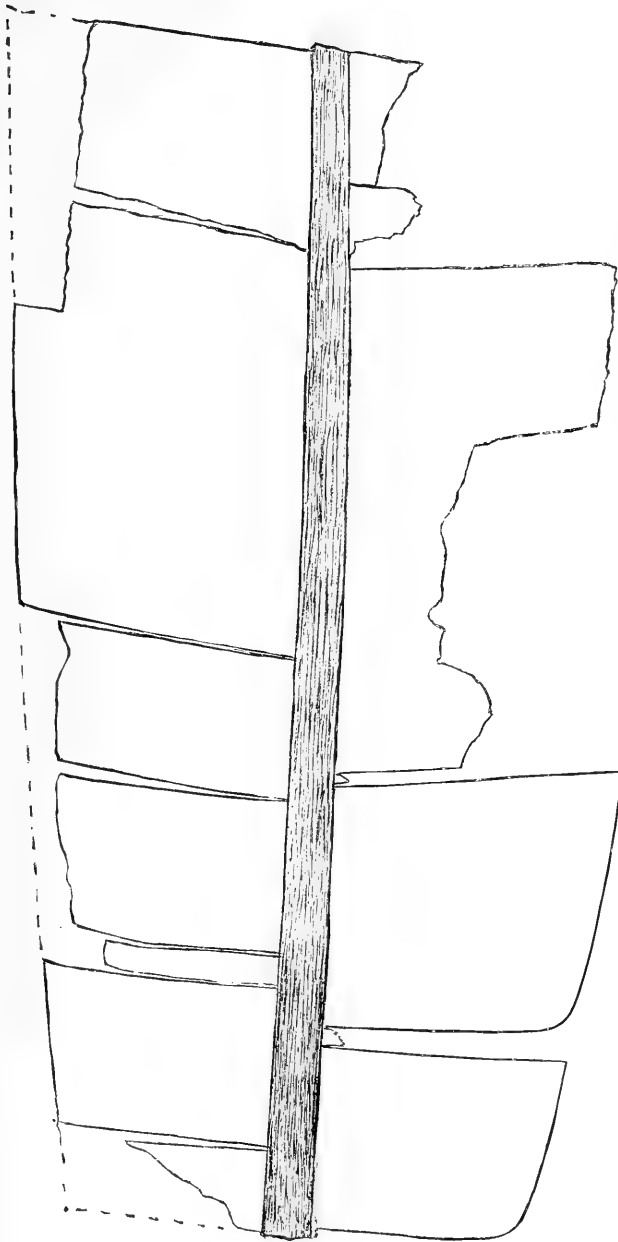

1

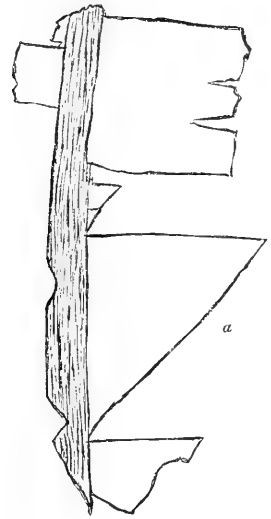

2

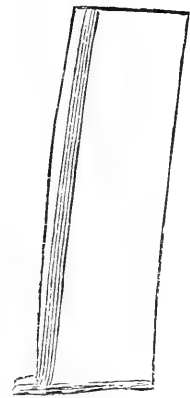

1^a

PLATE XXXIII.

PLATE XXXIII.

	Page.
FIG. 1. <i>PLATYPTERIGIUM DENSINERVE</i> , sp. nov.	169
1. Portion of a large leaf seen with upper surface uppermost, and showing ridges on the margin of the midrib.....	169
1 ^a . Portion of 1 magnified to show the nerves	169
FIG. 2. <i>PLATYPTERIGIUM ROGERSIANUM</i> , sp. nov.	171
2. Fragment of the middle (?) portion of a large leaf.....	171

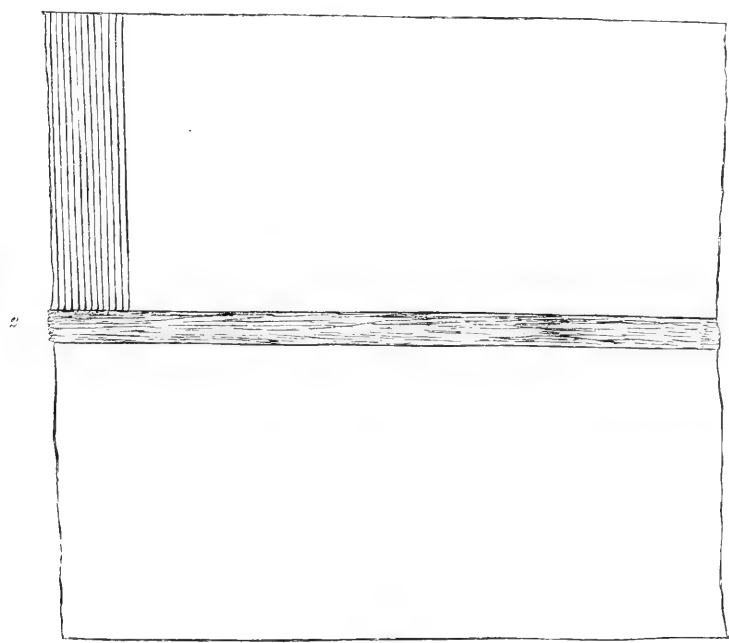
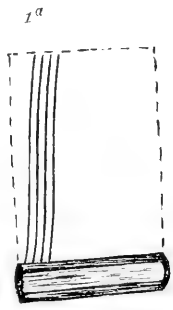
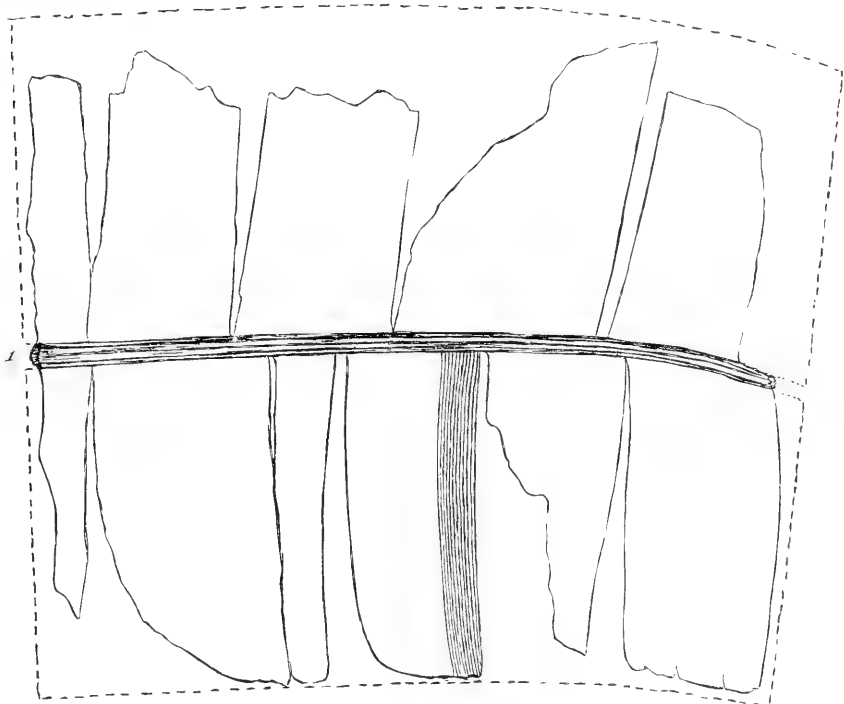
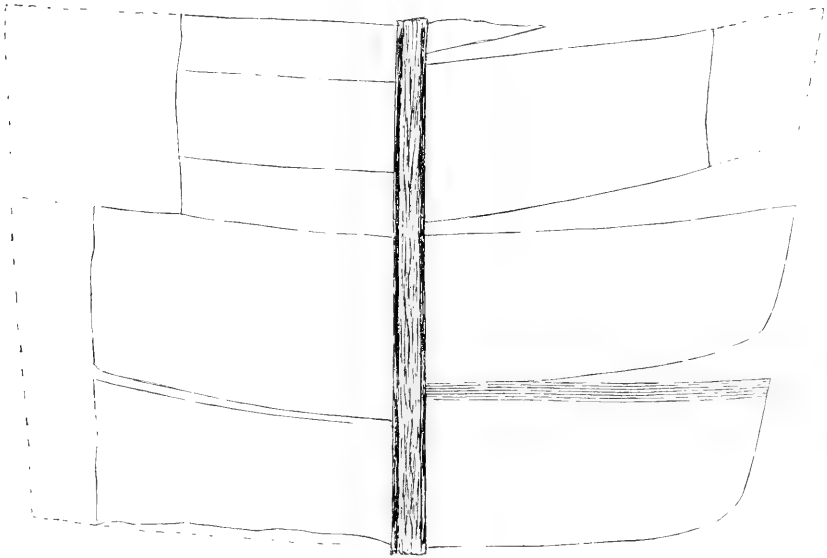

PLATE XXXIV.

PLATE XXXIV.

	Page.
FIG. 1. <i>PLATYPTERIGIUM DENSINERVE</i> , sp. nov.....	169
1. Portion of the leaf, showing the upper surface	169
FIG. 2. <i>PLATYPTERIGIUM ROGERSIANUM</i> , sp. nov.....	171
2. Portion of the leaf, showing segments.....	171
FIG. 3. <i>THYRSOPTERIS BREVIPENNIS</i> , sp. nov.....	124
3. Upper part of a compound pinna or of the frond.....	124
3 ^a . Pinnule of 3 magnified.....	124
FIG. 4. <i>SPIENOPTERIS ACRODENTATA</i> , sp. nov.....	90
4. Portion of a compound pinna or of the frond.....	90
4 ^a . Pinnule of 4 magnified.....	90

1



3



2

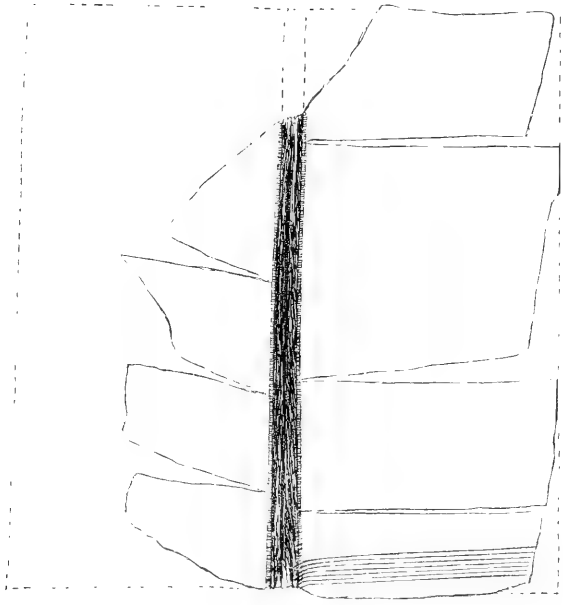
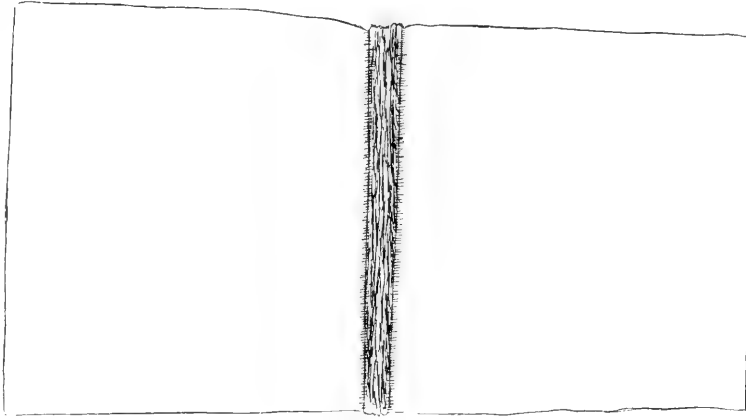

PLATE XXXV.

PLATE XXXV.

	Page.
FIGS. 1, 2. PLATYPTERIGIUM DENSINERVE, sp. nov.	169
1. Portion of a leaf, showing the under surface	169
2. Portion of a very wide leaf	169
FIGS. 3-5. SPHENOPTERIS LATILOBA, sp. nov.	90
3. End of a compound pinna	90
3a. Pinnule magnified	90
4. Portion of a compound pinna, showing some variation from the normal forms.....	90
4a. Pinnule of 4 magnified.....	90
5. Tip of a compound pinna	90

1



2^a



3



4



4^a



5



6

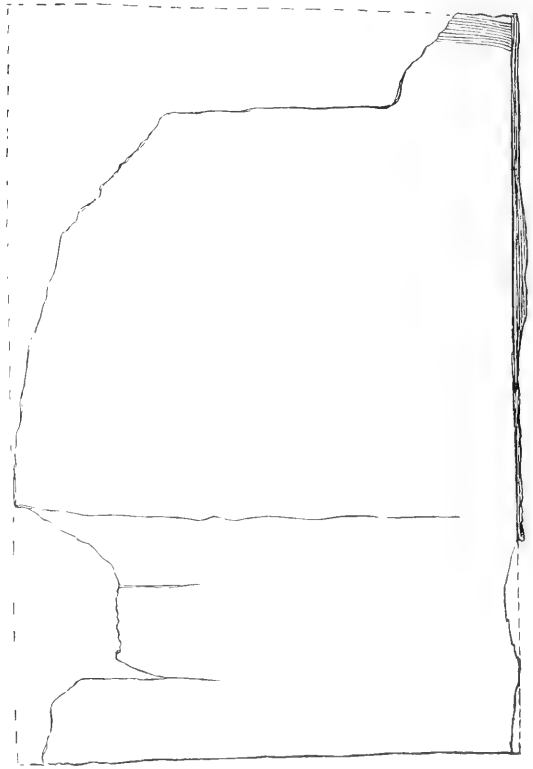

PLATE XXXVI.

MON XV—29

PLATE XXXVI.

	Page.
FIG. 1. CLADOPHLEBIS BREVIPENNIS, sp. nov.	81
1. Small fragment of a compound pinna.....	81
1 ^a . Pinna of 1 magnified.....	81
FIG. 2. THYRSOPTERIS BREVIPENNIS, sp. nov.	124
2. Upper part of a compound pinna.....	124
2 ^a . Pinnule of 2 magnified.....	124
FIG. 3. THYRSOPTERIS ALATA, sp. nov.	124
3. Portion of a compound pinna.....	124
3 ^a . Pinnule of 3 magnified.....	124
FIGS. 4-9. SPHENOPTERIS LATILOBA, sp. nov.	90
4. Tip of an ultimate pinna.....	90
5. Upper part of a flexuous compound pinna.....	90
5 ^a . Pinnule from the lower part of 5 magnified.....	90
6. Portion of frond or compound pinna, showing opposite compound pinna, pinnules mostly entire.....	90
7. Upper part of a compound pinna.....	90
7 ^a . Lower pinnule of 7 magnified.....	90
7 ^b . Upper pinnule of 7 magnified.....	90
8. Portion of a compound pinna, showing stoutness of rachis and remoteness of pinna and pinnules.....	90
9. Upper part of a compound pinna.....	90

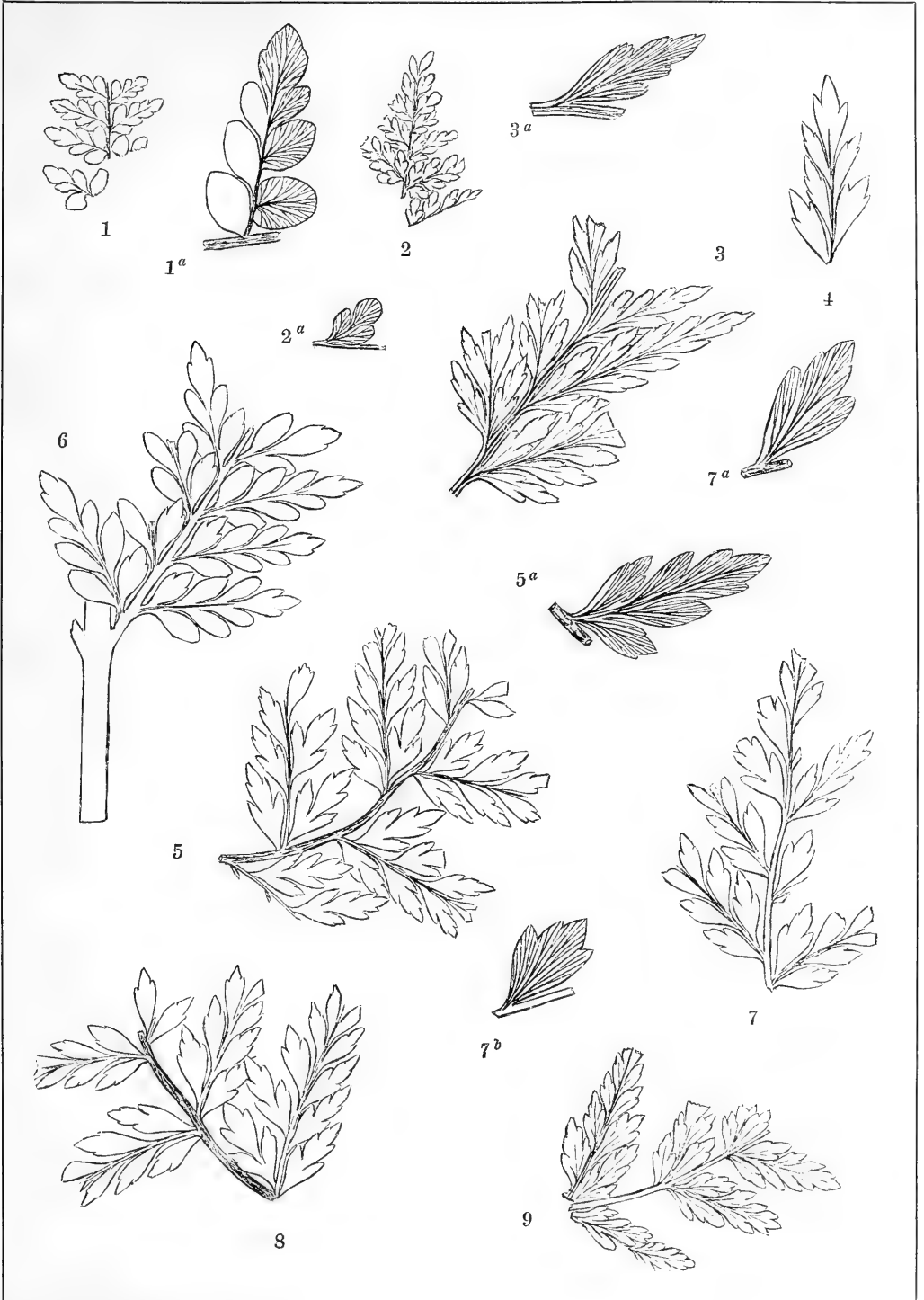

PLATE XXXVII.

PLATE XXXVII.

	Page.
FIG. 1. SPHENOPTERIS LATILOBA, sp. nov.	90
1. Summit of a compound pinna from Deep Bottom	90
FIGS. 2, 4. THYRSOPTERIS NERVOSA, sp. nov.	122
2. Fragments of a large compound pinna or of the frond.	122
2 ^a . Pinnule magnified	122
4. Upper part of a pinna	122
4 ^a . Pinnule magnified	122
FIGS. 3, 9. THYRSOPTERIS BREVIPENNIS, sp. nov.	124
3. Fragment of a compound pinna from Deep Bottom	124
9. Fragment from the top of a compound pinna, collected by Meek at Baltimore	124
FIGS. 5-8. THYRSOPTERIS DIVARICATA, sp. nov.	125
5. Summit of a compound pinna or of a frond	125
6. Upper portion of a compound pinna or a frond	125
6 ^a . Lower pinnule of 6 magnified	125
6 ^b . Upper pinnule of 6 magnified	125
7. Fragment of a compound pinna	125
7 ^a . Pinnule of 7 magnified	125
8. Upper part of a compound pinna or of a frond	125

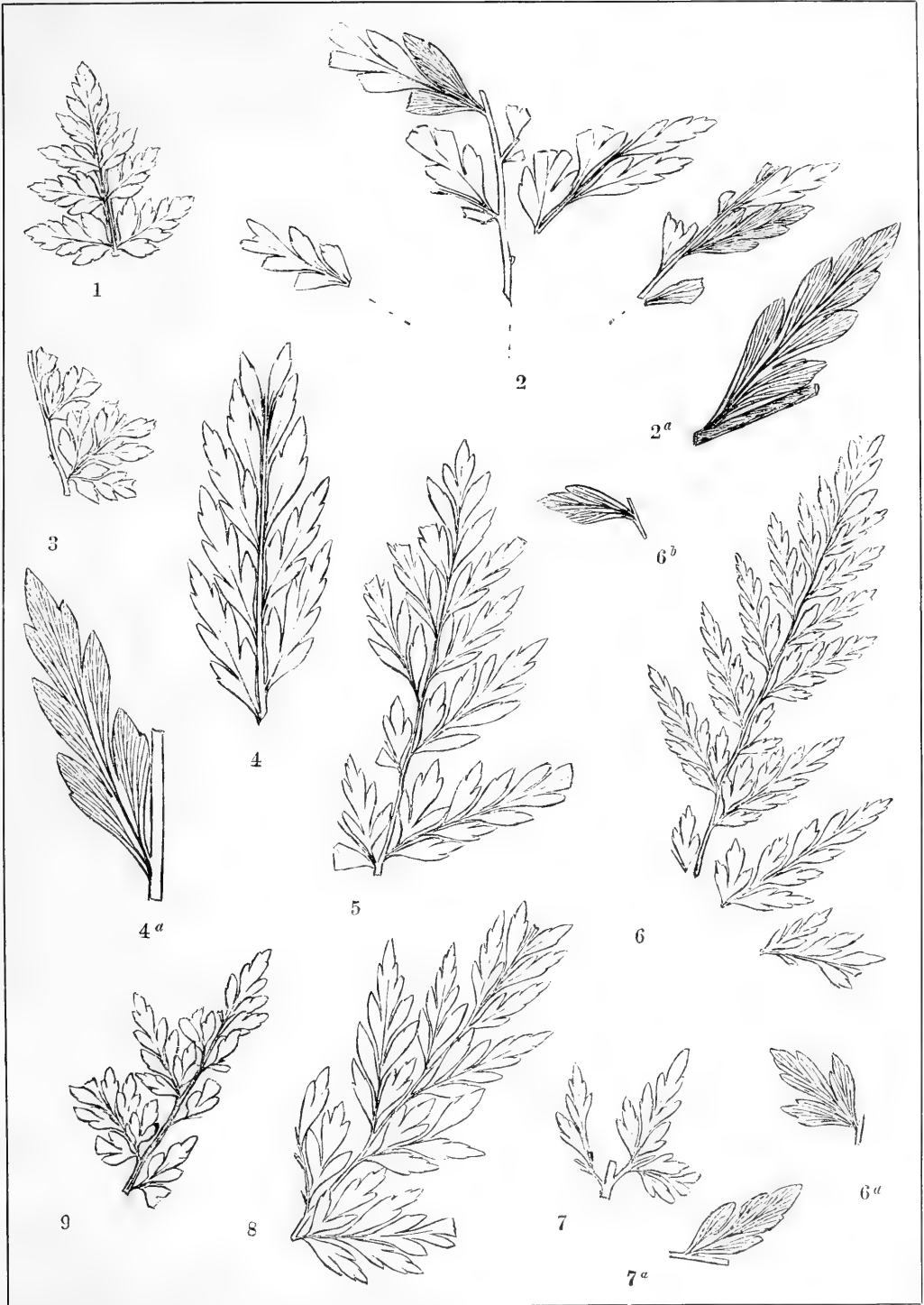

PLATE XXXVIII.

PLATE XXXVIII.

	Page-
FIG. 1. THYRSOPTERIS BREVIDENNIS, sp. nov	124
1. Portion of a compound primary pinna or of the frond	124
1 ^a . A lower pinnule of 1 magnified	124
1 ^b . Upper pinnule magnified	124
FIGS. 2-4. THYRSOPTERIS MEEKIANA, sp. nov	125
2. Portion of a primary pinna or of the frond	125
2 ^a . Lower pinnule of 2 magnified	125
2 ^b . Upper pinnule magnified	125
3. Portion of the upper part of the frond	125
3 ^a . Pinnule magnified	125
4. Upper part of a compound pinna	125
4 ^a . Pinnule magnified	125
8. Upper part of a compound pinna	125
FIGS. 5-7. THYRSOPTERIS MEEKIANA, var. ANGUSTILOBA, sp. nov	126
5. Portion of a compound pinna	126
5 ^a . Pinna magnified	126
6. Portion of a small compound pinna	126
7. Upper part of an ultimate pinna	126
9. Portion from near the end of an ultimate pinna	126
9 ^a . Pinnule magnified	126

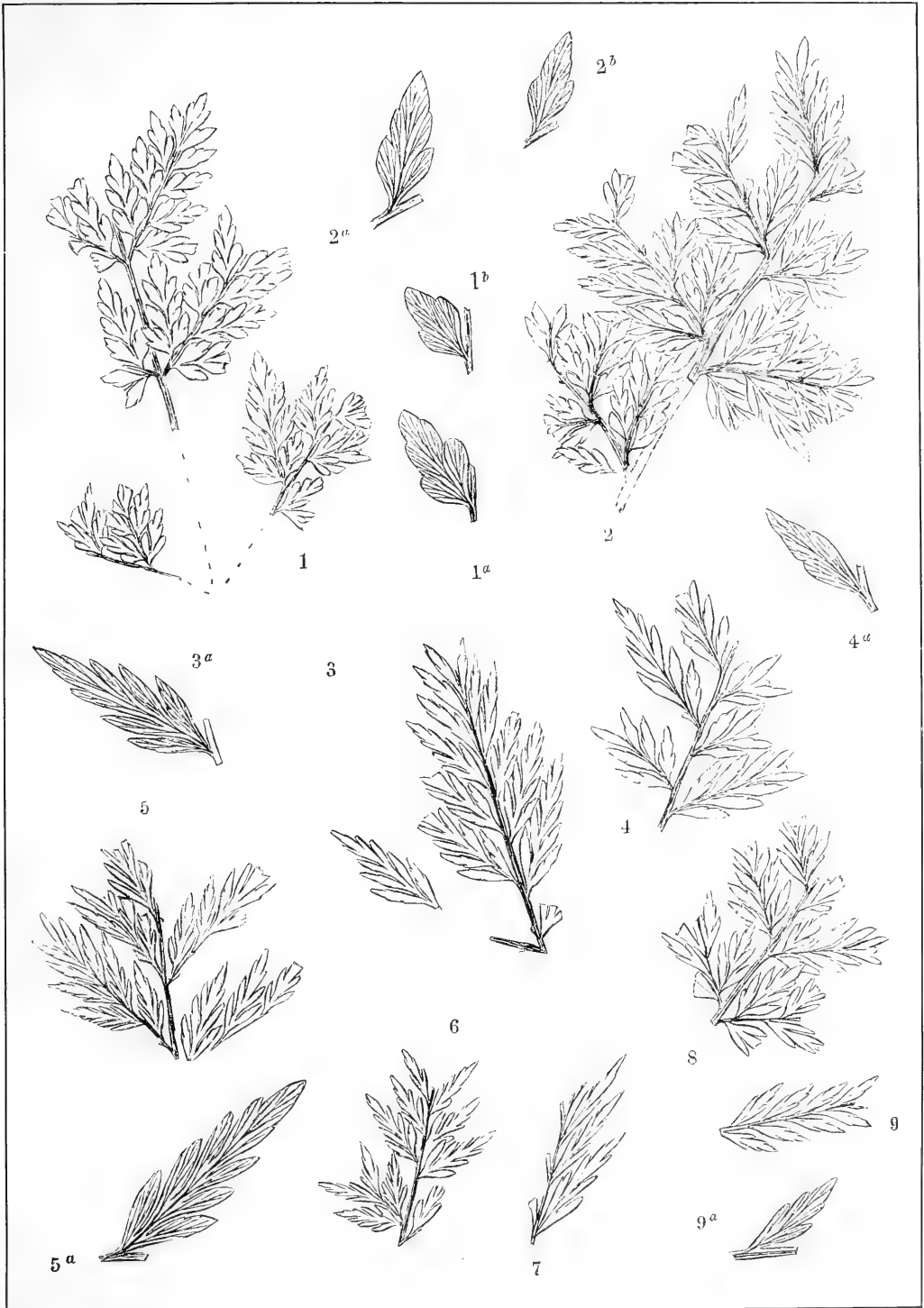

PLATE XXXIX.

PLATE XXXIX.

		Page.
FIGS. 1, 2.	THYRSOPTERIS CRENATA, sp. nov.	127
	1. Upper portion of a primary pinna, or of the frond, slightly restored.....	127
	1 ^a . Lower pinnule magnified	127
	2. Upper portion of a compound pinna, slightly restored.....	127
	2 ^a . Lower pinnule of 2 magnified.....	127
	2 ^b . Upper pinnules magnified	127
FIG.	3. THYRSOPTERIS DENSIFOLIA, sp. nov.	129
	3. Upper portion of a compound pinna or of the frond	129
	3 ^a . Pinnule magnified	129
FIG.	4. THYRSOPTERIS INSIGNIS, sp. nov.	127
	4. Portion of the lower part of the frond or of a large compound pinna.....	127
	4 ^a . Pinnule magnified	127
FIG.	5. THYRSOPTERIS NERVOSA, sp. nov.	122
	5. Fragment of an ultimate pinna	122

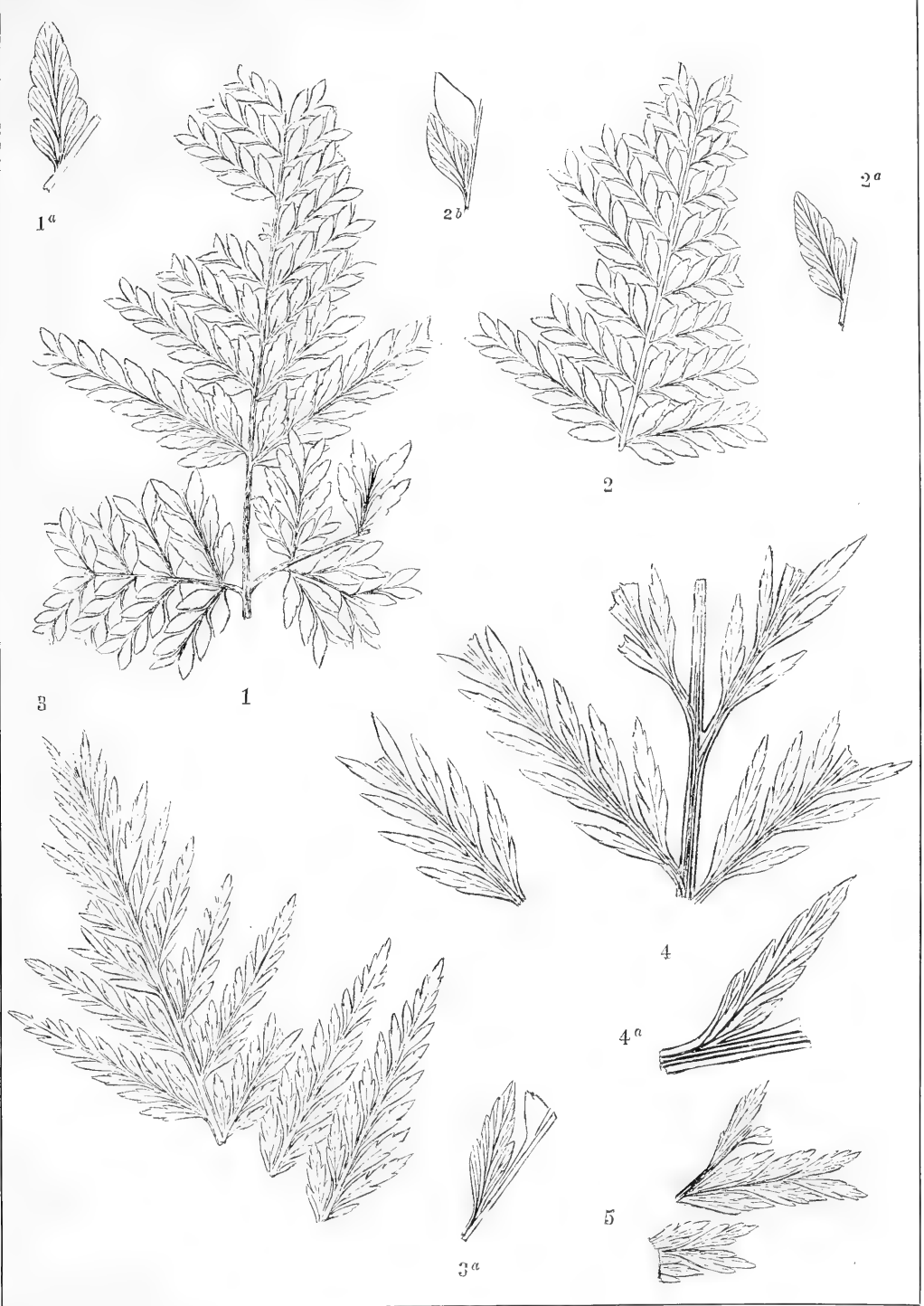

PLATE XL.

PLATE XL.

	Page.
FIG. 1. <i>THYRSOPTERIS INSIGNIS</i> , sp. nov.	127
1. Fragment of a compound pinna.....	127
1 ^a . Pinnule magnified, nerves not made out.....	127
FIGS. 2-5. <i>THYRSOPTERIS DENSIFOLIA</i> , sp. nov.	129
2. Fragment of the frond or of a primary pinna.....	129
2 ^a . Pinnule magnified.....	129
3. Upper part of a compound pinna.....	129
3 ^a . Lower pinnules of 3 magnified.....	129
3 ^b . Upper pinnule magnified.....	129
4. Upper portion of a compound pinna, slightly restored.....	129
5. Upper part of a compound pinna with flexuous rachis.....	129
FIG. 6. <i>THYRSOPTERIS NERVOSA</i> , sp. nov.	122
6. Fragments of the upper part of a compound pinna.....	122
6 ^a . Pinnule magnified.....	122

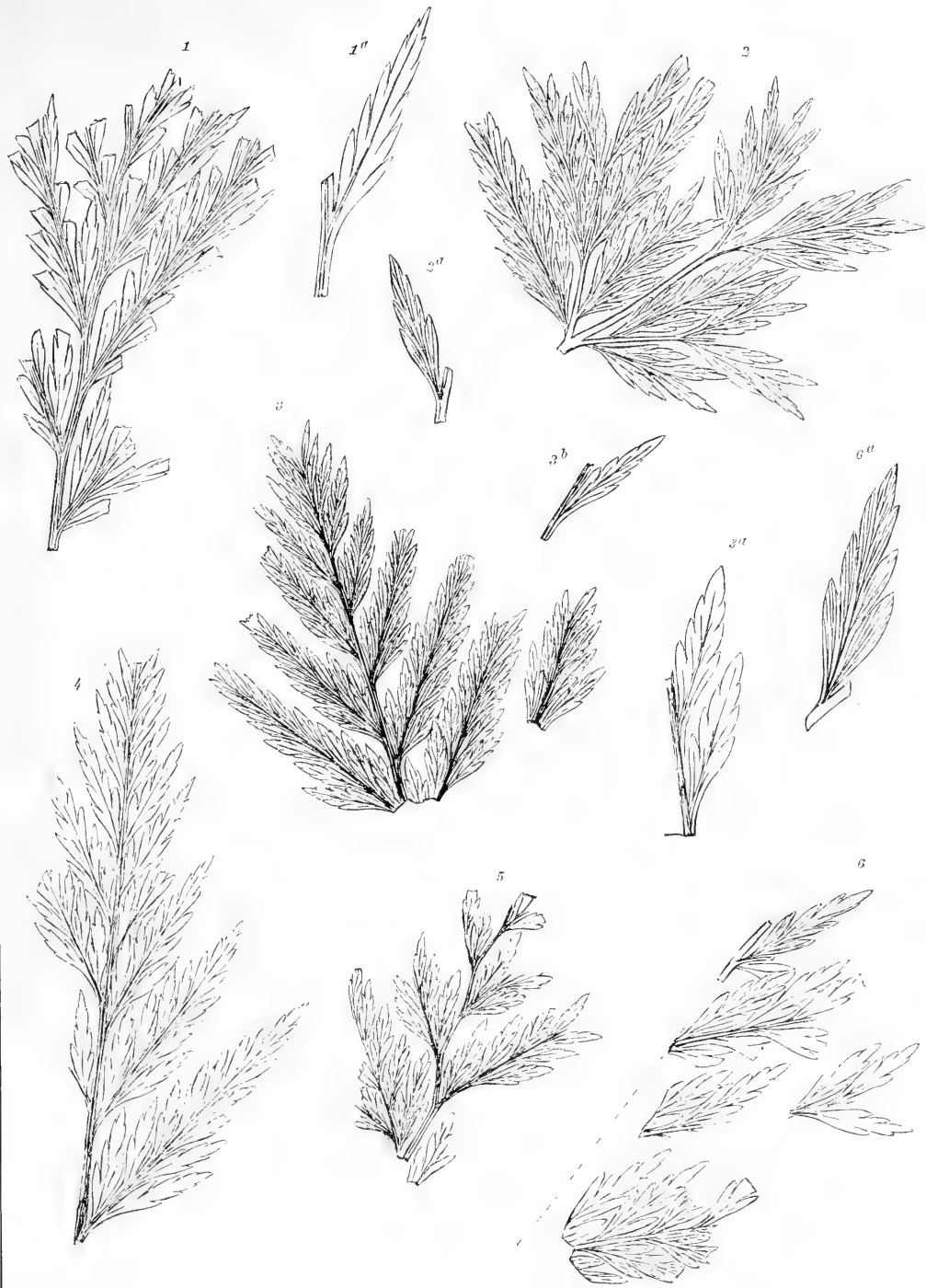

PLATE XLI.

PLATE XLI.

	Page.
FIGS. 1-3. <i>THYRSOPTERIS CRASSINERVIS</i> , sp. nov.	130
1. Upper part of a compound pinna	130
1 ^a . Lower pinnule magnified	130
1 ^b . Upper pinnule magnified	130
2. Part of a compound pinna	130
2 ^a . Lower pinnule of 2 magnified	130
2 ^b . Upper pinnules of 2 magnified	130
3. Summit of a long compound pinna	130
3 ^a . Lower pinnule of 3 magnified	130
3 ^b . Upper pinnule of 3 magnified	130
FIG. 4. <i>THYRSOPTERIS BREVIPENNIS</i> , sp. nov.	124
4. Fragment of a compound pinna	124
4 ^a . Pinnule of 4 magnified	124
FIG. 5. <i>OSMUNDA DICKSONIODES</i> , sp. nov.	146
5. Small fragment from the upper part of a compound pinna	146
5 ^a . Pinnule magnified	146
FIG. 6. <i>THYRSOPTERIS INSIGNIS</i> , sp. nov.	127
6. Fragments of a large primary pinna or of the frond	127
6 ^a . Pinnule magnified	127

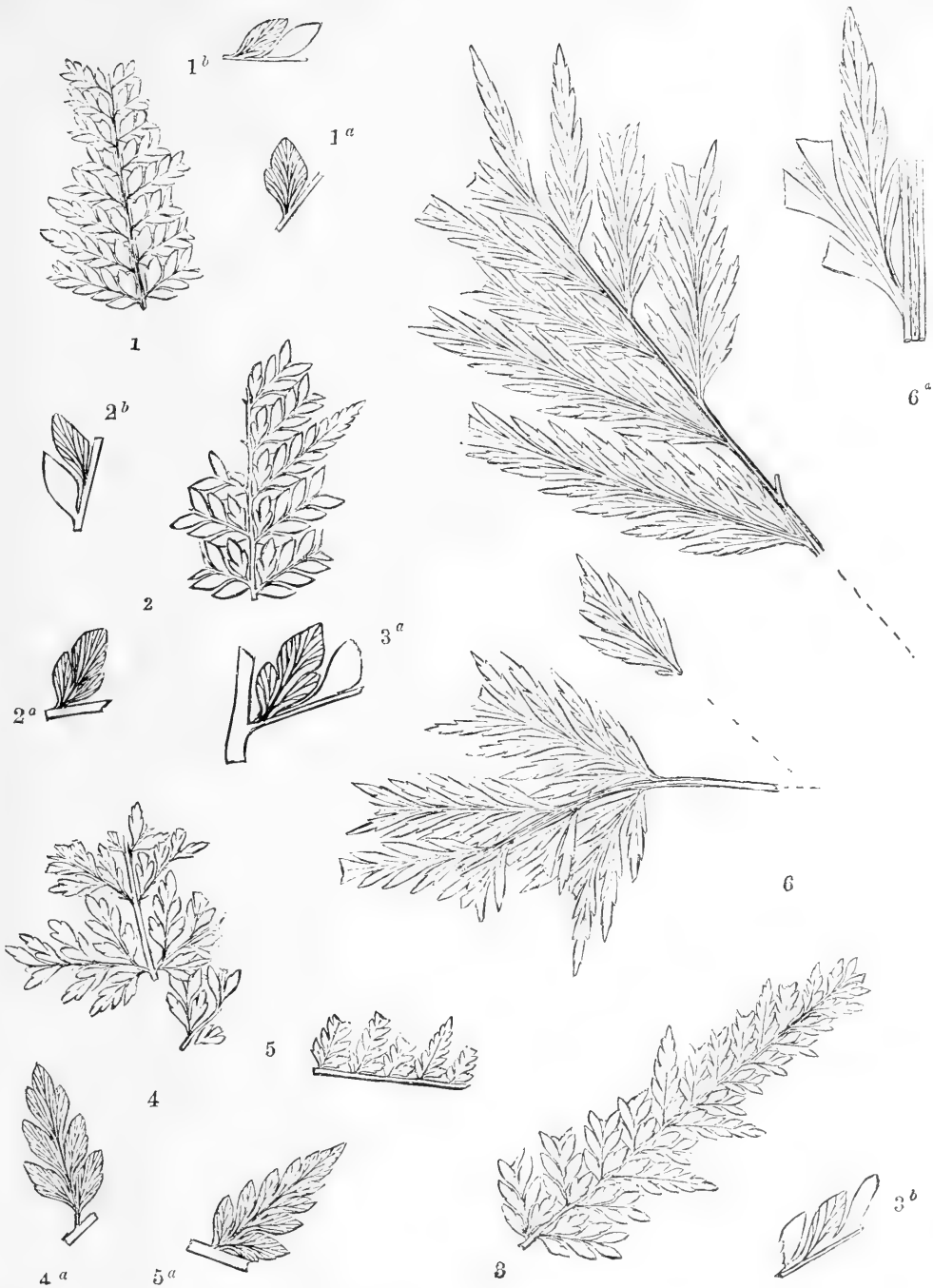

PLATE XLII.

PLATE XLII.

	Page.
FIGS. 1, 2, 4. THYRSOPTERIS INSIGNIS, sp. nov.	127
1. Fragment of a large compound pinna, or of the frond, slightly restored.	127
2. Fragment of a compound pinna.	127
2 ^a . Pinnule of 2 magnified.	127
4. Portion of the upper part of a compound pinna.	127
4 ^a . Pinnule of 4 enlarged.	127
FIG. 3. THYRSOPTERIS INSIGNIS, var. ANGUSTIPENNIS, sp. nov.	128
3. Portion of a compound pinna.	128
3 ^a . Lower pinnule of 3 magnified.	128
3 ^b . Upper pinnule magnified.	128



1



3^b



3^a

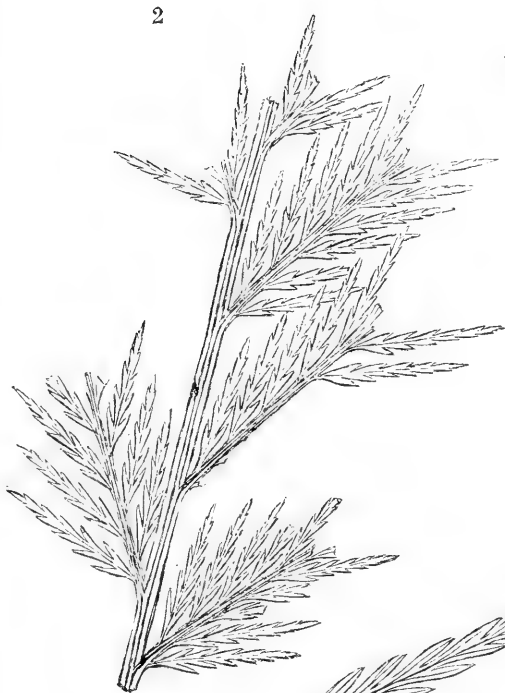

2



3



2^a



4



4^a

PLATE XLIII.

PLATE XLIII.

	Page.
FIGS. 1, 3. <i>THYRSOPTERIS INSIGNIS</i> , sp. nov.	127
1. Tip of an ultimate pinna	127
3. Portions of a compound pinna or of the frond	127
FIG. 2. <i>THYRSOPTERIS INSIGNIS</i> , var. <i>ANGUSTIPENNIS</i> , sp. nov.	128
2. Portions of two ultimate pinnae	128
2 ^a . Pinnule magnified	128
FIGS. 4-6. <i>THYRSOPTERIS RARINERVIS</i> , sp. nov.	123
4. Upper part of an ultimate pinna	123
4 ^a . Pinnules magnified	123
5. Upper part of a compound pinna, showing pinnules reduced to lobes.....	123
6. Portion of an ultimate pinna	123
6 ^a . Pinnule magnified	123
FIG. 7. <i>THYRSOPTERIS DECURENS</i> , sp. nov.	130
7. Fragment of a compound pinna	130
7 ^a . Pinnule magnified	130
FIG. 8. <i>THYRSOPTERIS MEEKIANA</i> , var. <i>ANGUSTILOBA</i> , sp. nov.	126
8. Fragment of a compound pinna	126
8 ^a . Lower pinnule of 8 magnified.....	126
8 ^b . Upper pinnule magnified.....	126

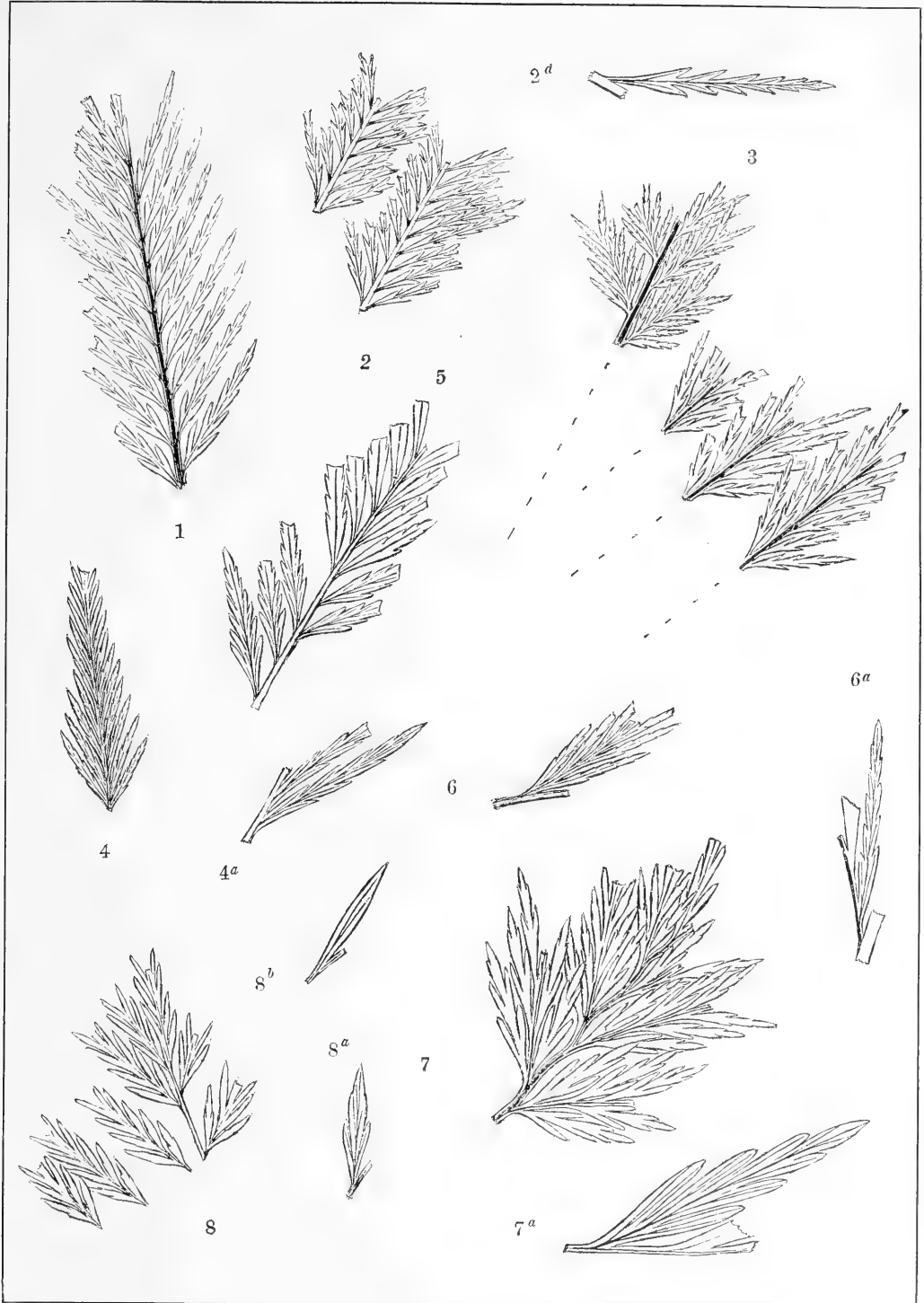

PLATE XLIV.

PLATE XLIV.

		Page.
FIGS. 1, 2, 5.	THYRSOPTERIS RARINERVIS, sp. nov. 1. Upper part of a compound pinna slightly restored 1 ^a . Pinnule of 1 magnified 2. Portion of a primary pinna, or of the frond, slightly restored 5. Fragment of a compound pinna 5 ^a . Pinnule of 5 magnified	123 123 123 123 123
FIG.	3. THYRSOPTERIS MEEKIANA, var. ANGUSTILOBA, sp. nov. 3. Fragments of compound pinnae	126 126
FIG.	4. THYRSOPTERIS ANGUSTIFOLIA, sp. nov. 4. Upper part of a compound pinna	131 131

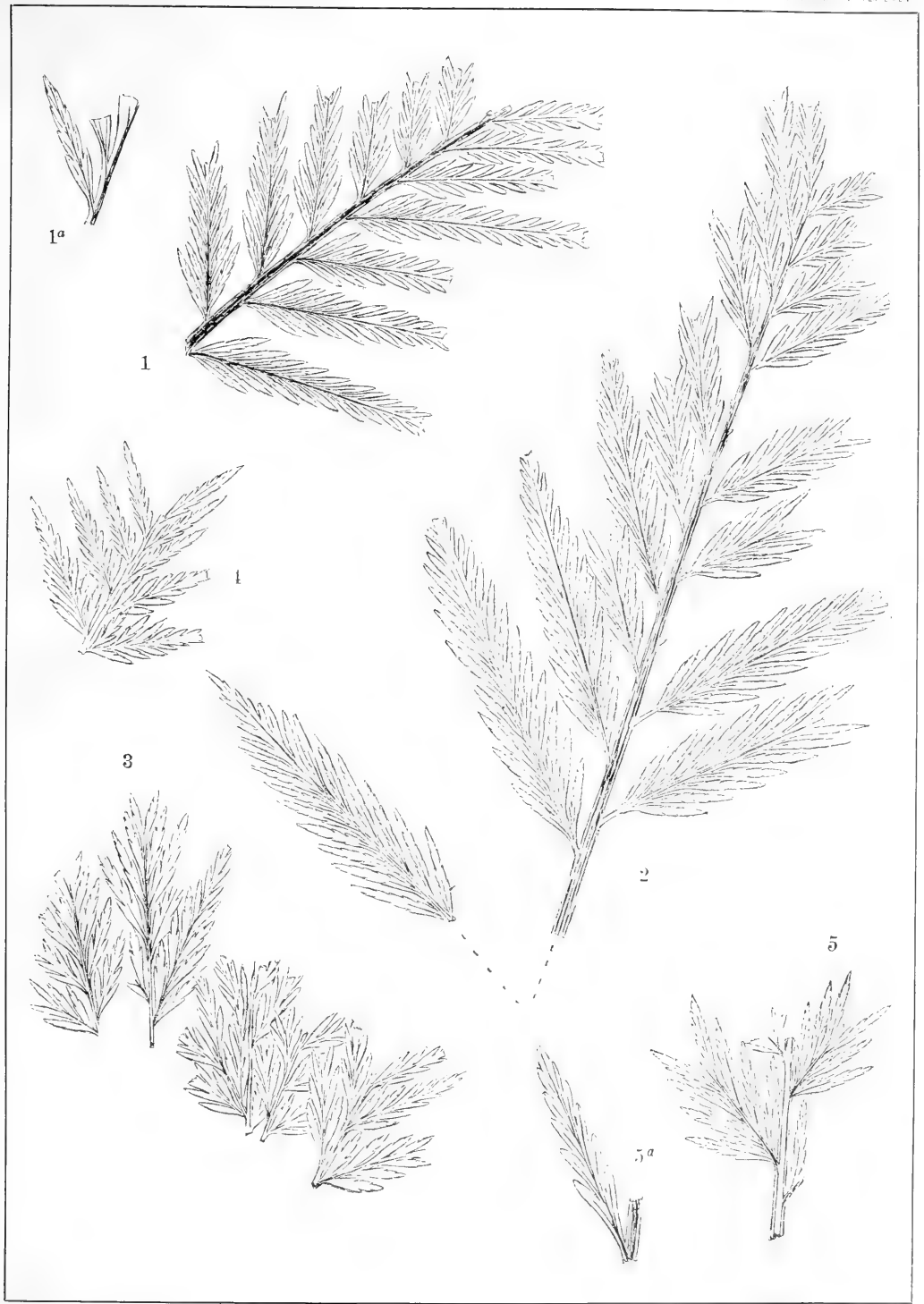

PLATE XLV.

PLATE XLV.

		Page.
Figs. 1, 2, 4, 5.	<p><i>THYRSOPTERIS MICROPHYLLA</i>, sp. nov.</p> <p>1. Portion of a large primary pinna, or of the frond, slightly restored.....</p> <p>1^a. Upper ultimate pinna or pinnule magnified</p> <p>1^b. Portion of a lower ultimate pinna magnified</p> <p>2. Upper part of a compound pinna, with the pinnules reduced to lobes</p> <p>2^a. Lower pinnule magnified</p> <p>4. Several detached upper ultimate pinnæ.....</p> <p>4^a. Pinnules magnified</p> <p>5. Portion of a small upper ultimate pinna, with the pinnules reduced to lobes...</p> <p>5^a. Pinnules or lobes magnified</p>	<p>131</p> <p>131</p> <p>131</p> <p>131</p> <p>131</p> <p>131</p> <p>131</p> <p>131</p> <p>131</p> <p>131</p> <p>131</p>
FIG.	<p>3. <i>THYRSOPTERIS ANGUSTIFOLIA</i>, sp. nov.</p> <p>3. Upper part of a compound pinna or of the frond.....</p> <p>3^a. Pinnule magnified</p>	<p>131</p> <p>131</p> <p>131</p>



PLATE XLVI.

P L A T E X L V I .

		Page.
FIG. 1.	1. THYRSOPTERIS ELLIPTICA, sp. nov.	133
	1. Fragments of several compound pinnae, showing apparently a palmate mode of branching.....	133
	1 ^a . Pinnules of 1 magnified	133
FIGS. 2, 4.	THYRSOPTERIS DECURRENS, sp. nov.	130
	2. Portion of a compound pinna	130
	2 ^a . Portion of 2 magnified	130
	4. Upper part of a compound pinna	130
FIGS. 3, 5.	THYRSOPTERIS PACHYRACHIS, sp. nov.	132
	3. Upper part of a large primary pinna, or of the frond, slightly restored	132
	3 ^a . Pinnule magnified	132
	5. Small fragment of a compound pinna.....	132

1^a



1

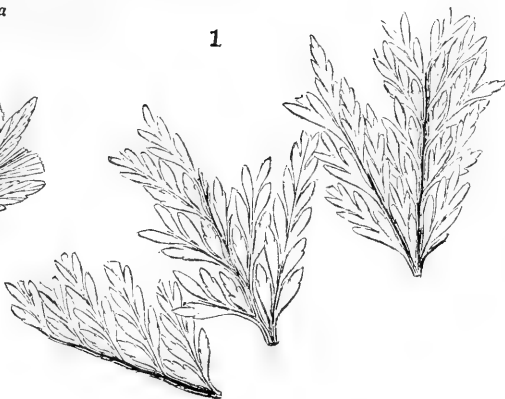

2

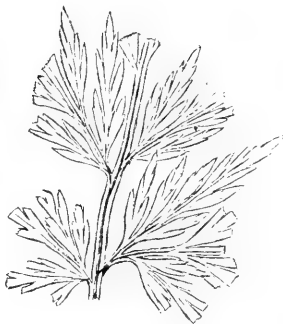

3

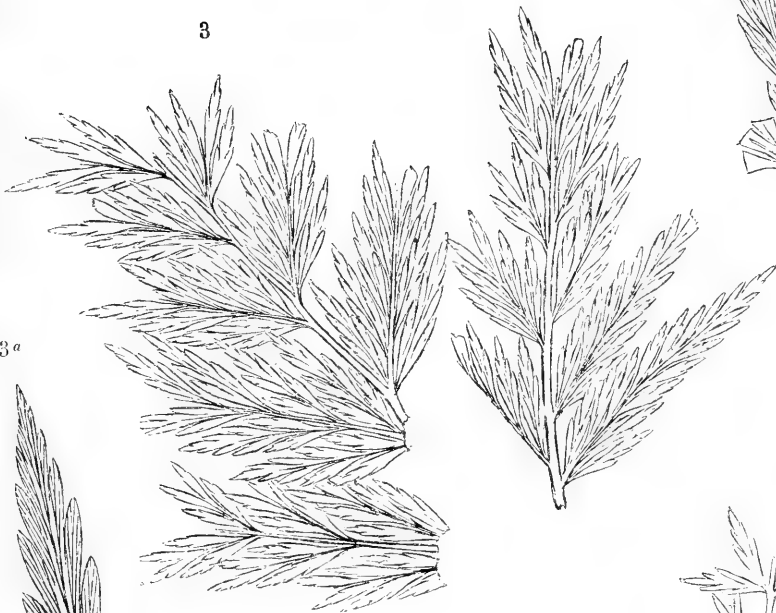

3^a



2^a



4



5

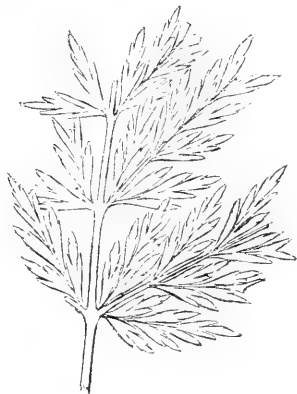

PLATE XLVII.

PLATE XLVII.

	Page.
FIGS. 1, 2. <i>THYRSOPTERIS PACHYRACHIS</i> , sp. nov	132
1. Two compound pinnae of a primary pinna or of the frond	132
1 ^a . Lower pinnule of 1 magnified	132
1 ^b . Upper pinnule of 1 magnified	132
2. Fragments of two ultimate pinnae	132
2 ^a . Pinnule of 2 magnified	132
FIG. 3. <i>THYRSOPTERIS DISTANS</i> , sp. nov	134
3. Portion of a large compound pinna or of the frond	134
3 ^a . Upper pinna of 3, when changed to pinnules, magnified	134
FIG. 4. <i>THYRSOPTERIS MEEKIANA</i> , var. <i>ANGUSTILOBA</i> , sp. nov	126
4. Fragments of the upper part of a compound pinna	126
4 ^a . Pinnule magnified	126

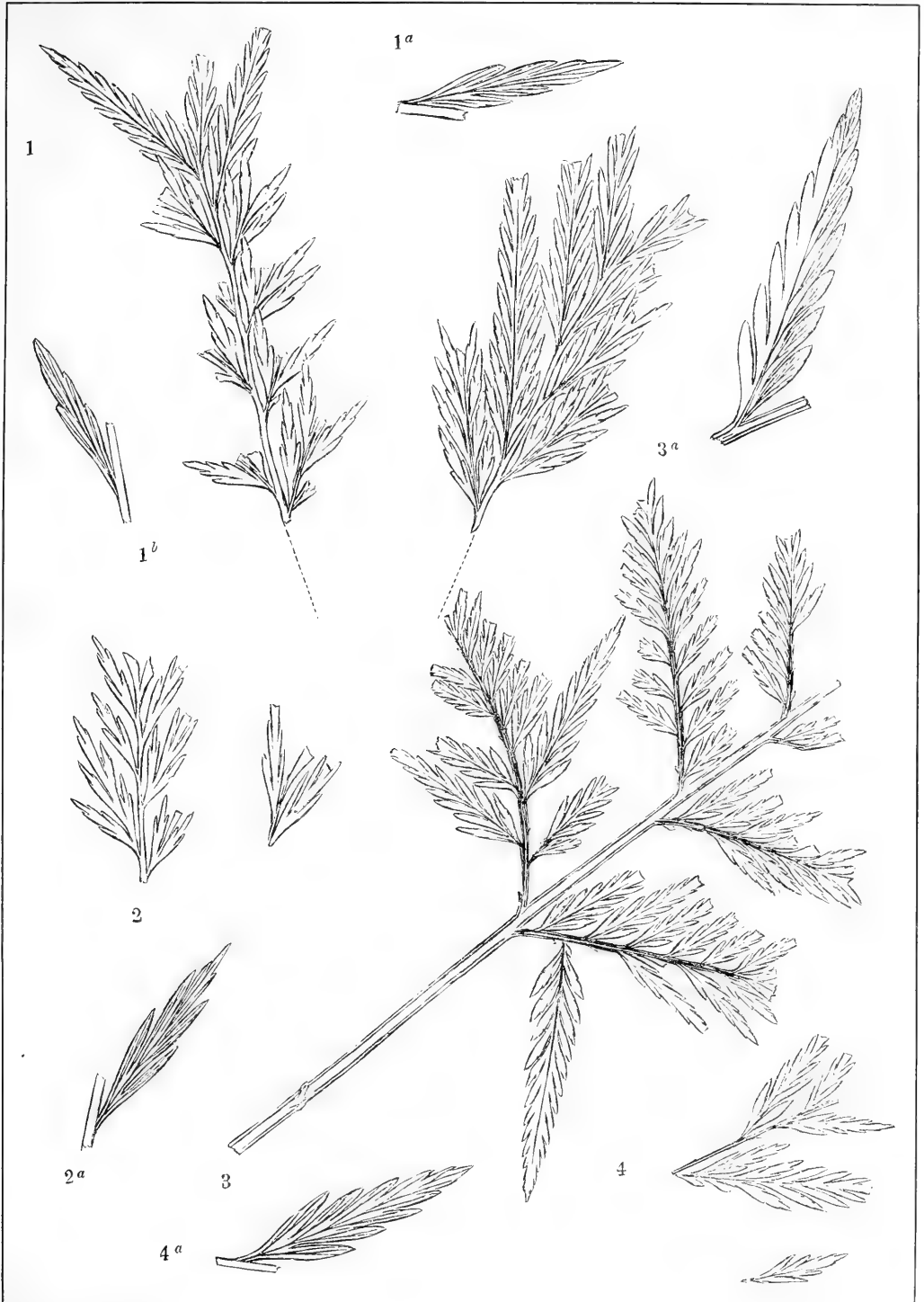

PLATE XLVIII.

P L A T E X L V I I I .

	Page.
FIG. 1. THYRSOPTERIS MEEKIANA, var. ANGUSTILOBA, sp. nov.	126
1. Portions of two compound pinnae.....	126
1 ^a . Ultimate pinna magnified.....	126
FIG. 2. THYRSOPTERIS ANGUSTIFOLIA, sp. nov.	131
2. Fragment of a compound pinna or of the frond.....	131
FIGS. 3-5. THYRSOPTERIS ANGUSTILOBA, sp. nov.	134
3. Summit of a primary pinna, or of the frond, slightly restored.....	134
3 ^a . Pinnule magnified.	134
4. Fragments of the upper part of a compound pinna or of the frond.....	134
4 ^a . Pinnule of 4 magnified.	134
5. Fragments of ultimate pinna.....	134
5 ^a . Pinnule of 5 magnified.....	134

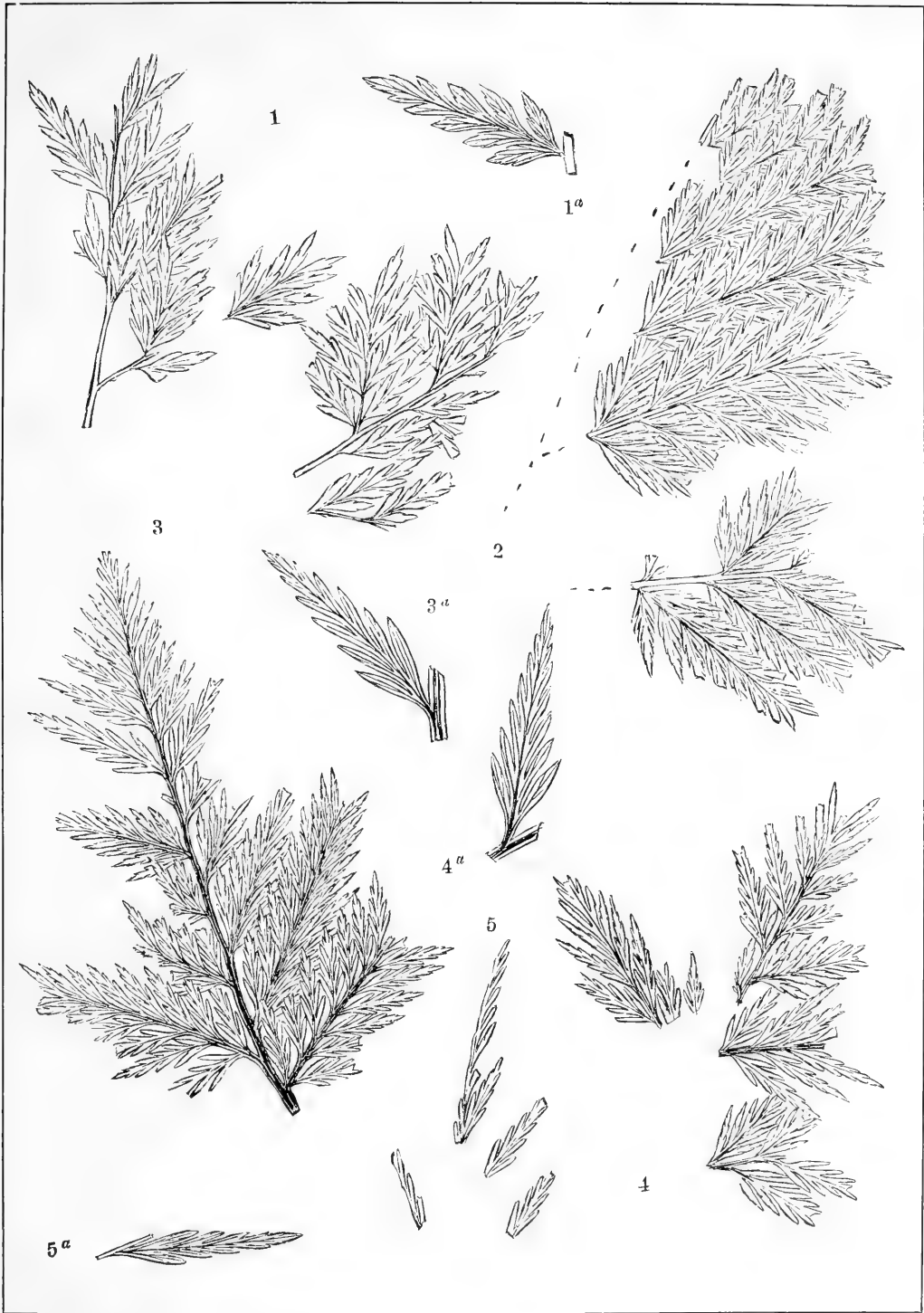

PLATE XLIX.

P L A T E X L I X .

		Page.
FIG. 1.	1. THYRSOPTERIS PACHYRACHIS, sp. nov.	132
	1. Fragment of a compound pinna or of the frond	132
	1 ^a . Ultimate pinna magnified	132
FIG. 2.	2. THYRSOPTERIS RARINERVIS, sp. nov.	123
	2. Portion of a primary pinna or of the frond	123
	2 ^a . Lower pinnule of 2 magnified	123
	2 ^b . Upper pinnule magnified	123
FIGS. 3, 4.	3, 4. THYRSOPTERIS ANGUSTIFOLIA, sp. nov.	131
	3, 4. Fragments of compound pinna	131
FIGS. 5-7.	5-7. THYRSOPTERIS DECURRENS, sp. nov.	130
	5. Fragment of the summit of a compound pinna	130
	5 ^a . Ultimate pinna magnified	130
	6. Fragments of a compound pinna	130
	6 ^a . Pinnule magnified	130
	7. Fragment of the upper part of an ultimate pinna	130

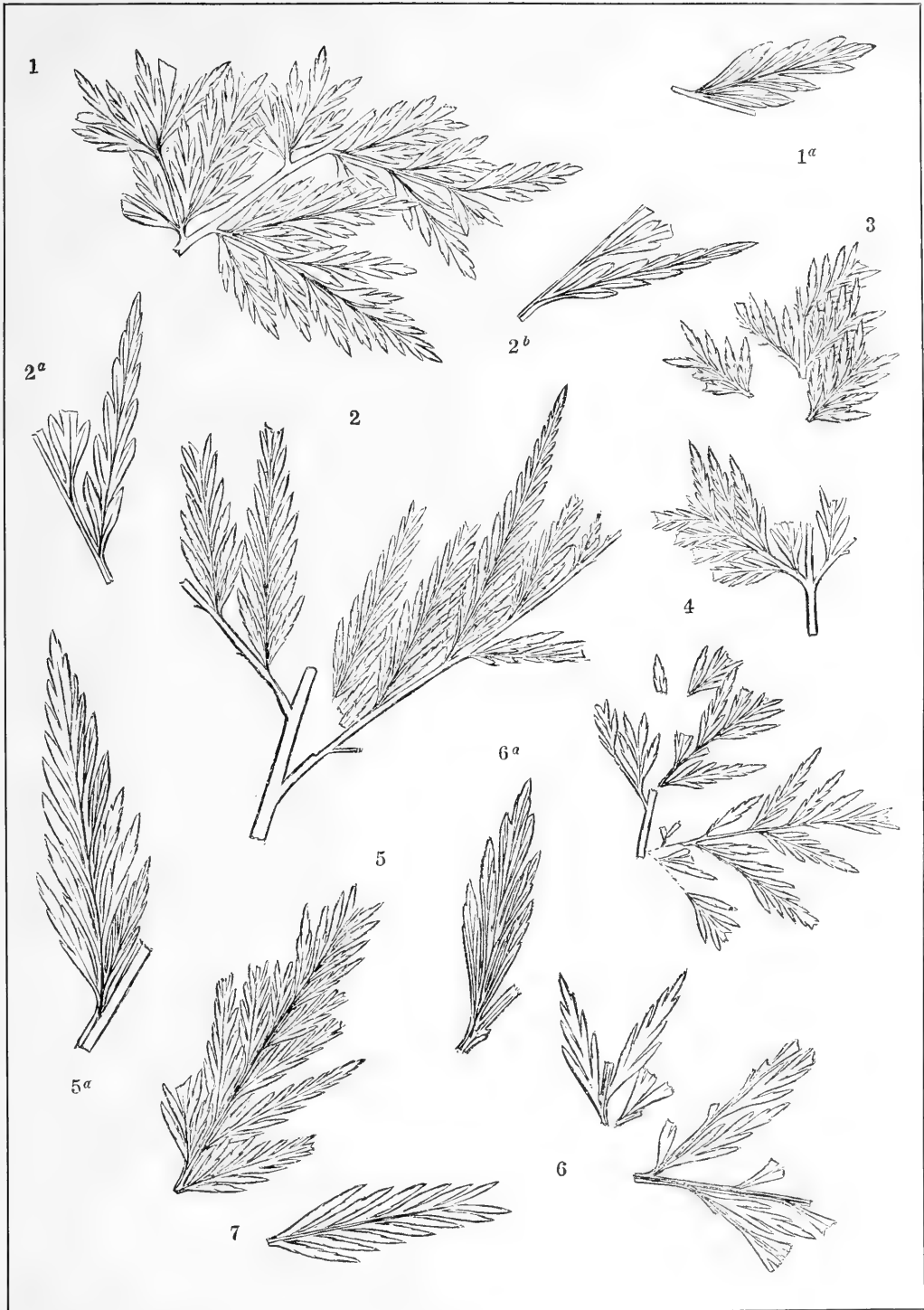

PLATE L.

PLATE L.

	Page.
FIGS. 1, 2. SPHENOPTERIS MANTELLI Brongn	91
1. Portions of compound pinnae	91
1 ^a . Pinnule magnified	91
2. Fragment of a compound pinna, or of the frond, showing a form with narrower pinnules and lobes	91
2 ^a . Pinnule magnified	91
FIG. 3. THYRSOPTERIS PACHYPHYLLA, sp. nov.	135
3. Small fragment of the tip of an ultimate pinna	135
FIG. 4. SPHENOPTERIS SPATULATA, sp. nov.	93
4. Small fragment of an ultimate pinna	93
FIG. 5. SPHENOPTERIS PACHYPHYLLA, sp. nov.	93
5. Small fragment of a compound pinna	93
5 ^a . Ultimate pinna magnified	93
FIGS. 6, 9. THYRSOPTERIS ELLIPTICA, sp. nov.	133
6. Fragments of detached compound pinnae	133
6 ^a . Pinnules magnified	133
9. Portion of the upper part of a compound pinna	133
FIGS. 7, 8. THYRSOPTERIS MEEKIANA, sp. nov.	125
7. Portion of the upper part of a compound pinna	125
7 ^a . Pinnule magnified	125
8. Upper portion of a long compound pinna	125

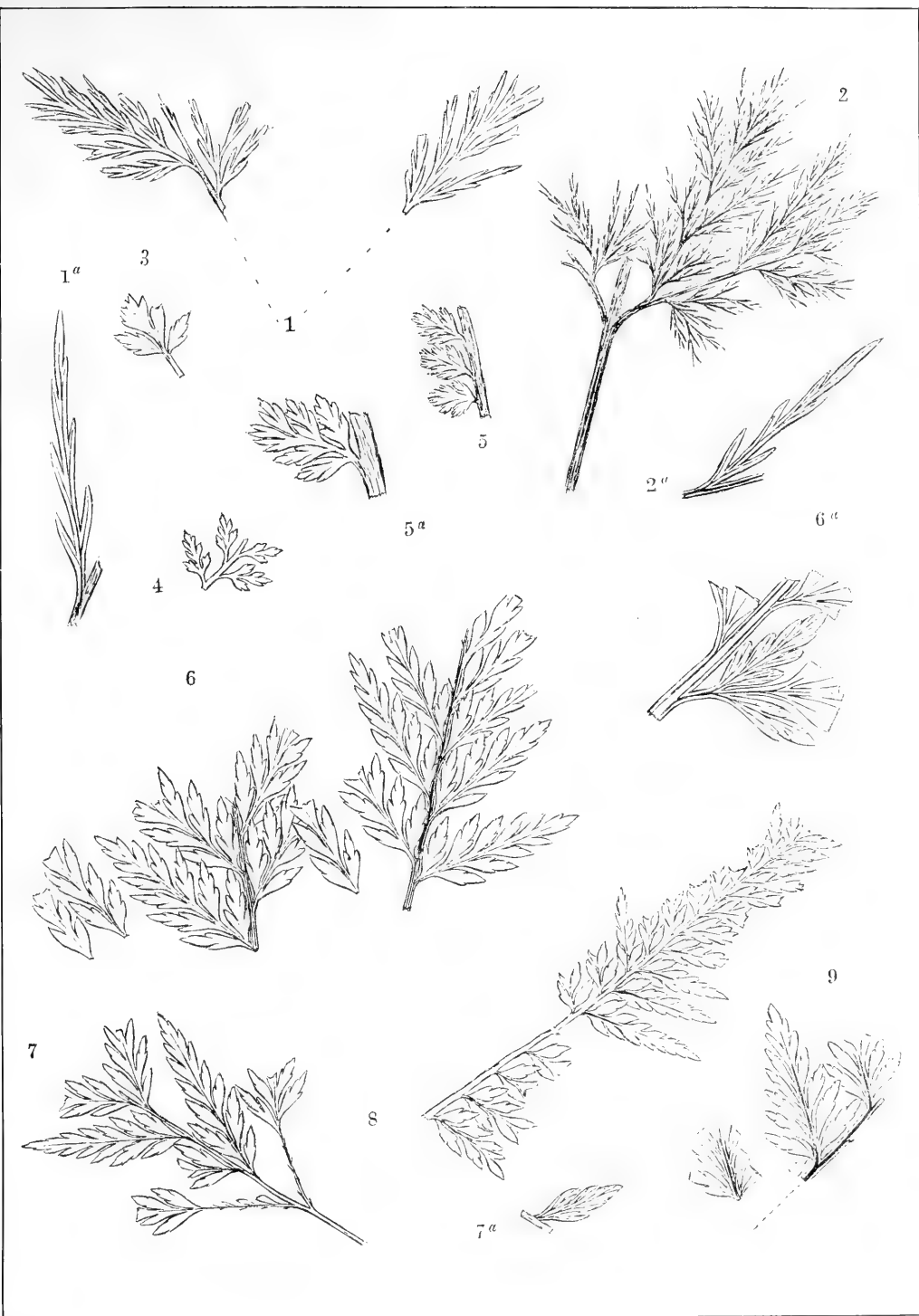

PLATE LI.

PLATE LI.

	Page.
FIG. 1. <i>THYRSOPTERIS PECOPTEROIDES</i> , sp. nov.	135
1. Portion of a compound pinna.	135
1 ^a , 1 ^b . Pinnules of 1 magnified.	135
FIG. 2. <i>THYRSOPTERIS PINNATIFIDA</i> , sp. nov.	136
2. Portion of a large compound pinna, slightly restored.	136
FIG. 3. <i>THYRSOPTERIS MEEKIANA</i> , sp. nov.	125
3. Upper part of a compound pinna.	125
3 ^a . Pinnule of 3 magnified.	125
FIGS. 4, 6, 7. <i>THYRSOPTERIS ELLIPTICA</i> , sp. nov.	133
4. Small fragment of a compound pinna.	133
6. Fragment of a large primary pinna, or of the frond, slightly restored.	133
6 ^a . Lower pinnules of 6 magnified.	133
6 ^b . Upper pinnule magnified.	133
7. Fragment from the upper part of a compound pinna.	133
FIG. 5. <i>THYRSOPTERIS DENSIFOLIA</i> , sp. nov.	129
5. Upper part of a compound pinna.	129

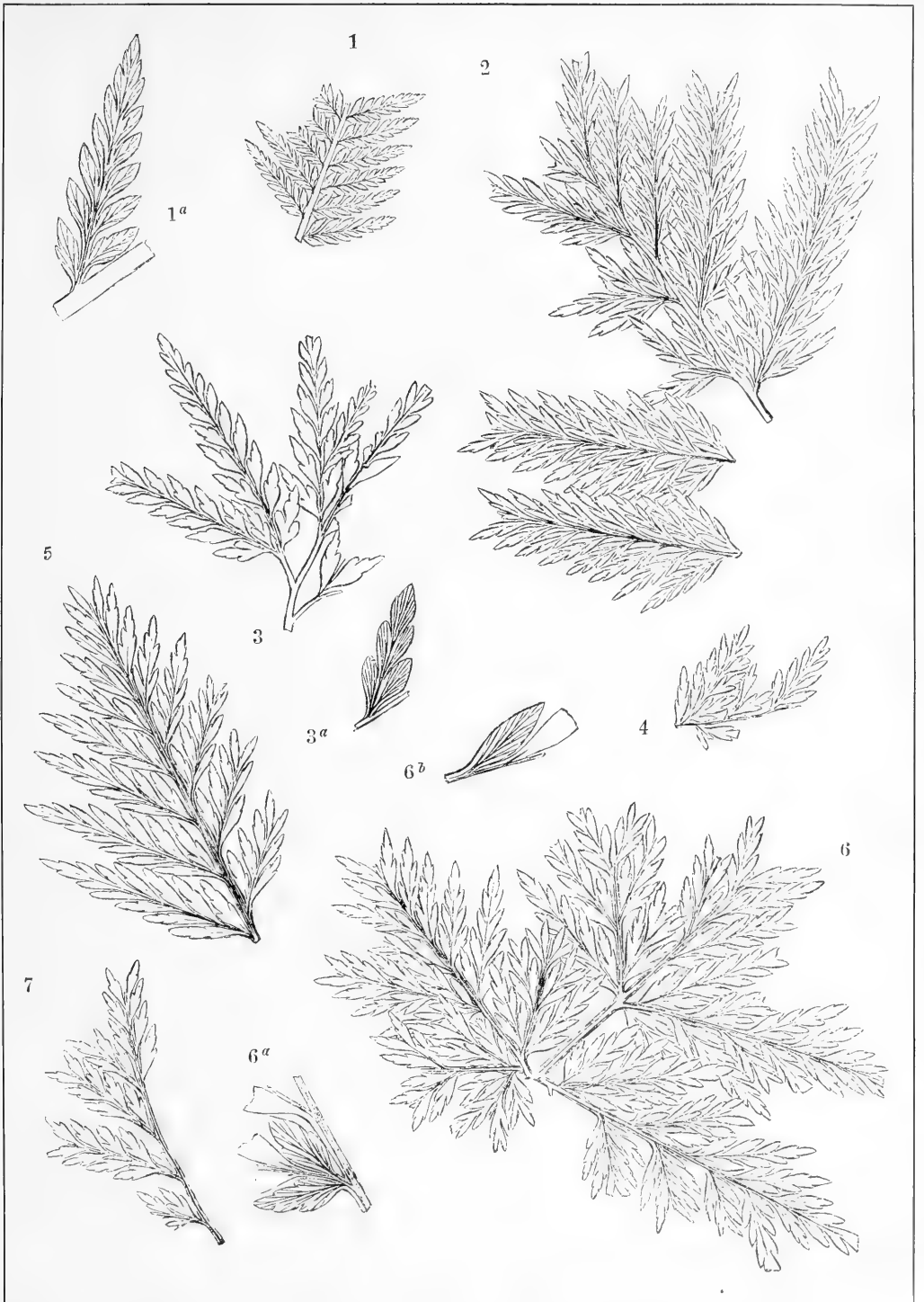

PLATE LII.

PLATE LII.

		Page.
FIG. 1.	1. <i>THYRSOPTERIS HETEROMORPHA</i> , sp. nov.	136
	1. This represents what seems to be the entire frond radiating from the top of the stipe.	136
	1 ^a . Lower pinnule of 1 magnified	136
	1 ^b . Upper pinnule magnified	136
FIGS. 2-4.	<i>THYRSOPTERIS VARIANS</i> , sp. nov.	137
	2. Summit of a compound pinna, slightly restored	137
	2 ^a . Pinnule of 2 magnified	137
	3. Portion of a lower compound pinna, slightly restored	137
	4. Portion of a lower compound pinna.	137
	4 ^a . Pinnule magnified	137
FIG. 5.	<i>THYRSOPTERIS RHOMBIFOLIA</i> , sp. nov.	138
	5. Portions of compound pinnae, apparently radiating from a common point, as in a frond palmately divided	138
	5 ^a . Ultimate pinna from the lower portion of a compound pinna magnified	138
	5 ^b . Upper pinna of the same magnified	138

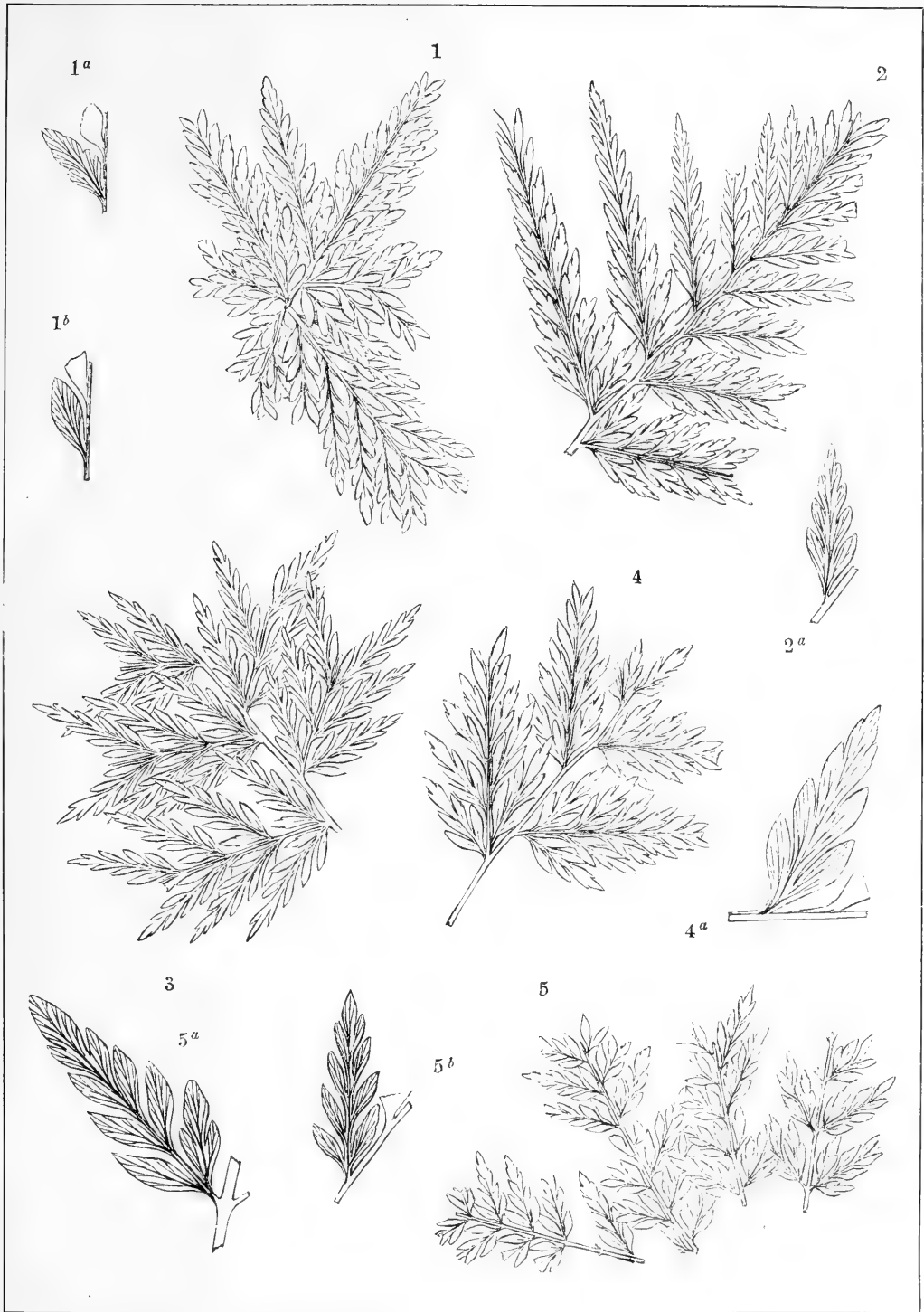

PLATE LIII.

PLATE LIII.

		Page.
FIGS. 1-3.	THYRSOPTERIS VARIANS, sp. nov.	137
	1. Portions of a compound pinna from the upper part of the frond, slightly restored ..	137
	1 ^a . Pinnule magnified	137
	2. Portion of a compound pinna from the upper part of the frond	137
	2 ^a . Pinnule magnified	137
	3. Portions of a compound pinna from the lower part of the frond	137
	3 ^a . Pinnules magnified	137
	3 ^b . Tip of a pinna magnified	137
FIG.	4. THYRSOPTERIS HETEROLOBA, sp. nov.	139
	4. Portion of a compound pinna, slightly restored	139
	4 ^a . Pinnules magnified	139
FIG.	5. THYRSOPTERIS BELLA, sp. nov.	139
	5. Fragment of the upper part of a compound pinna	139
	5 ^a . Ultimate pinna of 5 magnified.....	139

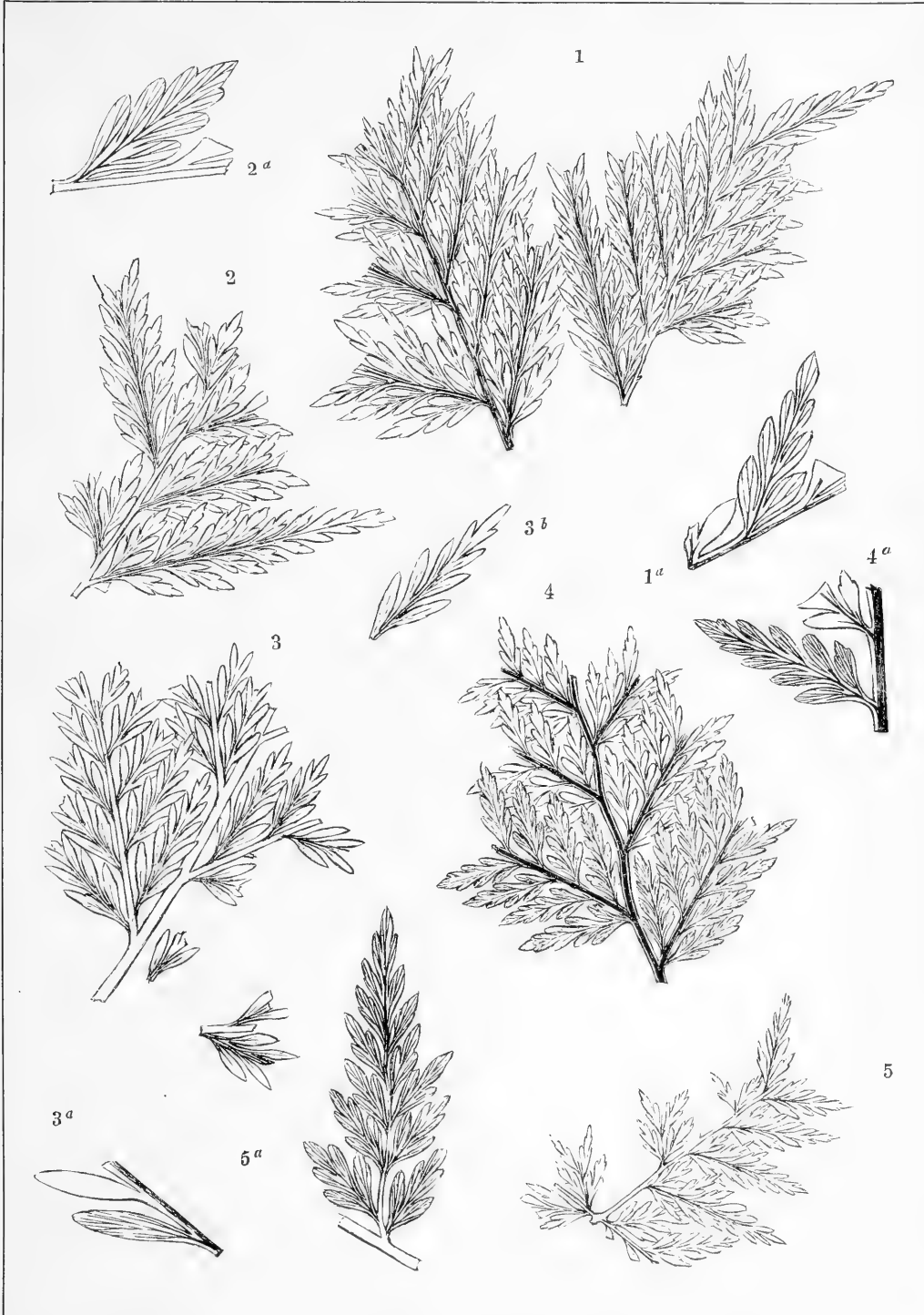

PLATE LIV.

PLATE LIV.

	Page.
FIG. 1. THYRSOPTERIS RHOMBIFOLIA, sp. nov.	138
1. Upper part of a compound pinna, differing in some respects from the normal form of <i>T. rhombifolia</i>	138
1 ^a . Ultimate lower pinna magnified	138
1 ^b . Ultimate upper pinna magnified	138
FIGS. 2, 11. THYRSOPTERIS MEEKIANA, var. ANGUSTILORA, sp. nov.	126
2. Small fragment of the upper part of a compound pinna	126
2 ^a . Pinnule magnified	126
11. Small fragment of a compound pinna	126
11 ^a . Pinnule magnified	126
FIGS. 3, 9. ASPIDIUM DUNKERI Schimper, sp.	101
3. Fragment of an upper ultimate pinna	101
3 ^a . Pinnules magnified	101
9. Fragment of an upper ultimate pinna	101
9 ^a . Pinnules magnified	101
FIGS. 4, 5, 7. THYRSOPTERIS PINNATIFIDA, sp. nov.	136
4. Fragment of a lower compound pinna	136
5. Portion of an upper compound pinna	136
7. Upper part of a compound pinna, slightly restored	136
7 ^a . Lower ultimate pinna magnified	136
7 ^b . Upper pinna magnified	136
FIG. 6. THYRSOPTERIS ELLIPTICA, sp. nov.	133
6. Fragment of a compound pinna or of the frond	133
FIG. 8. THYRSOPTERIS DISTANS, sp. nov.	134
8. Upper part of a compound pinna	134
8 ^a . Pinnule of 8 magnified	134
FIG. 10. THYRSOPTERIS VARIANS, sp. nov.	137
10. Upper part of a compound pinna, showing unusually narrow and remote pinnules	137
10 ^a . Pinnules of 10 magnified	137

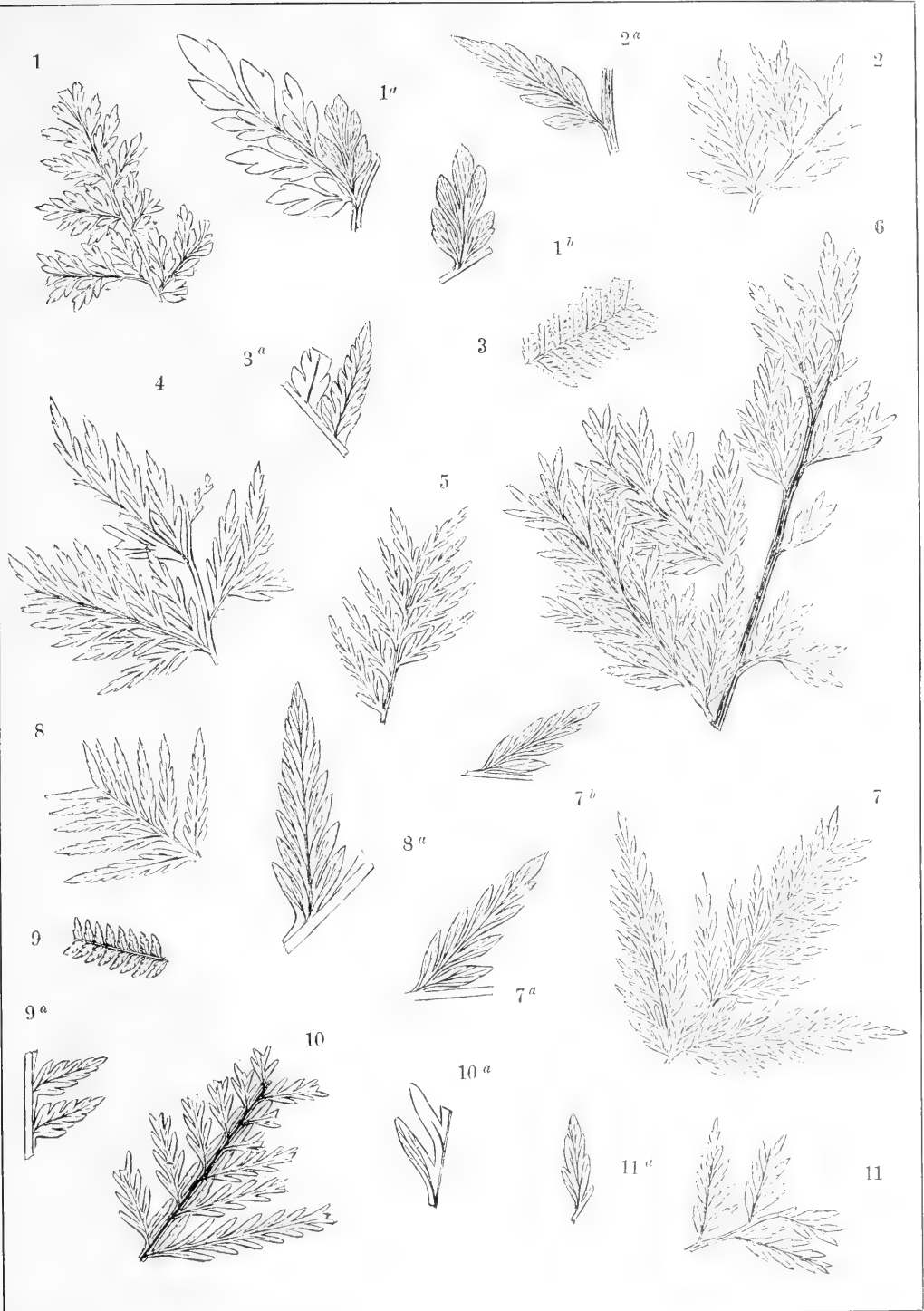

PLATE LV.

PLATE LV.

	Page.
FIG. 1. THYRSOPTERIS MEEKIANA, var. ANGUSTILOBA, sp. nov.	126
1. Summit of a compound pinna.....	126
1 ^a . Pinnule magnified.....	126
1 ^b . Upper pinna magnified.....	126
FIG. 2. THYRSOPTERIS ANGUSTIFOLIA, sp. nov.	131
2. Upper part of a compound pinna or of the frond.....	131
2 ^a . Lower pinnule magnified.....	131
FIG. 3. THYRSOPTERIS ANGUSTILOBA, sp. nov.	134
3. Portions of compound pinnae.....	134
3 ^a . Lower pinnule magnified.....	134
3 ^b . Upper pinnule magnified.....	134
FIG. 4. THYRSOPTERIS ELLIPTICA, sp. nov.	133
4. Summit of a compound pinna.....	133
FIG. 5. THYRSOPTERIS MICROLOBA, var. ALATA, sp. nov.	140
5. Upper part of a compound primary pinna or of the frond.....	140
5 ^a . Lower pinnule magnified.....	140
5 ^b . Upper pinna magnified.....	140
FIGS. 6, 7. THYRSOPTERIS BELLA, sp. nov.	139
6. Upper part of a primary pinna, or of the frond, slightly restored.....	139
6 ^a . Lower pinnule magnified.....	139
7. Upper part of an ultimate pinna.....	139
7 ^a . Several pinnules magnified.....	139



PLATE LVI.

PLATE LVI.

	Page.
FIGS. 1,3. <i>THYRSOPTERIS MEEKIANA</i> , var. <i>ANGUSTILOBA</i> , sp. nov.	136
1. Portions of compound pinnae	136
3. Upper part of a compound pinna	136
FIGS. 2,5. <i>THYRSOPTERIS BELLA</i> , sp. nov.	139
2. Summits of detached ultimate pinnae	139
2 ^a . Pinnule magnified	139
5. Fragments of a primary pinna or of the frond	139
FIGS. 4,8. <i>THYRSOPTERIS NANA</i> , sp. nov.	141
4. Small fragment of a compound pinna	141
8. Upper part of a compound pinna	141
8 ^a . Lower pinnule of a pinna, magnified	141
8 ^b . Pinnule from the middle of a pinna, magnified	141
8 ^c . Pinnule from the terminal portion of a pinna, magnified	141
FIGS. 6,7. <i>THYRSOPTERIS ELLIPTICA</i> , sp. nov.	133
6. Portion of the frond showing the stipe in part	133
6 ^a . Pinnule magnified, nerves not seen	133
7. Fragments of compound pinnae	133

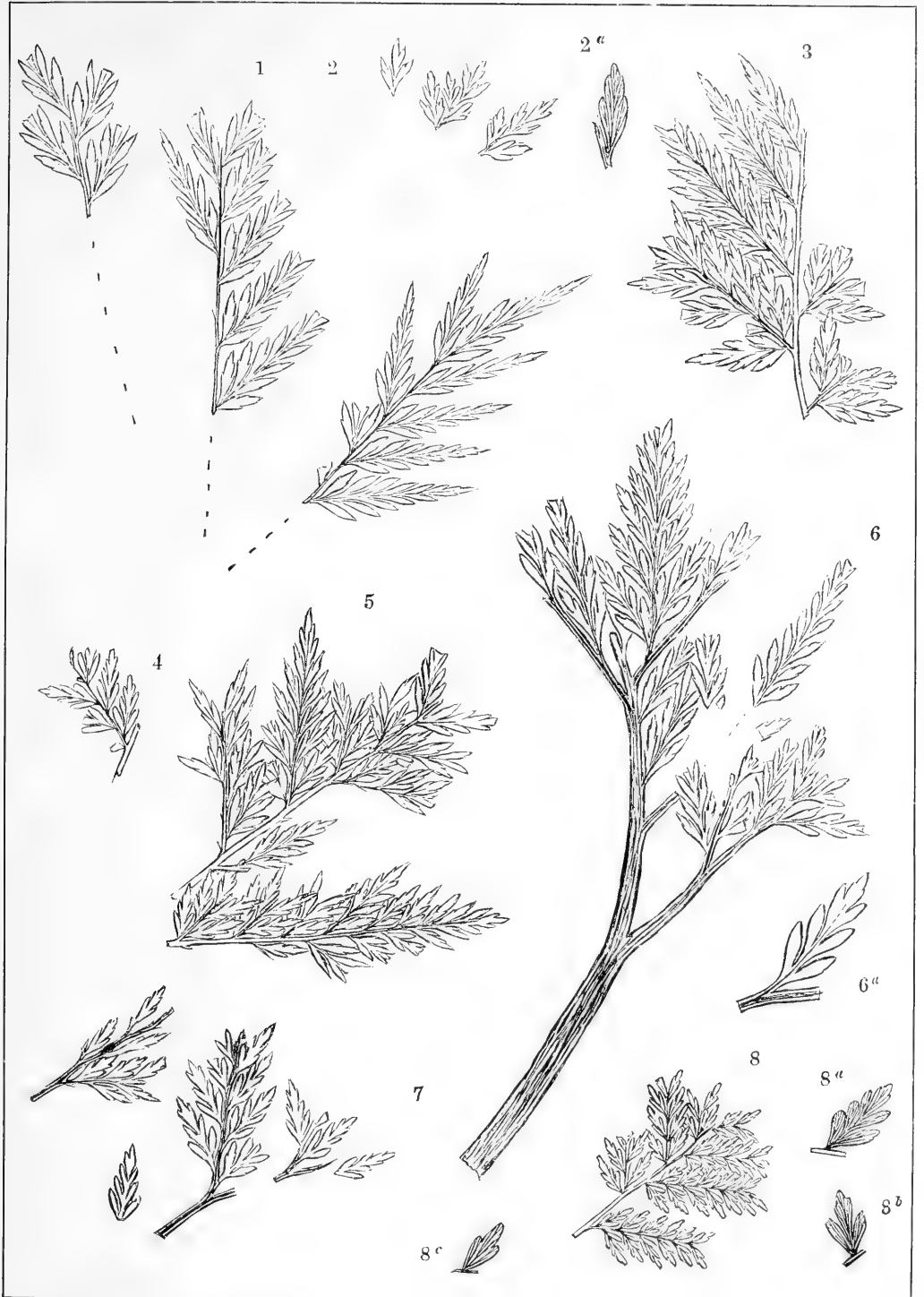

PLATE LVII.

PLATE LVII.

		Page.
FIGS. 1, 5.	THYRSOPTERIS BELLA, sp. nov.	139
	1. Fragments of a primary pinna or of the frond	139
	1 ^a . Ultimate upper pinna magnified, nerves not seen	139
	5. Fragments of a primary pinna or of the frond	139
	5 ^a . Upper pinna magnified	139
FIG.	2. THYRSOPTERIS VARIANS, sp. nov.	137
	2. Portion of a compound pinna	137
	2 ^a . Pinnule magnified, nerves not made out	137
FIG.	3, 8. THYRSOPTERIS INEQUIPINNATA, sp. nov.	142
	3. Terminal portion of a very long and slender ultimate pinna	142
	8. Upper part of a compound pinna	142
	8 ^a . Lower pinnule magnified	142
	8 ^b . Upper pinnule magnified	142
FIG.	4. THYRSOPTERIS MICROLOBA, sp. nov.	140
	4. Portion of a primary pinna or of the frond, slightly restored	140
	4 ^a . Ultimate pinna magnified	140
FIG.	6. THYRSOPTERIS ELLIPTICA, sp. nov.	133
	6. Portion of the upper part of a compound pinna	133
	6 ^a . Pinnule magnified	133
FIG.	7. THYRSOPTERIS PINNATIFIDA, sp. nov.	136
	7. Portion of a compound pinna	136
	7 ^a . Pinnule magnified	136



PLATE LVIII.

PLATE LVIII.

	Page.
FIG. 1. THYRSOPTERIS MICROLOBA, var. ALATA, sp. nov.	140
1. Upper part of a primary pinna or of the frond.	140
1 ^a . Pinnules magnified.	140
FIG. 2. THYRSOPTERIS ELLIPTICA, sp. nov.	133
2. Fragment of a compound pinna.	133
2 ^a . Pinnule magnified.	133
FIG. 3. THYRSOPTERIS HETEROPHYLLA, sp. nov.	142
3. Small fragment of the upper part of a compound pinna.	142
3 ^a . Ultimate pinna magnified.	142
FIG. 4. THYRSOPTERIS BELLA, sp. nov.	139
4. Portion of the upper part of a compound pinna.	139
4 ^a . Pinnule magnified, nerves not made out.	139
FIG. 5. SPHENOPTERIS THYRSOPTEROIDES, sp. nov.	89
5. Fragment of a compound pinna.	89
5 ^a . Pinna magnified.	89
FIG. 6. THYRSOPTERIS SPHENOPTEROIDES, sp. nov.	143
6. Portion of a compound pinna.	143
6 ^a . Lower pinnule magnified.	143
6 ^b . Upper pinnule magnified.	143
FIGS. 7, 10. THYRSOPTERIS OBTUSILOBA, sp. nov.	143
7. Portion of a compound pinna.	143
7 ^a . Pinnule from the lower part of a penultimate pinna.	143
7 ^b . Pinnule from the middle of 7.	143
7 ^c . Pinnule from the summit of 7, all magnified.	143
10. The summit of a compound pinna.	143
10 ^a . Ultimate pinna magnified.	143
FIG. 8. THYRSOPTERIS ANGUSTIFOLIA, sp. nov.	131
8. Portion of a compound pinna.	131
8 ^a . Pinna or a pinnule magnified.	131
FIG. 9. OSMUNDA DICKSONIODES, sp. nov.	146
9. Upper part of a compound pinna.	146
9 ^a . Pinnule magnified.	146

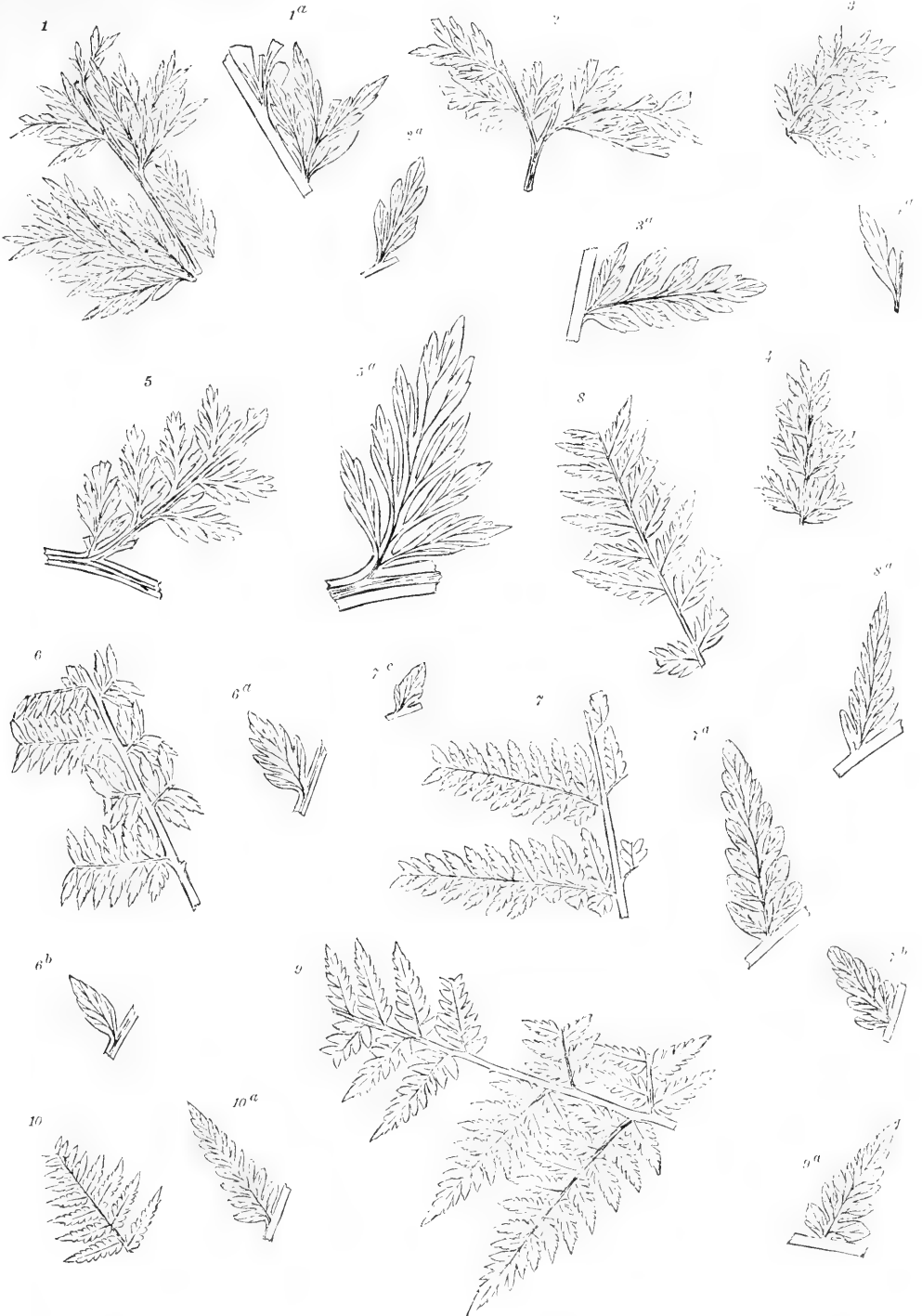

PLATE LIX.

PLATE LIX.

		Page.
FIGS. 1, 4, 8, 9, 11.	OSMUNDA DICKSONIOIDES, sp. nov.	146
	1. Upper part of an ultimate pinna	146
	1 ^a . Pinnule magnified	146
	4. Upper part of a compound pinna	146
	4 ^a . Pinnule magnified	146
	8. Fragment of a compound pinna	146
	8 ^a . Ultimate pinna magnified	146
	9. Portion of a compound pinna	146
	9 ^a . Ultimate pinna magnified	146
	11. Summit of a penultimate pinna	146
	11 ^a . Ultimate pinna magnified	146
	FIGS.	2, 12. ASPIDIUM MICROCARPUM, sp. nov.
2. Portion of a sterile compound pinna		103
2 ^a . Pinnules magnified		103
12. Summit of a fertile compound pinna		103
FIG.	3. THYRSOPTERIS SQUARROSA, sp. nov.	143
	3. Fragment of a compound pinna	143
	3 ^a . Pinnules magnified	143
	5. Fern in circinate vernation	143
	6, 7. THYRSOPTERIS RHOMBILOBA, sp. nov.	144
FIGS.	6, 7. Fragments of compound pinna	144
	6 ^a . Magnified ultimate pinna of 6	144
	7 ^a . Lower pinnule of 7 magnified	144
	7 ^b . Upper pinnule of 7 magnified	144
	10. THYRSOPTERIS RETUSA, sp. nov.	144
FIG.	10. Portion of the frond	144
	10 ^a . Lower pinnule magnified	144
	10 ^b . Upper pinnule magnified	144
	10 ^c . Tip of an ultimate pinna magnified	144

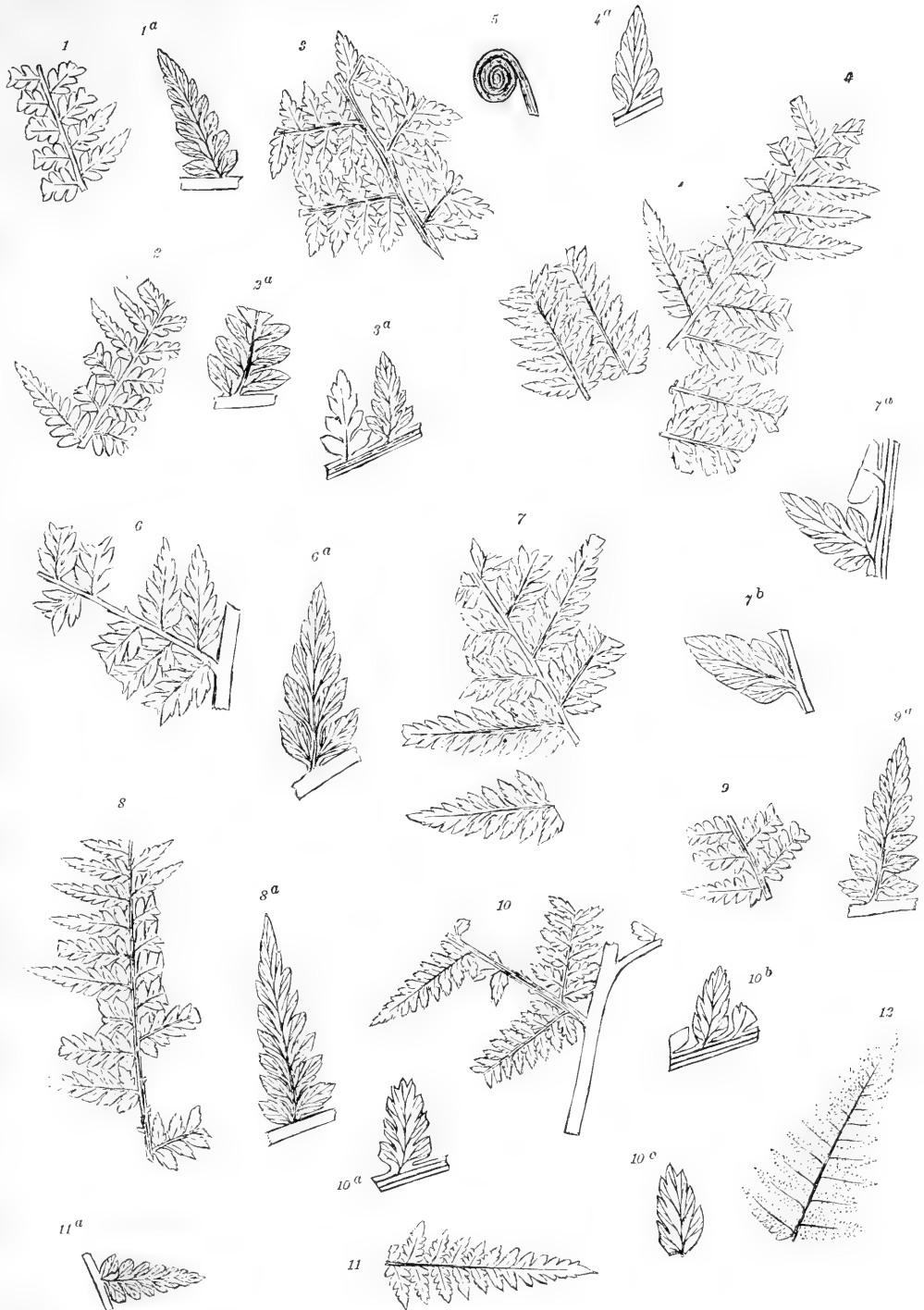

PLATE LX.

PLATE LX.

	Page.
FIGS. 1, 3. <i>OSMUNDA DICKSONIODES</i> , var. <i>LATIPENNIS</i> , sp. nov	147
1. Fragment of a large primary pinna or of the frond	147
1 ^a . Pinnule magnified	147
3. Upper part of a compound pinna	147
3 ^a . Ultimate pinna magnified	147
FIGS. 2, 4, 5, 9. <i>OSMUNDA DICKSONIODES</i> , sp. nov	146
2. Upper part of a compound pinna	146
2 ^a . Ultimate pinna magnified	146
4. Summit of a compound pinna	146
4 ^a . Pinna or pinnule magnified	146
5. Summit of a fertile compound pinna	146
5 ^a . Pinnule magnified	146
9. Portion of a compound pinna	146
9 ^a . Ultimate pinna magnified	146
9 ^b . Tip of an ultimate pinna magnified	146
FIGS. 6, 7. <i>ASPIDIUM MICROCARPUM</i> , sp. nov	103
6. Portion of a compound pinna, showing mixed sterile and fertile pinnules	103
6 ^a . Fertile pinnules magnified	103
6 ^b . Sterile and fertile pinnules magnified	103
7. Portion of a fertile compound pinna, showing the outline of the pinnules only in the arrangement of the sori	103
FIG. 8. <i>THYRSOPTERIS RHOMBILOBA</i> , sp. nov	144
8. Small fragment of a compound pinna	144
8 ^a . Pinna or pinnules magnified	144

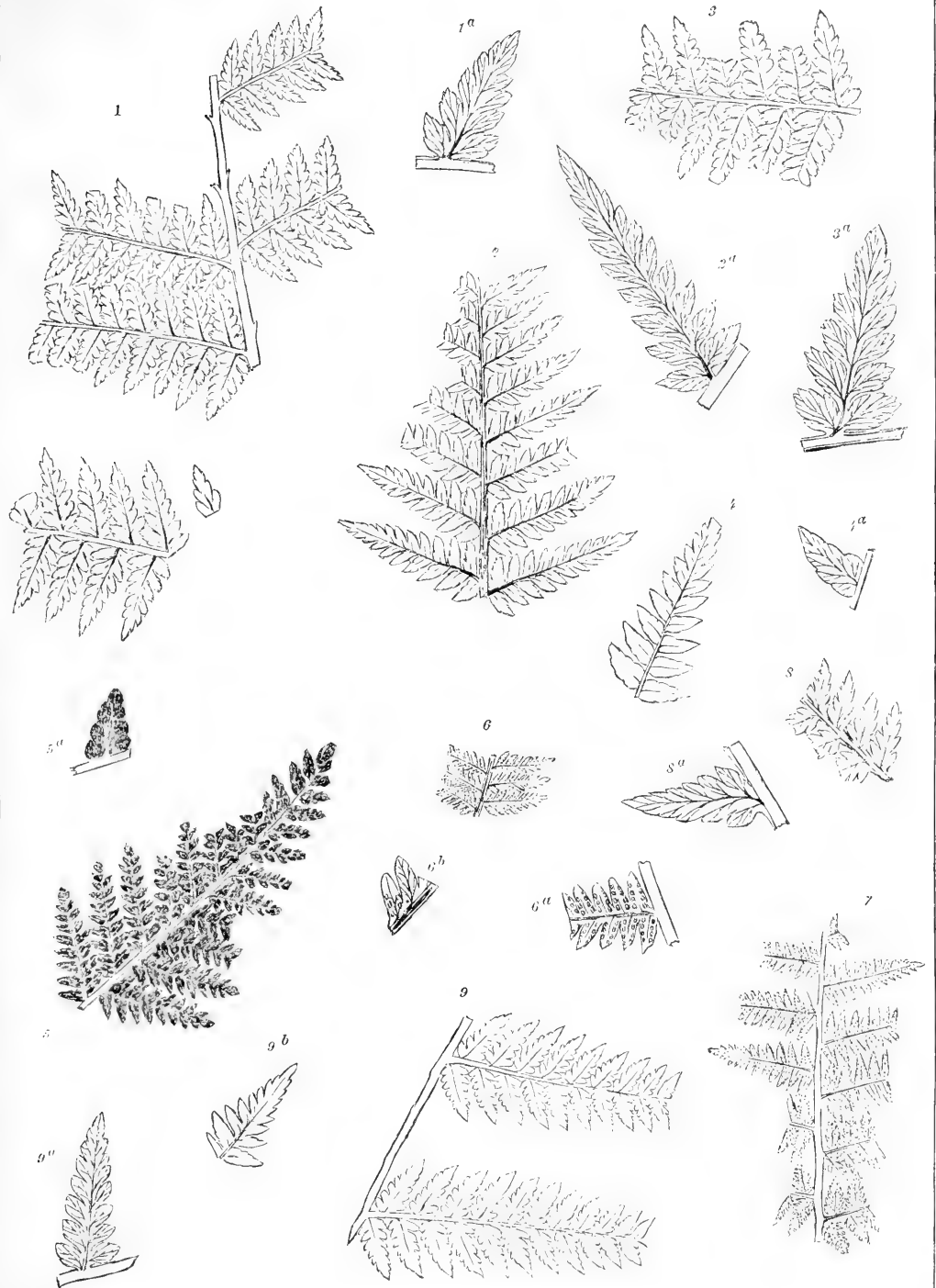

PLATE LXI.

P L A T E L X I .

	Page.
FIGS. 1, 2. <i>OSMUNDA DICKSONIOIDES</i> , sp. nov	146
1. Upper part of a compound pinna	146
1 ^a . Lower pinnule magnified	146
1 ^b . Upper pinnule magnified	146
2. Upper part of a compound pinna	146
2 ^a . Ultimate pinna magnified	146
FIG. 3. <i>OSMUNDA DICKSONIOIDES</i> , var. <i>LATIPENNIS</i> , sp. nov.	147
3. Upper portion of a compound pinna	147
3 ^a . Lower pinnules or lobes magnified	147
3 ^b . Upper ultimate pinna magnified	147
FIGS. 4, 5. <i>CTENOPTERIS INSIGNIS</i> , sp. nov	156
4. Portion of an ultimate pinna, with somewhat abnormal pinnules	156
4 ^a . Pinnule magnified	156
5. Tip of an ultimate pinna	156
FIG. 6. Undetermined plant	156
6 ^a . Portion magnified	156
FIG. 7. <i>ZAMIOPSIS PINNATIFIDA</i> , sp. nov	161
7. Portion of a compound pinna	161
FIG. 8. <i>ZAMIOPSIS LONGIPENNIS</i> , sp. nov.	164
8. Upper part of a pinnule	164

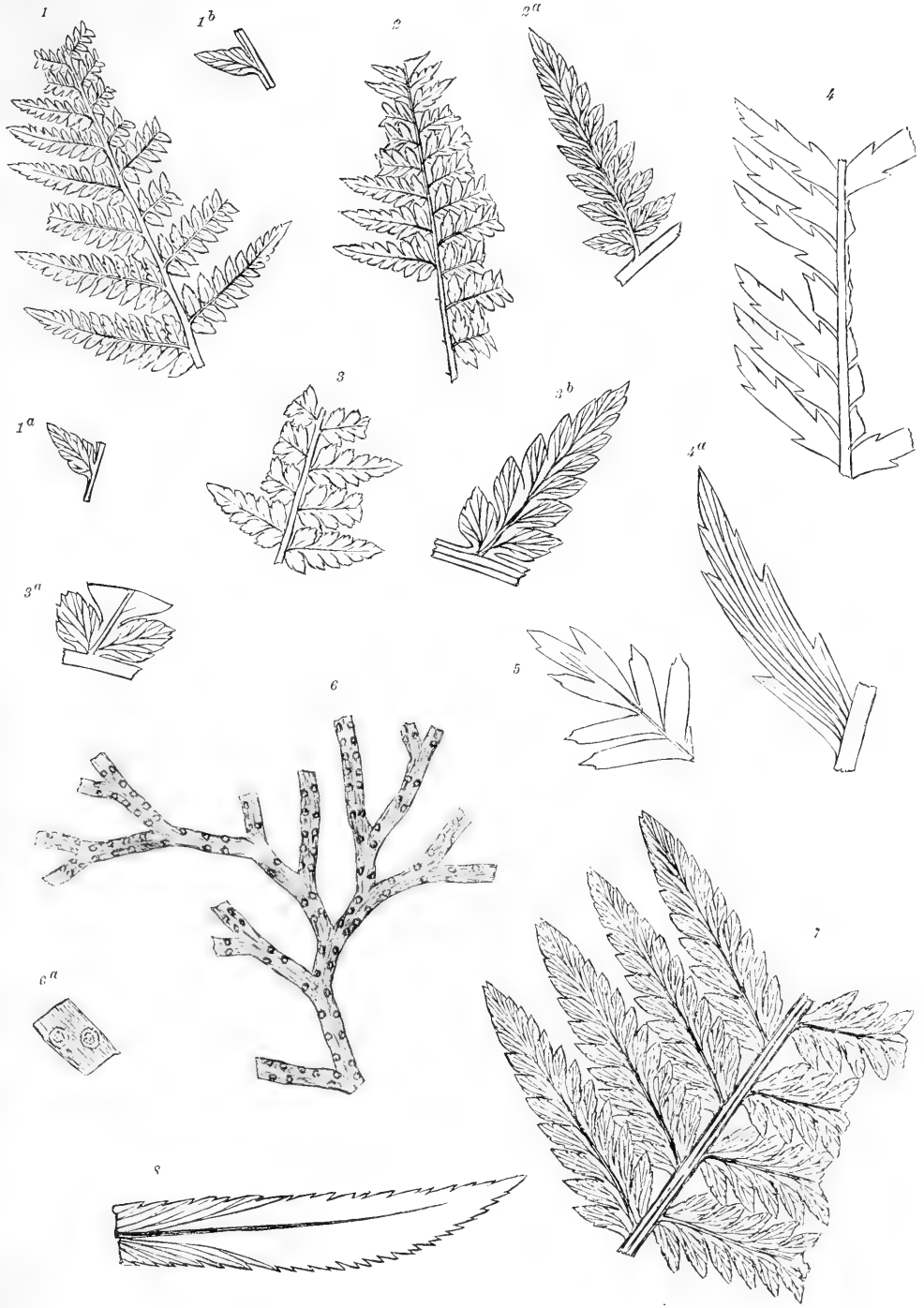

PLATE LXII.

PLATE LXII.

	Page.
FIG. 1. CTENOPTERIS INSIGNIS, sp. nov.	156
1. Portion of a large compound pinna or of the frond.	156
1 ^a . Pinnule magnified.	156
FIG. 2. CTENOPTERIS INTEGRIFOLIA, sp. nov.	158
2. Small fragment of an ultimate pinna.	158
FIG. 3. ZAMIOPSIS INSIGNIS, sp. nov.	162
3. Portion of an ultimate pinna.	162
FIG. 4. CTENOPTERIS VIRGINIENSIS, sp. nov.	157
4. Portions of two ultimate pinnae with unusually narrow pinnules.	157
4 ^a . Pinnule magnified.	157
FIG. 5. ZAMIOPSIS PINNATIFIDA, sp. nov.	161
5. Summit of a compound pinna.	161

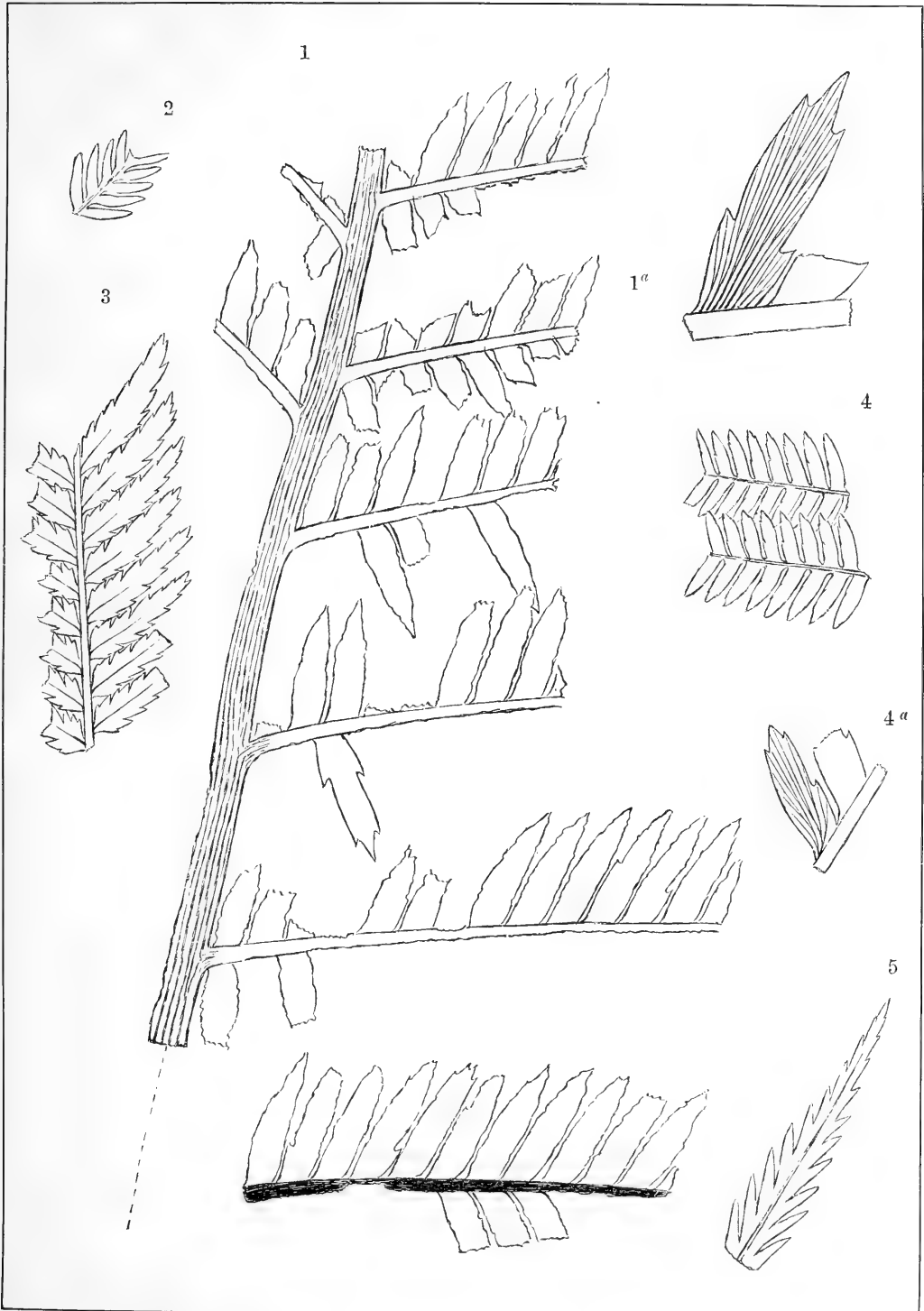

PLATE LXIII.

PLATE LXIII.

	Page.
FIGS. 1, 2. CTENOPTERIS INSIGNIS, sp. nov	156
1. Large fragment of a compound pinna partly restored.....	156
2. Fragment of an ultimate pinna	156
FIGS. 3, 4. SCLEROPTERIS DENTATA	153
3. Tip of an ultimate pinna.....	153
4. Portions of two ultimate pinna	153
4 ^a . Pinnule magnified.....	153

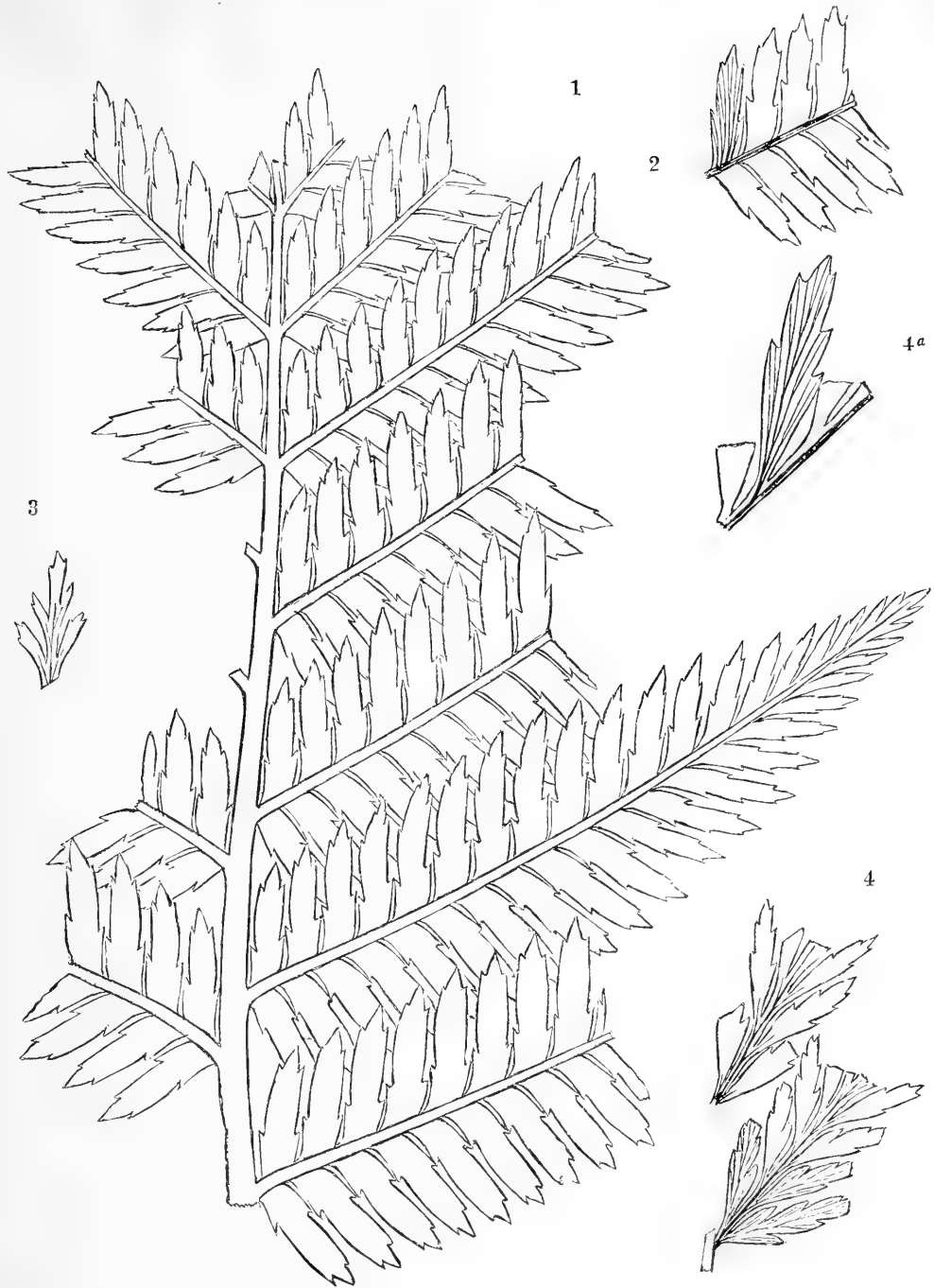

PLATE LXIV.

PLATE LXIV.

	Page.
FIGS. 1, 3. ZAMIOPSIS INSIGNIS, sp. nov	162
1. Portion of a large compound pinna or of the frond	162
1 ^a . Lower pinnule magnified	162
1 ^b . Upper pinnule magnified	162
3. Portion of a compound pinna slightly restored	162
FIG. 2. ZAMIOPSIS PINNATIFIDA, sp. nov	161
2. Portion of a compound pinna	161
2 ^a . Pinnules or lobes magnified	161

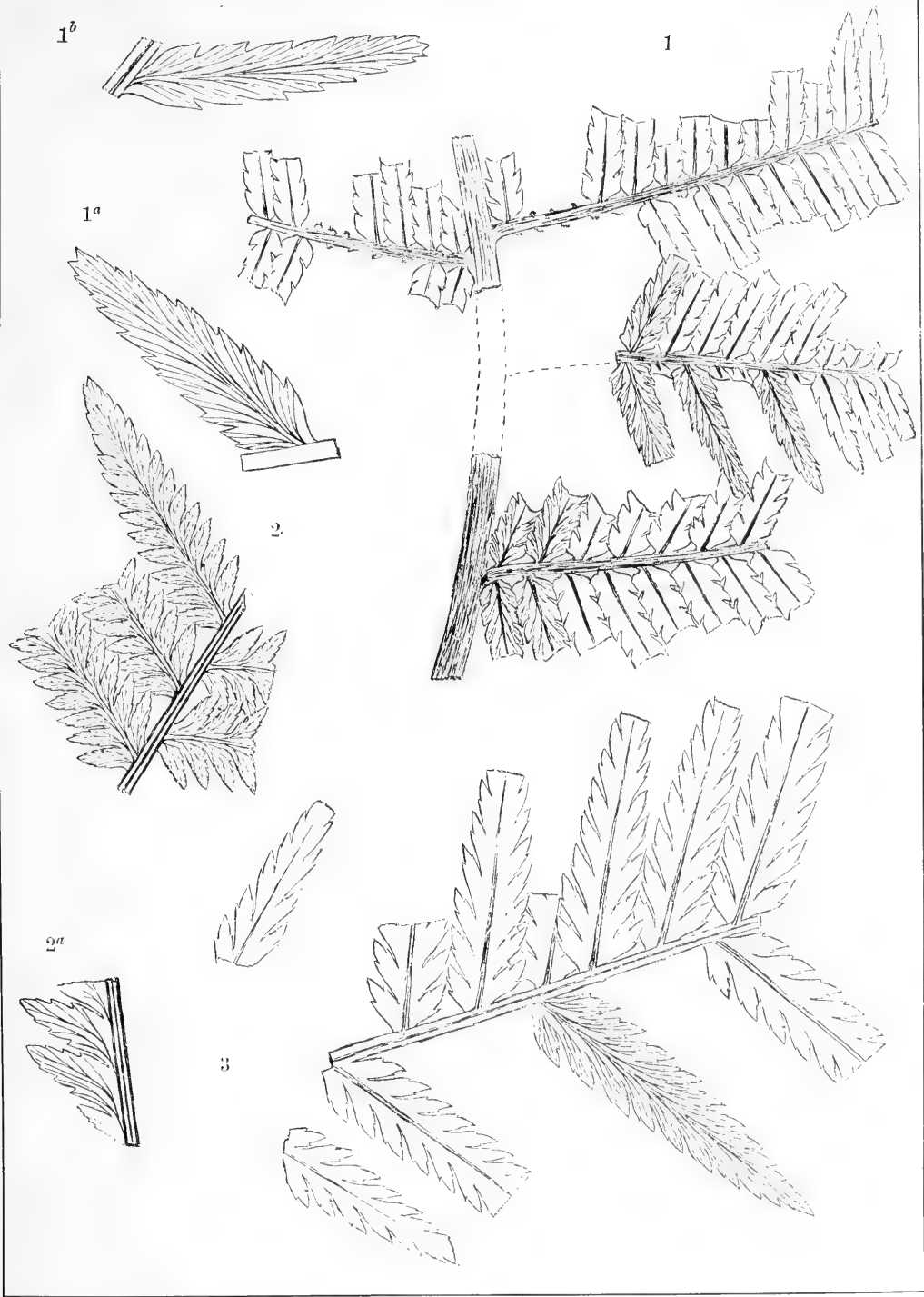

PLATE LXV.

P L A T E L X V .

		Page.
FIG.	1. CTENOPTERIS VIRGINIENSIS, sp. nov.	157
	1. Fragment of a compound pinna slightly restored	157
FIG.	2. CTENOPTERIS ANGUSTIFOLIA, sp. nov.	159
	2. Fragment of an ultimate pinna	159
	2 ^a . Pinnule magnified	159
FIG.	3. CTENOPTERIS INTEGRIFOLIA, sp. nov.	158
	3. Fragment of the upper part of a compound pinna	158
	3 ^a . Pinnule magnified	158
FIGS. 4-6.	ZAMIOPSIS INSIGNIS, sp. nov.	162
	4. Fragment of the upper part of a compound pinna slightly restored	162
	5. Fragment of the lower part of a compound pinna	162
	5 ^a . Pinnules enlarged	162
	6. Upper part of an ultimate pinna	162

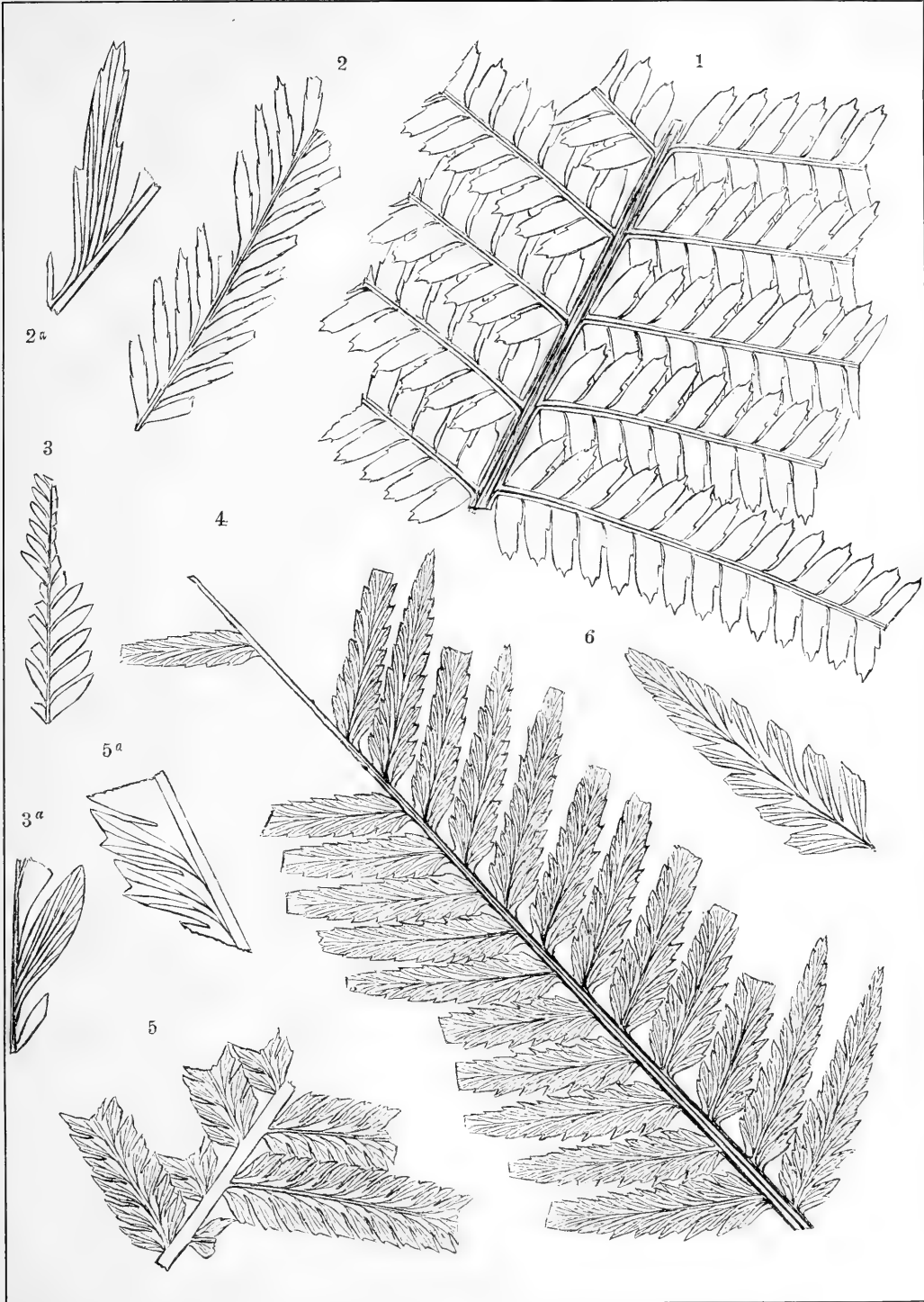

PLATE LXVI.

P L A T E L X V I .

		Page.
FIGS. 1, 5-8.	ZAMIOPSIS LACINIATA, sp. nov.	164
	1. Portion of a large primary pinna or of the frond	164
	1 ^a . Portion of a long pinnule magnified	164
	1 ^b . Short pinnule magnified	164
	5. Upper part of an ultimate pinna	164
	5 ^a . Pinnule magnified	164
	6. Upper part of an ultimate pinna	164
	7, 8. Two tips of ultimate pinnae	164
FIG.	2. ZAMIOPSIS INSIGNIS, sp. nov.	162
	2. Upper portion of an ultimate pinna	162
FIG.	3. ZAMIOPSIS PETIOLATA, sp. nov.	166
	3. Summit of an ultimate pinna	166
	3 ^a . Pinnule magnified	166
FIG.	4. CTENOPTERIS VIRGINIENSIS, sp. nov.	157
	4. Portion of a compound pinna	157

3

3^a

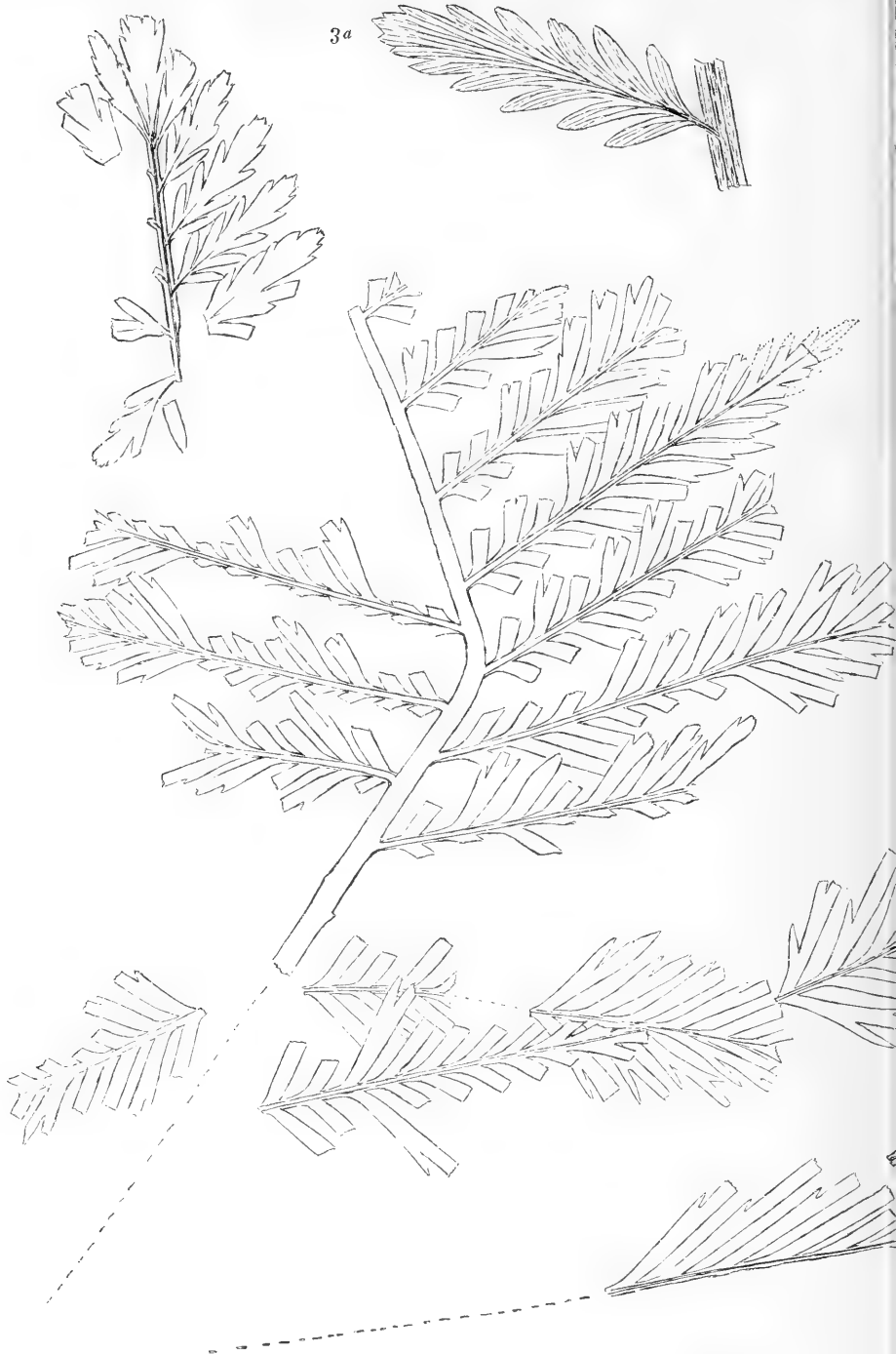

1

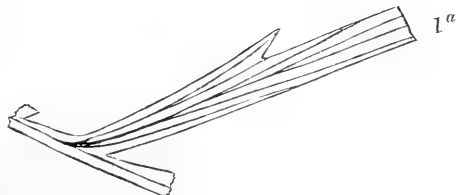
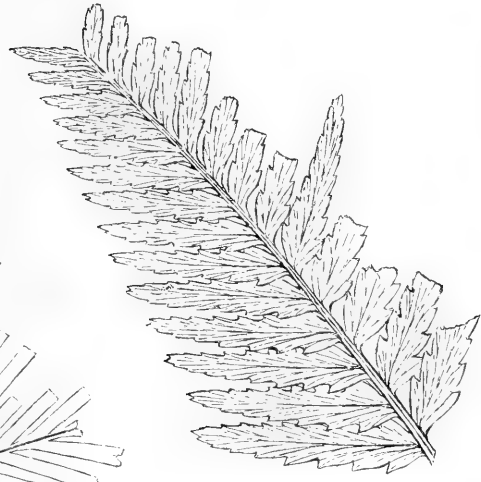
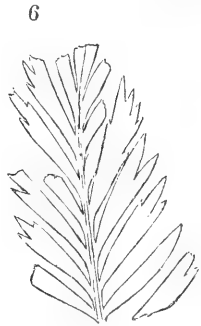
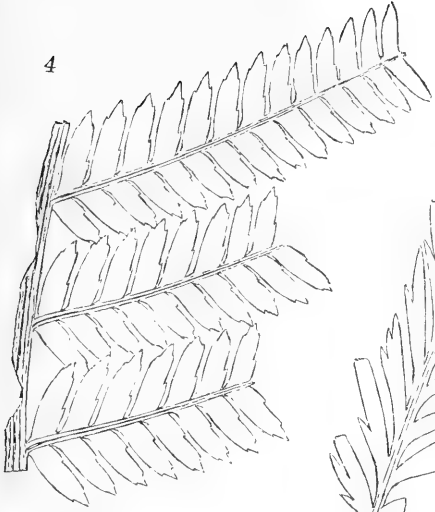



3



3^a

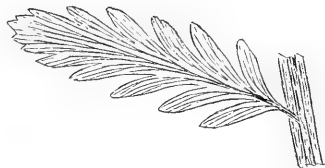

1

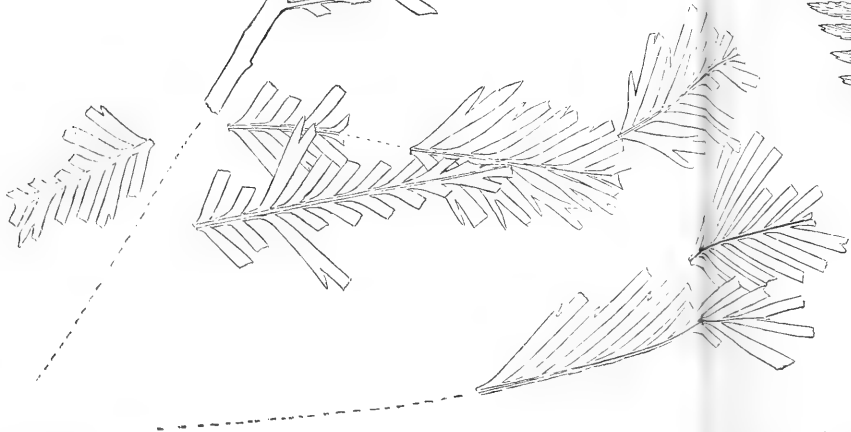

4

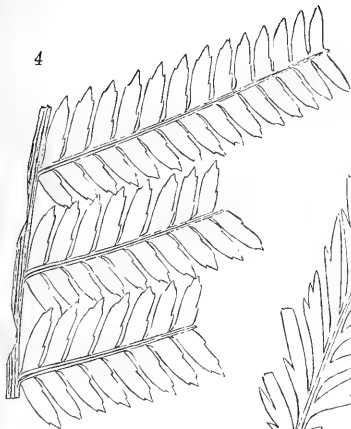

6



6

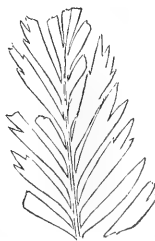

7



6^a

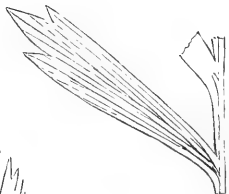

1^b

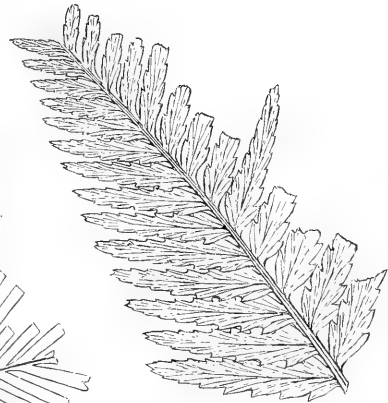

1^a

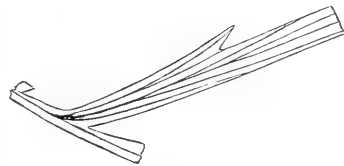

PLATE LXVII.

PLATE LXVII.

	Page.
FIG. 1. ZAMITES TENUINERVIS, sp. nov.	171
1. Basal portion of a leaflet of large size	171
FIG. 2. ZAMIOPSIS PINNATIFIDA, sp. nov.	161
2. Tip of a pinna?	161
FIG. 3. CTENOPTERIS MINOR, sp. nov.	157
3. Portion of a frond with pinnules fragmentary from maceration	157
3a-3c. Pinnules of 3 and of other fragments, magnified to show variation in teeth	157
FIG. 4. CTENOPTERIS ANGUSTIFOLIA, sp. nov.	159
4. Fragment of an ultimate pinna	159
4a. Pinnule magnified	159
FIG. 5. CTENOPTERIS LONGIFOLIA, sp. nov.	159
5. Fragment of an ultimate pinna	159
5a. Portion of a pinnule magnified	159
FIG. 6. DIOONITES BUCHIANUS, var. ANGUSTIFOLIUS, Schimper, sp.	185
6. Summit of a leaf with very remote leaflets	185
FIG. 7. ZAMIOPSIS INSIGNIS, sp. nov.	162
7. Fragment of a very large pinnule	162

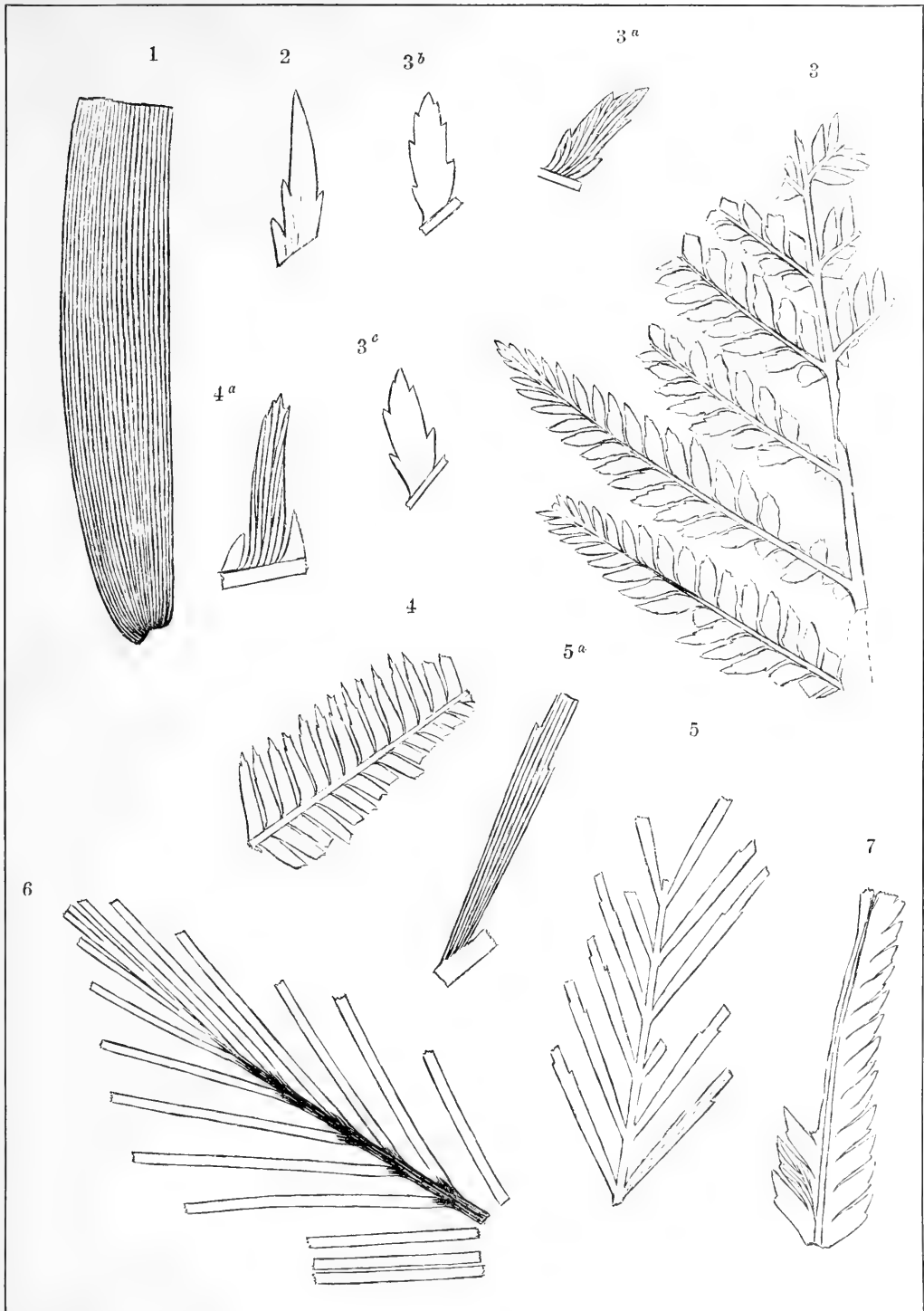
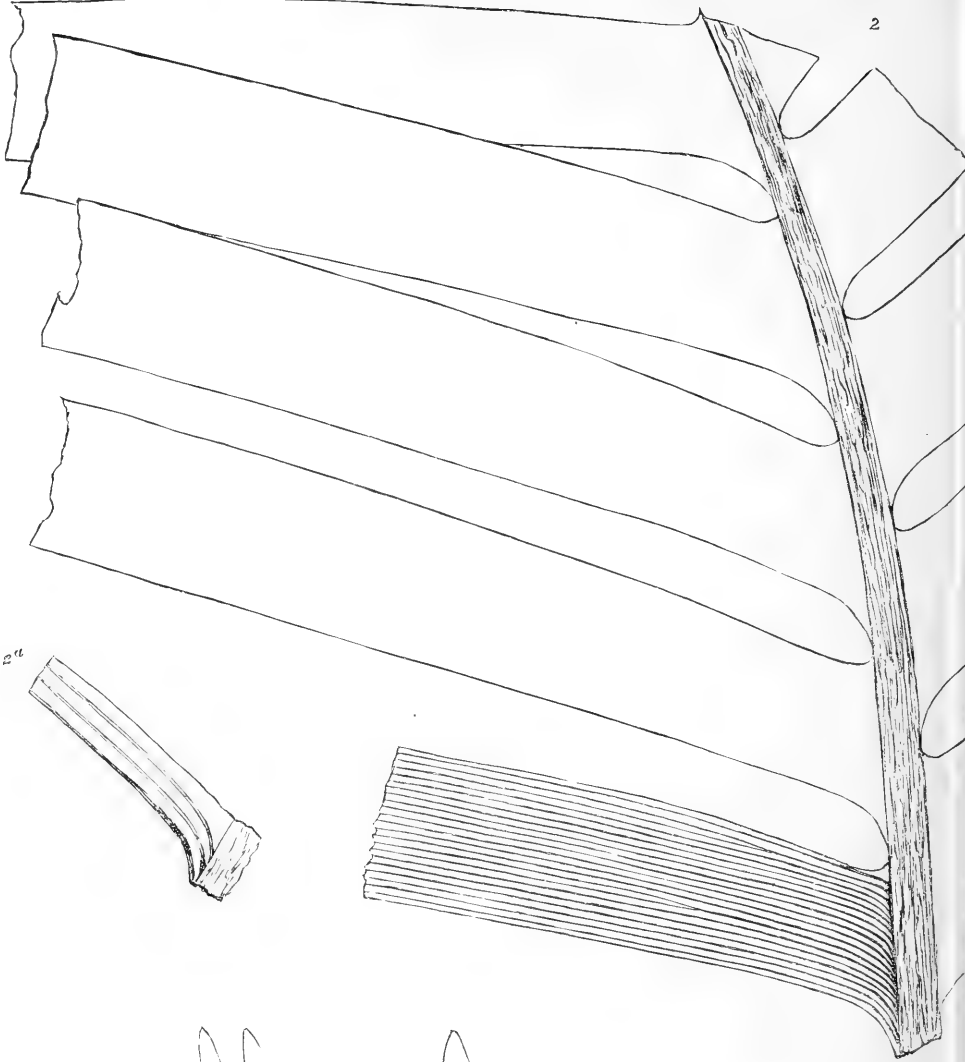

PLATE LXVIII.

PLATE LXVIII.

		Page.
FIG.	1. <i>DIOONITES BUCHANUS</i> Schimper	182
	1. Summit of a leaf	182
FIGS.	2, 3. <i>CTENOPHYLLUM LATIFOLIUM</i> , sp. nov.	175
	2. Portion of a leaf slightly restored	175
	2 ^a . Portion of a leaflet magnified to show the nerve-bundles	175
	3. Upper portion of a leaf corresponding to 2.	175
FIG.	4. <i>DIOONITES BUCHANUS</i> , var. <i>ANGUSTIFOLIUS</i> , Schimper, sp.	185
	4. Portion of the middle part of a leaf, showing the keeled midrib. The under surface is uppermost	185
FIG.	5. <i>GLOSSOZAMITES DISTANS</i> , sp. nov.	176
	5. Detached leaflets, and leaflets attached to the midrib	176
	5 ^a . Leaflet magnified	176
FIG.	6. <i>PODOZAMITES SUBFALCATUS</i>	179
	6. Leaflet showing a portion of the stem still attached	179



2'



5

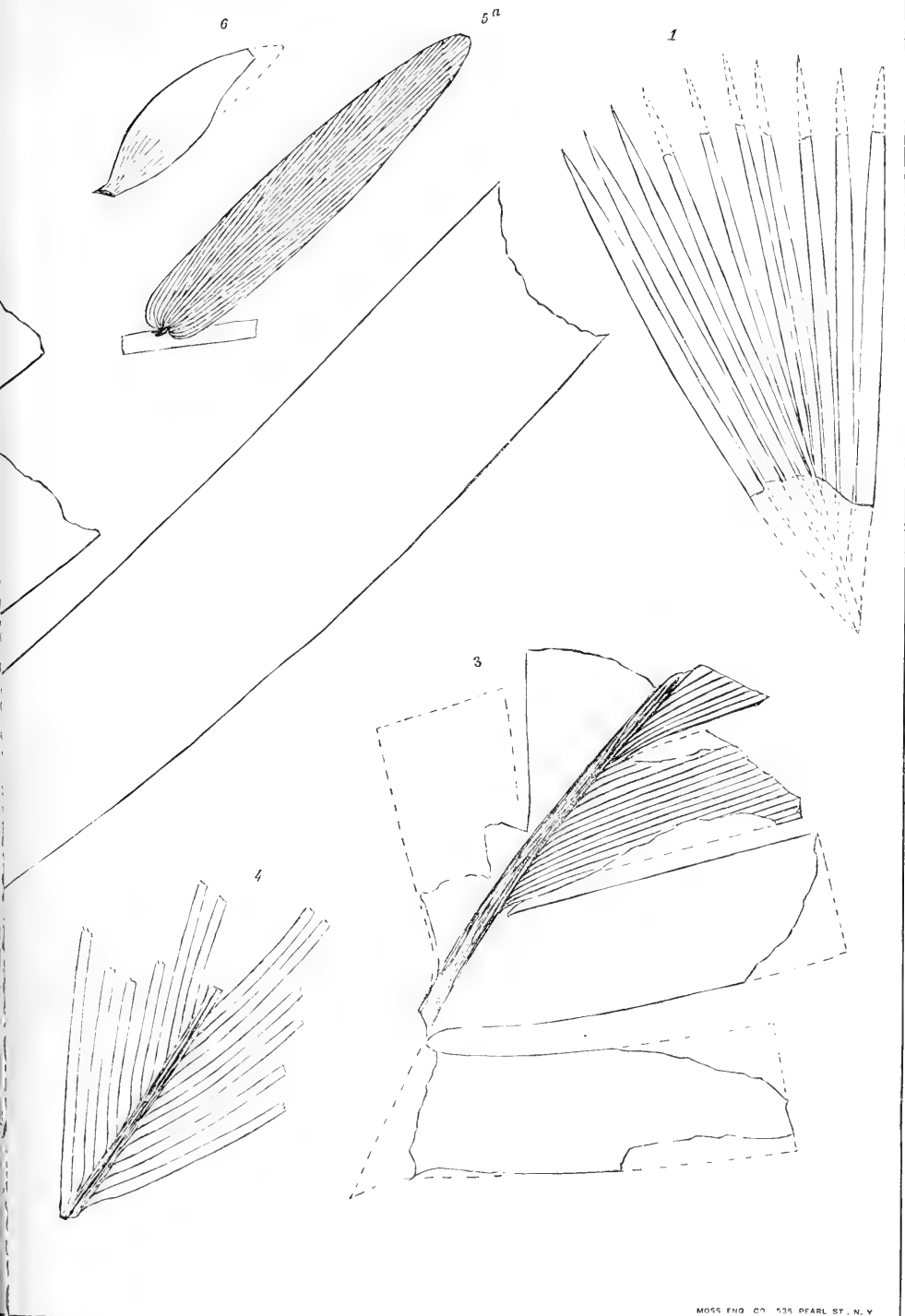



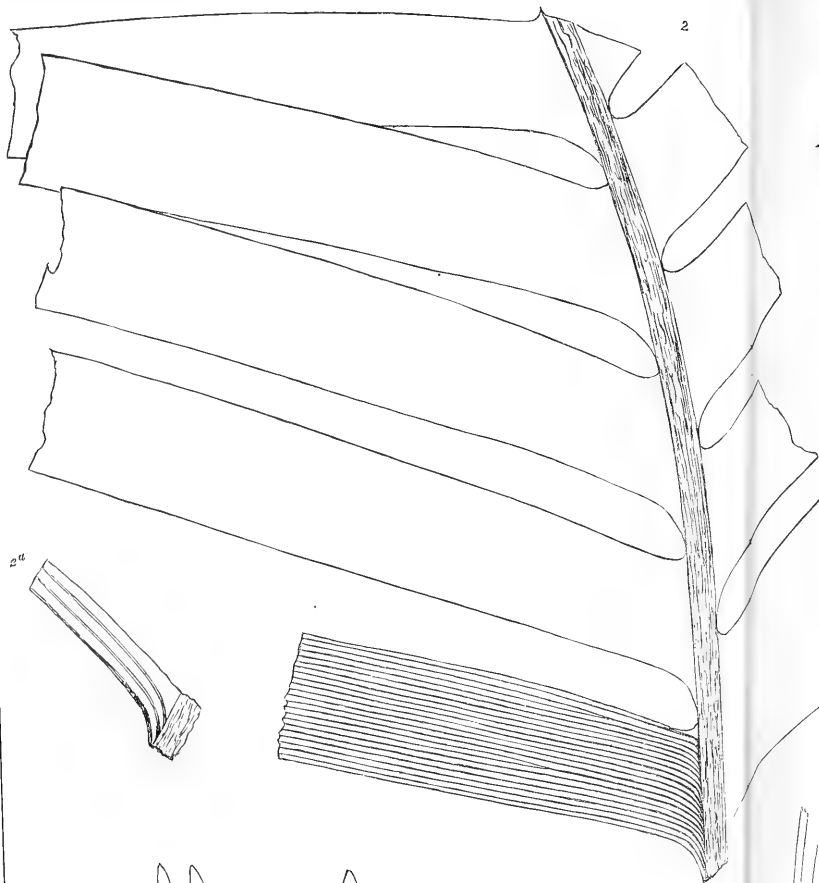

2

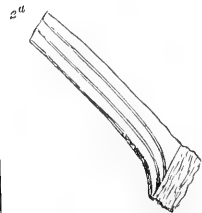

2^a

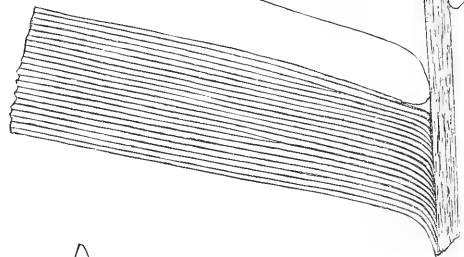

6

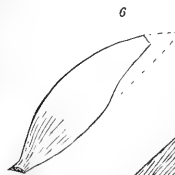

6

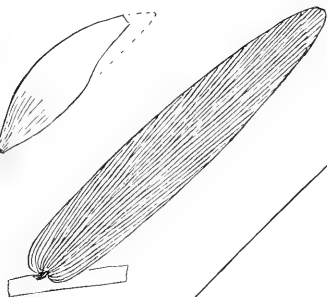

5^a

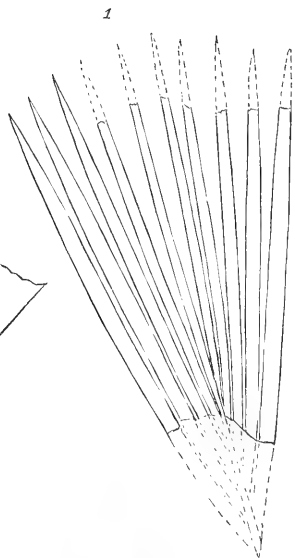

1

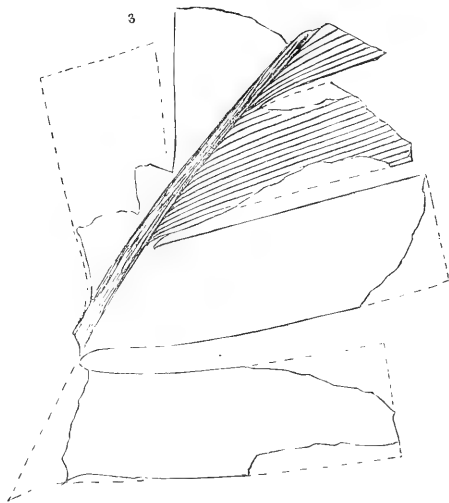

3

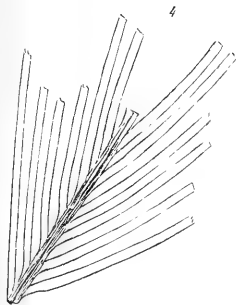

4

PLATE LXIX.

PLATE LXIX.

	Page.
FIGS. 1, 3. <i>DIOONITES BUCHANUS</i> Schimper	182
1. Fragment of a leaf with broad and short leaflets.....	182
3. Portion of a leaf showing the keeled midrib.....	182
FIG. 2. <i>ZAMITES TENUINERVIS</i> , sp. nov.	171
2. Basal portion of a normally shaped leaflet.....	171
FIG. 4. <i>ZAMITES CRASSINERVIS</i> , sp. nov.	172
4. Basal portion of a leaflet narrowed to the base	172

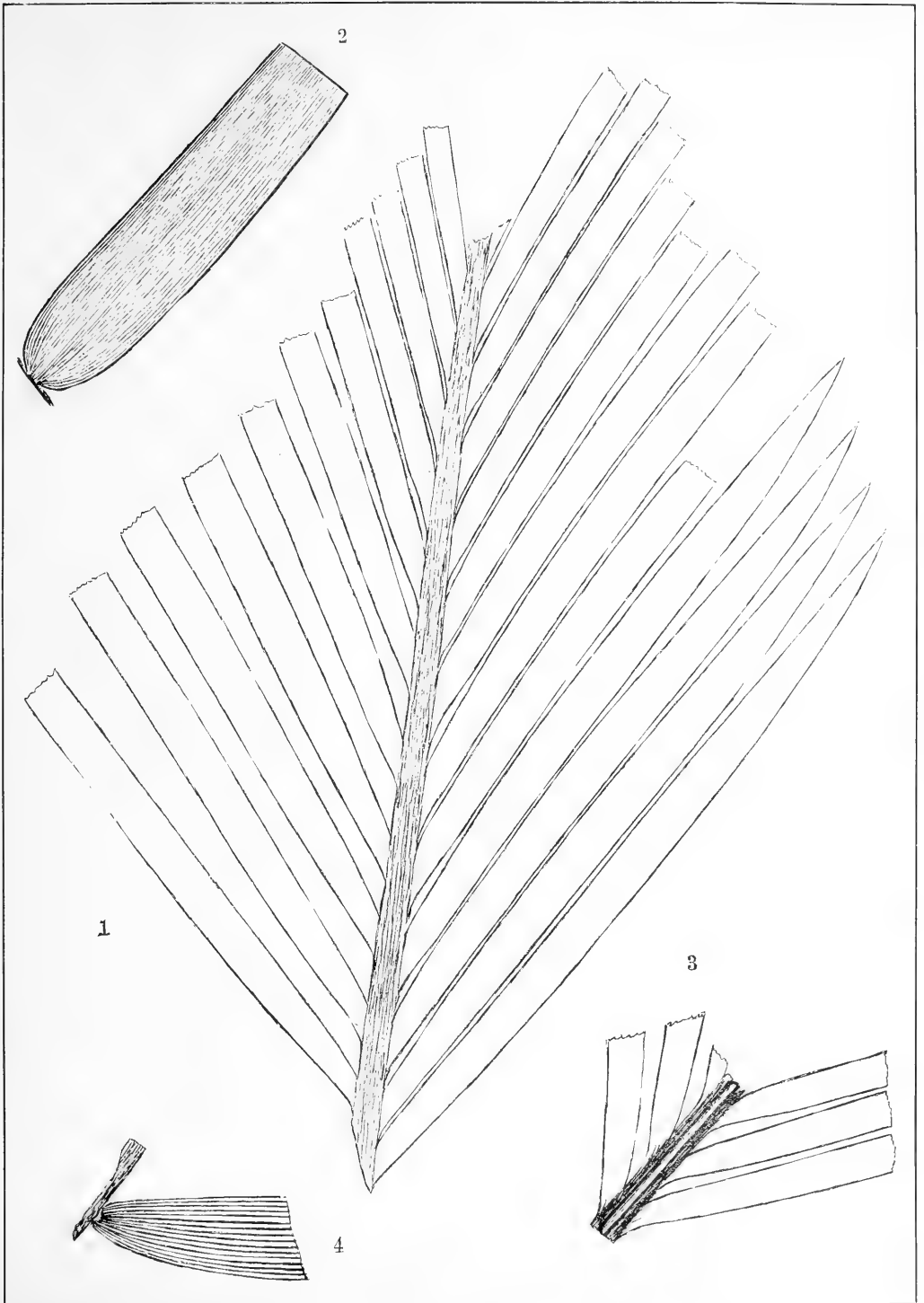



PLATE LXX.

PLATE LXX.

	Page.
FIG. 1. ZAMITES TENUINERVIS, sp. nov	171
1. Nearly complete leaflet	171
FIGS. 2, 3. DIOONITES BUCHANUS Schimper	182
2. Upper part of a leaf with narrow and very remote leaflets	182
3. Upper portion of a leaf with very remote leaflets of medium width	182
FIG. 4. ENCEPHALARTOPSIS NERVOSA, sp. nov	174
4. Portion of a small leaf.....	174

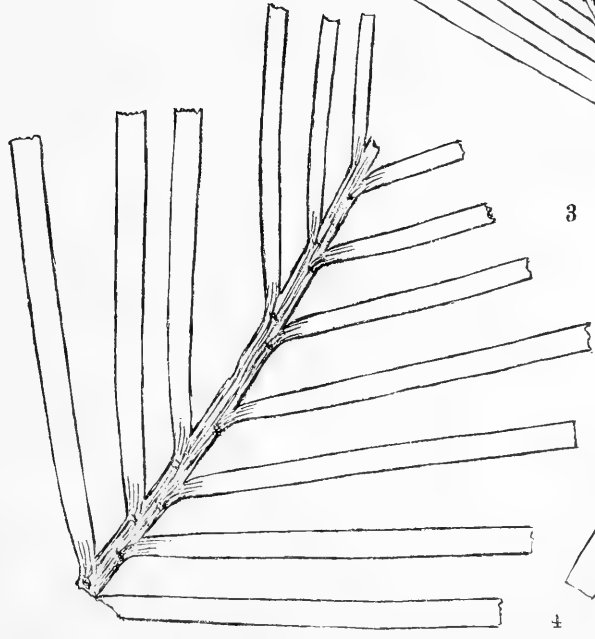
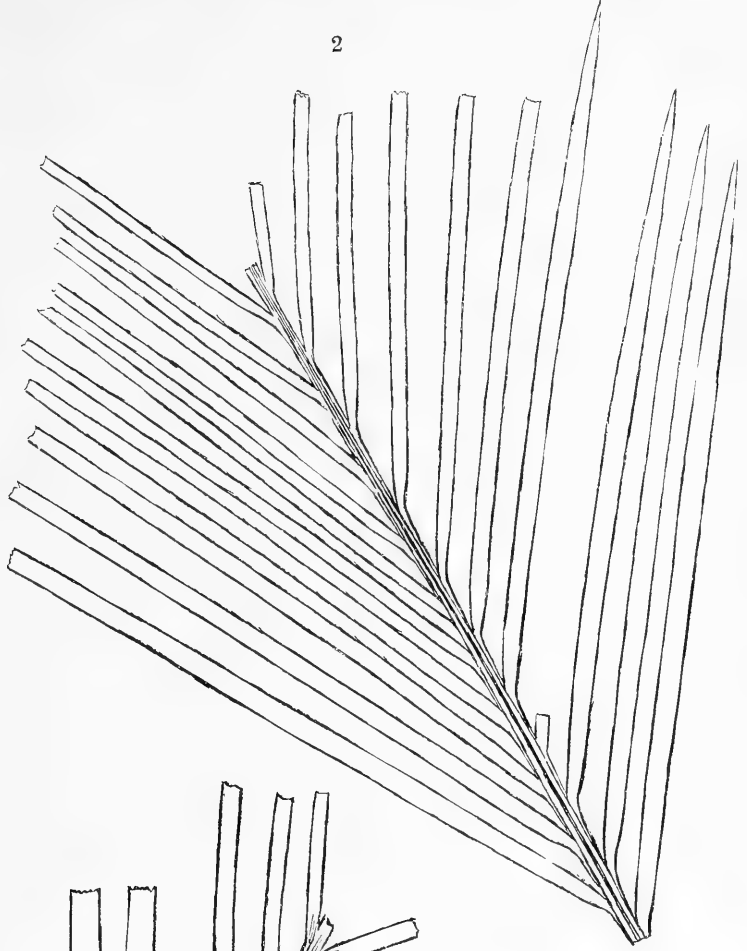



PLATE LXXI.

PLATE LXXI.

	Page.
FIG. 1. <i>DROONITES BUCHIANUS</i> Schimper.....	182
1. Portion of a leaf with fragments of leaflets that were at least 20 ^{cm} long. The entire entire length of some of the leaflets seen was not drawn	182
FIG. 2. <i>DROONITES BUCHIANUS</i> , var. <i>ANGUSTIFOLIUS</i> , Schimper	185
2. Summit of a leaf with closely placed leaflets.....	185
FIGS. 3, 4. <i>ENCEPHALARTOPSIS NERVOSA</i> , sp. nov.....	174
3. Portions of two leaflets apparently once attached to the same stem.....	174
4. Fragment of a leaflet showing a portion of one margin.....	174
4 ^a . Part of 4 magnified	174

3



1

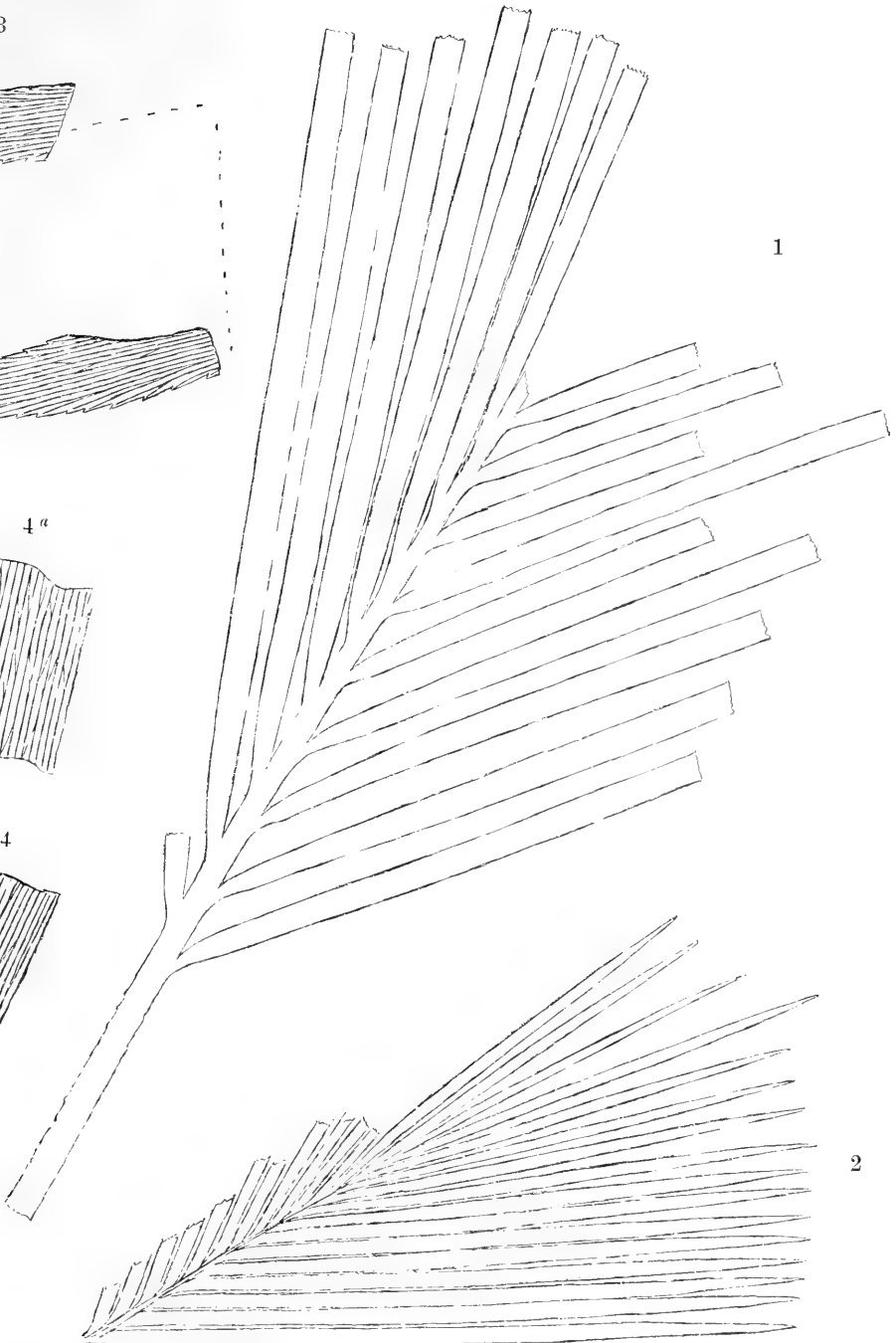

4''



4

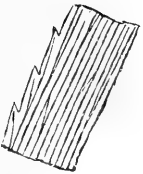

2

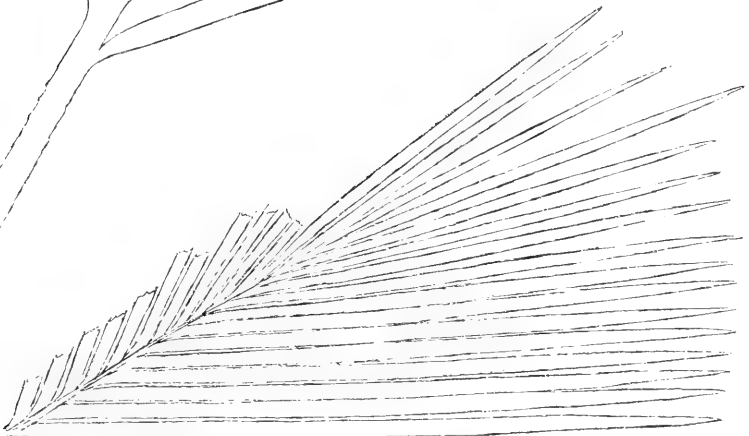



PLATE LXXII.

P L A T E L X X I I .

	Page.
FIGS. 1, 2. <i>DIOONITES BUCHIANUS</i> Schimper	182
1. Upper part of a leaf with remote and narrow leaflets	182
2. Summit of a leaf with remote leaflets	182
2 ^a . Basal portion of a leaflet, showing the insertion of the nerves magnified.....	182
2 ^b . Portion of 2 ^a still more magnified, to show the fine granulation between the nerves	182
FIGS. 3, 4. <i>ENCEPHALARTOPSIS NERVOSA</i> , sp. nov.	174
3. Upper portion of a leaf of medium size	174
4. Middle portion of a leaf of large size	174

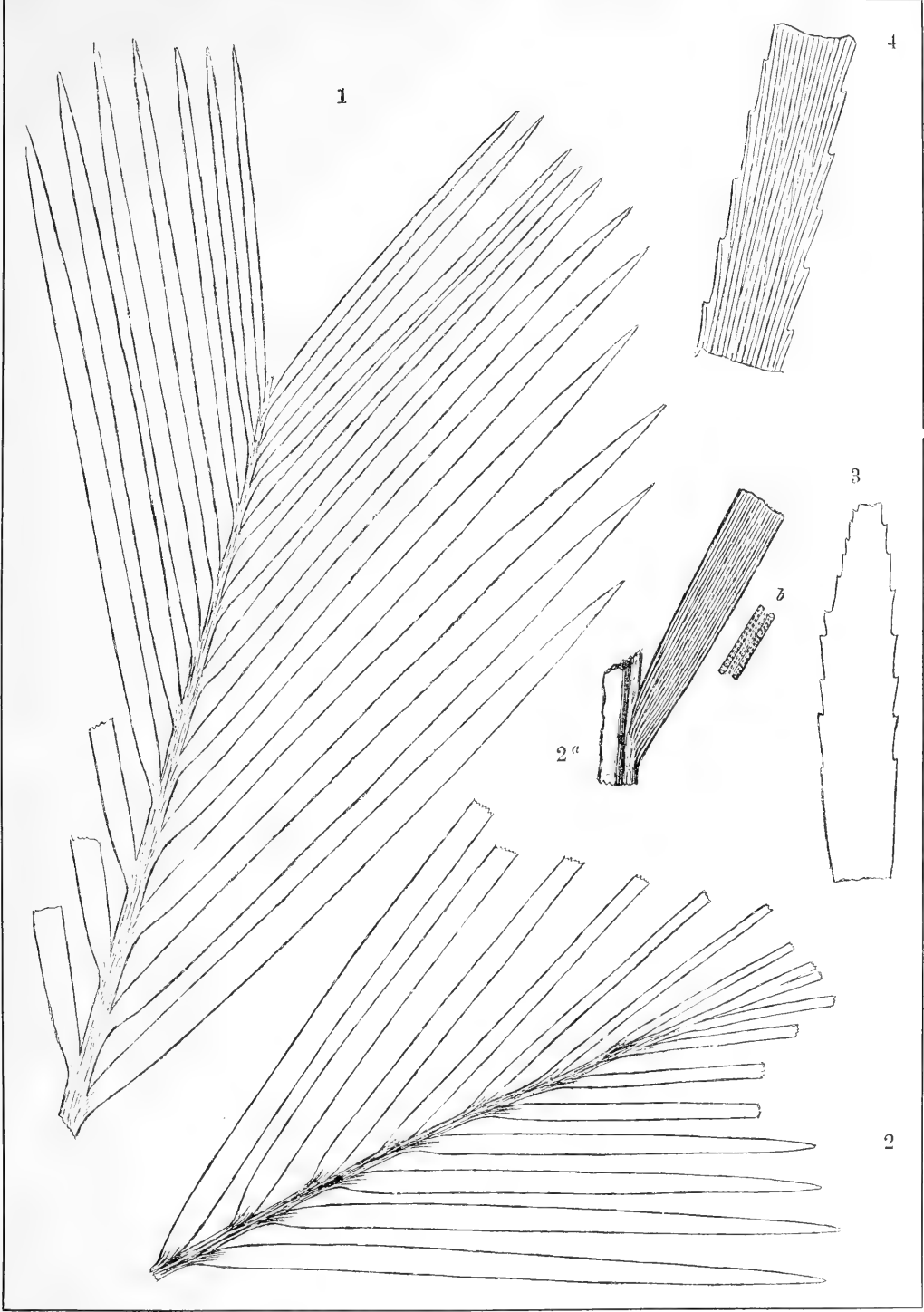
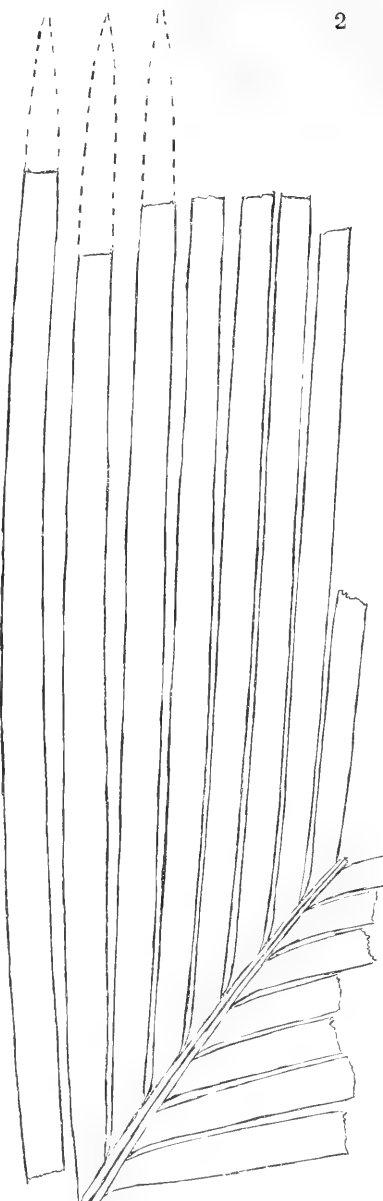

PLATE LXXIII.

PLATE LXXIII.

	Page.
FIGS. 1-3. <i>DIOONITES BUCHIANUS</i> Schimper.....	182
1. Summit of a leaf, showing the great narrowing of the terminal leaflets.....	182
2. Fragment of the middle part of a normal leaf	182
3. Fragment of the upper part of a very large leaf, showing the midrib much attenuated	182
3 ^a . Basal portion of a leaf magnified.....	182
3 ^b . Summit of a leaf magnified	182



2

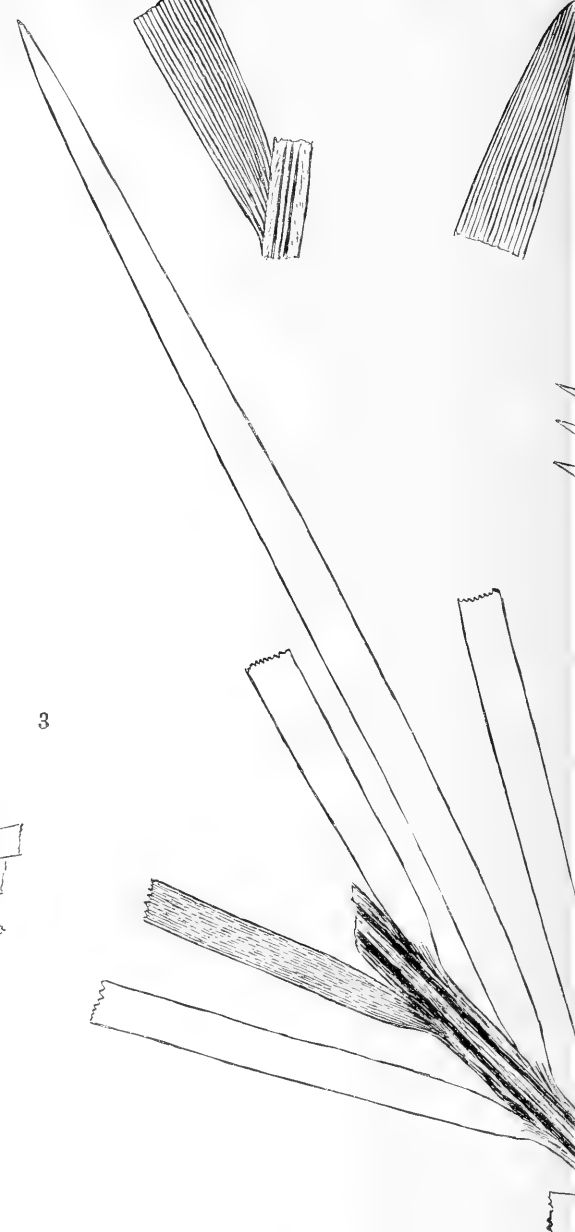

3

1

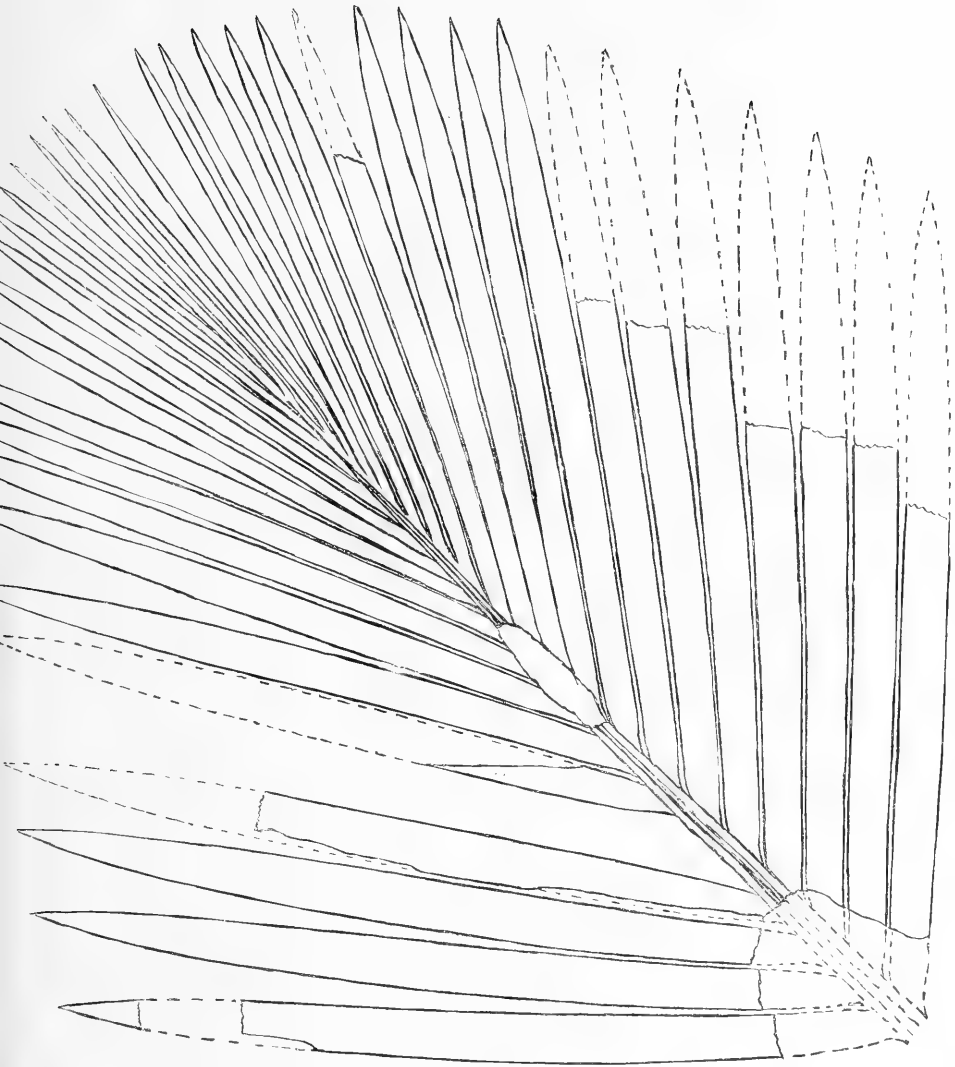



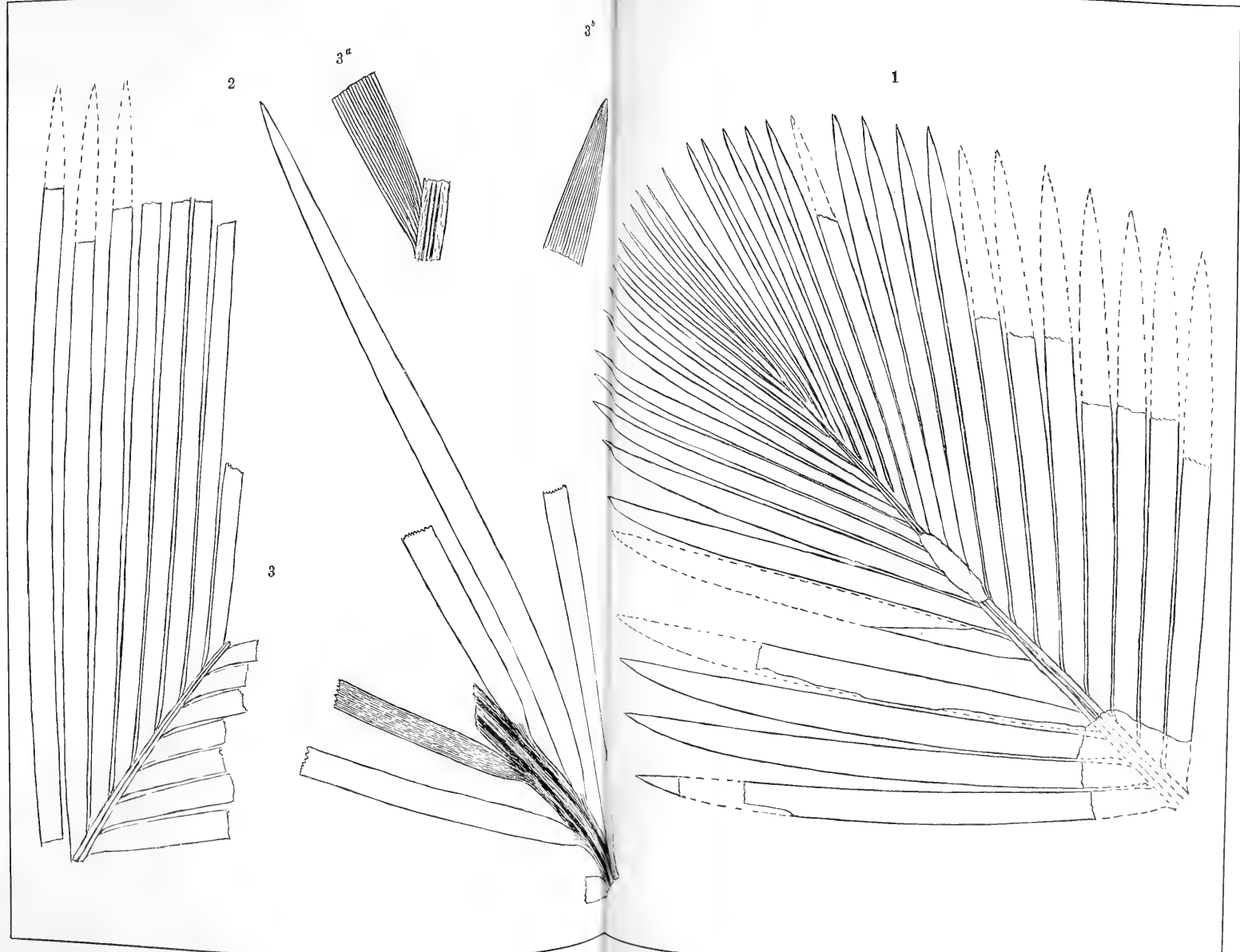
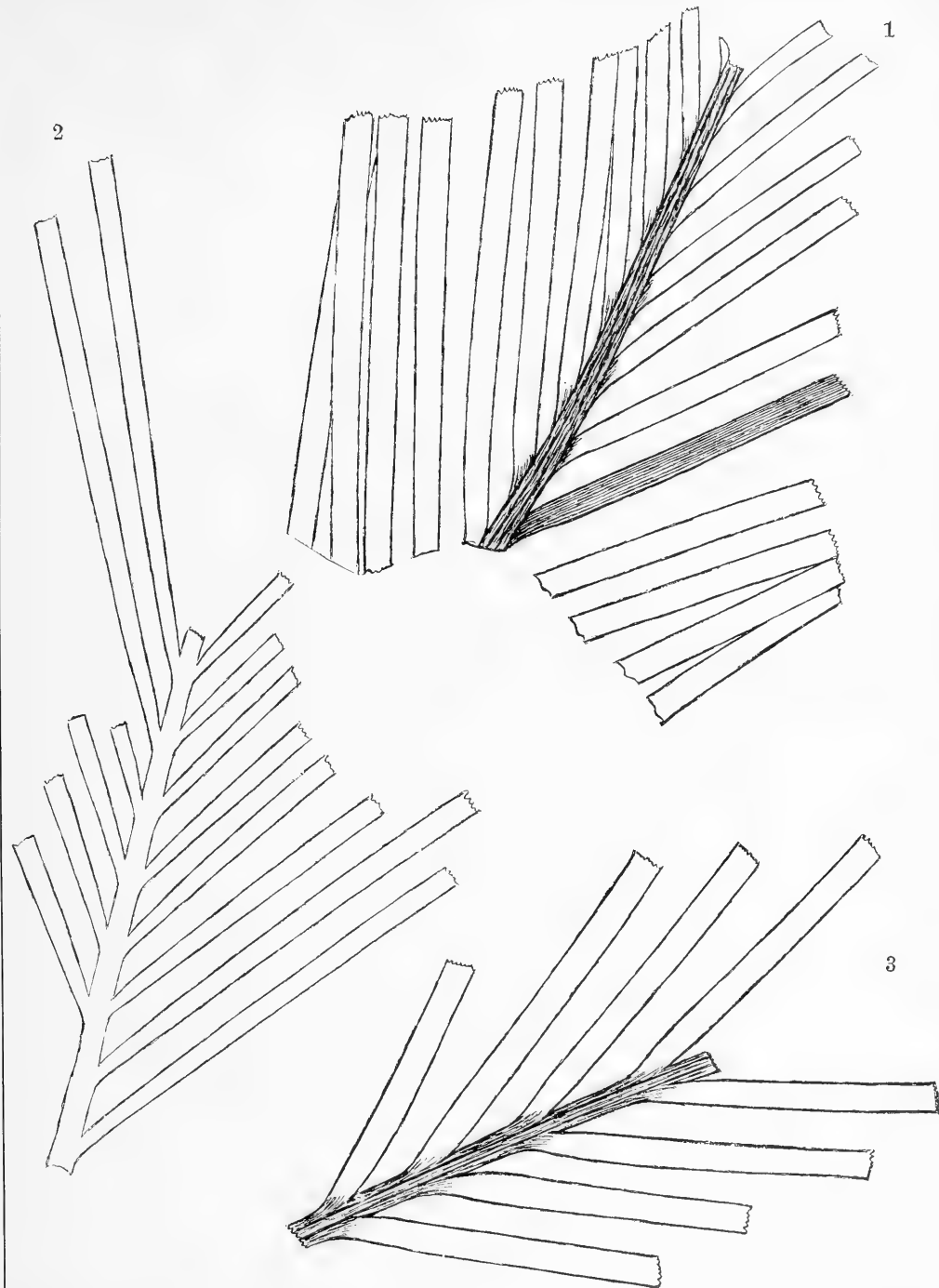



PLATE LXXIV.

PLATE LXXIV.

	Page.
Figs. 1-3. <i>Dioonites Buchananus</i> Schimper	182
1. Portion of a leaf with leaflets of normal width, showing the keeled midrib.....	182
2. Portion of a leaf, showing the leaflets gradually and considerably narrowed toward the base; a rather unusual feature	182
3. Portion of a leaf with keeled midrib, showing well the attachments of the leaflets, which are strictly opposite	182



2

1

3

PLATE LXXV.

PLATE LXXV.

	Page.
FIG. 1. NAGEIOPSIS LONGIFOLIA, sp. nov	195
1. Portion of a large branch slightly restored, and with the original shape and dimensions sions of the leaves indicated	195
1 ^a . Base of a leaf magnified	195
1 ^b . Summit of the same magnified	195
FIG. 2. NAGEIOPSIS RECURVATA, sp. nov	197
2. Fragment of a branch with small leaves	197
FIG. 3. ZAMITES TENUINERVIS, sp. nov	171
3. Lower portion of a large leaf	171

1^b

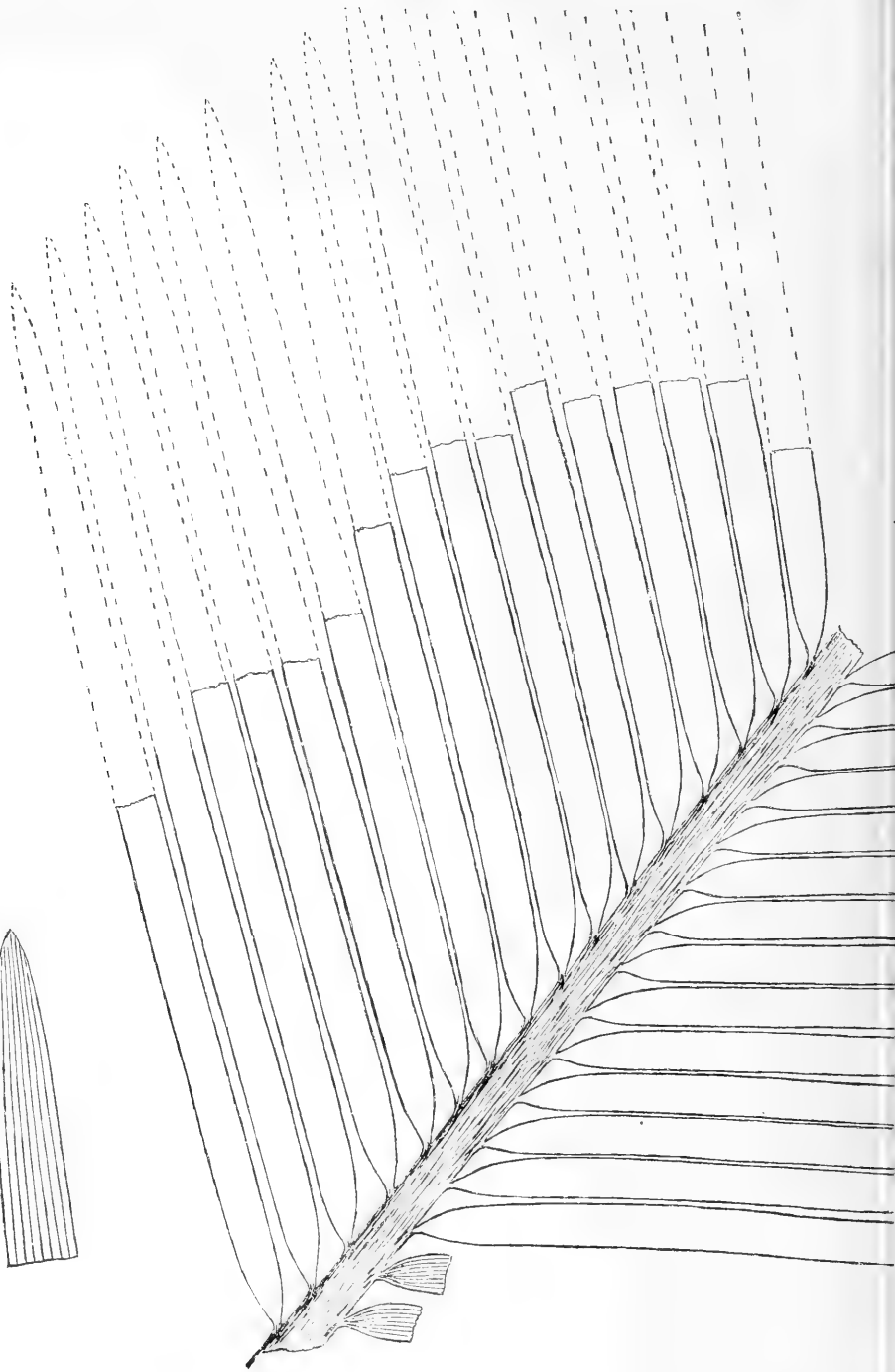

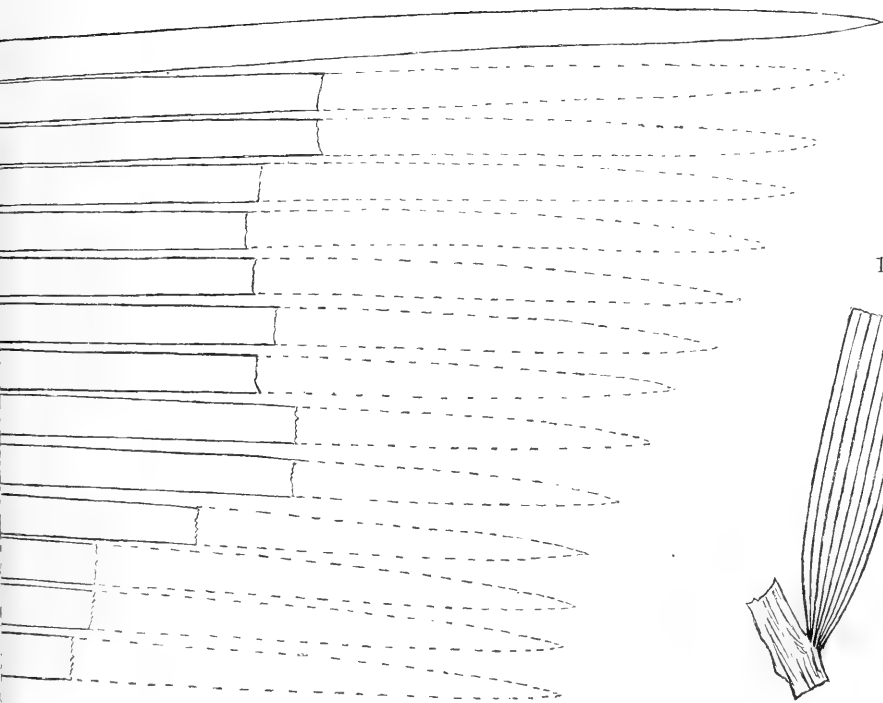
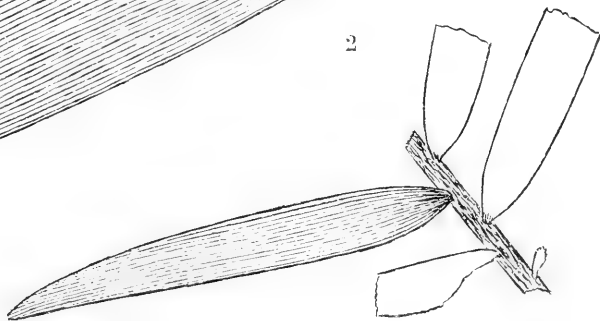
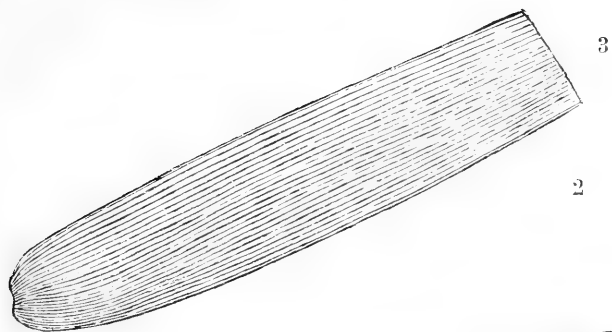

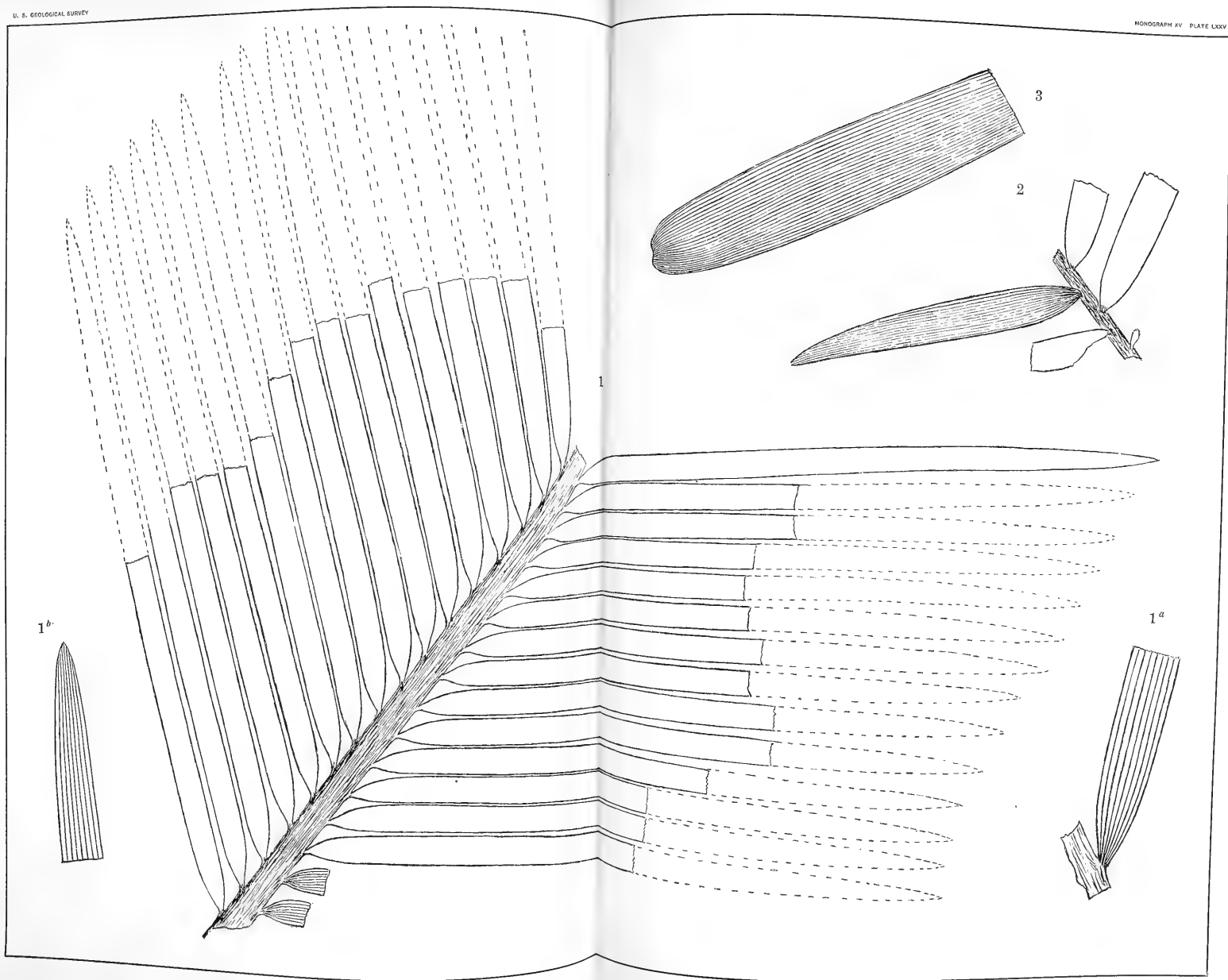



PLATE LXXVI.

PLATE LXXVI.

	Page.
FIG. 1. <i>PODOZAMITES PEDICELLATUS</i> , sp. nov.	180
1. Base of a large leaflet	180
FIGS. 2-6. <i>NAGEIOPSIS LONGIFOLIA</i> , sp. nov.	195
2. Portion of a stem with two large leaves	195
3. Portion of a large stem, showing near the top the former presence of two lateral branches	195
4. Fragment of a stem with leaves of the maximum width	195
5. Portion of a stem, showing near midway scars left by scales of a former terminal bud	195
6. Tip of a leaf	195
FIG. 7. <i>ZAMITES TENUINERVIS</i> , sp. nov.	171
7. Basal portion of a narrow leaf	171

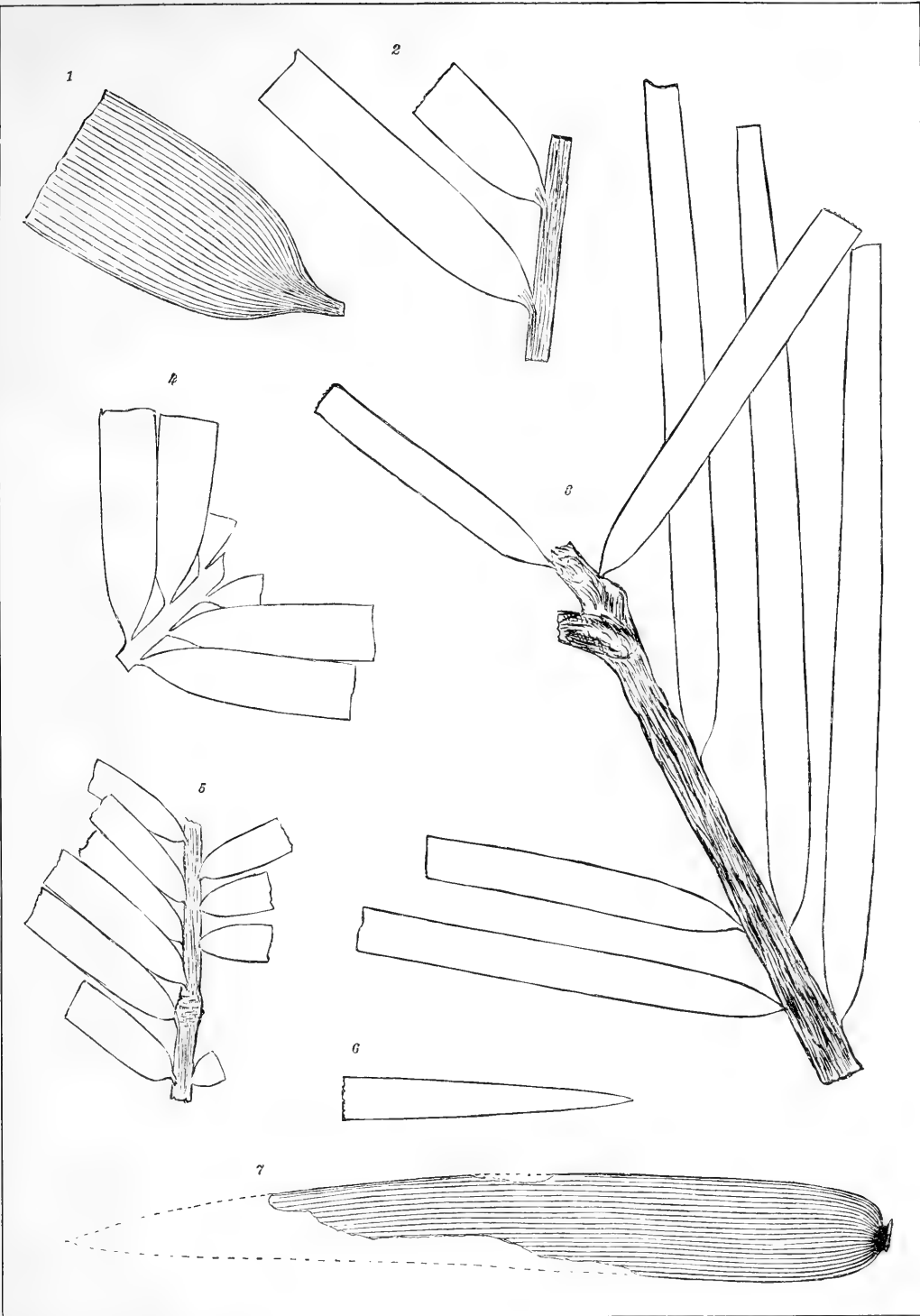



PLATE LXXVII.

PLATE LXXVII.

	Page.
FIGS. 1, 2. <i>NAGEIOPSIS LONGIFOLIA</i> , sp. nov.	195
1. Portion of a stem with wide leaves	195
2. Portion of a large leaf	195
FIG. 3. <i>NAGEIOPSIS DECRESCENS</i> , sp. nov.	199
3. Portion of a branch, with leaves diminishing in ascending	199
3 ^a . Leaf magnified	199
FIG. 4. <i>NAGEIOPSIS OVATA</i> , sp. nov.	199
4. Fragment of a leafy branch	199
4 ^a . Leaf magnified	199

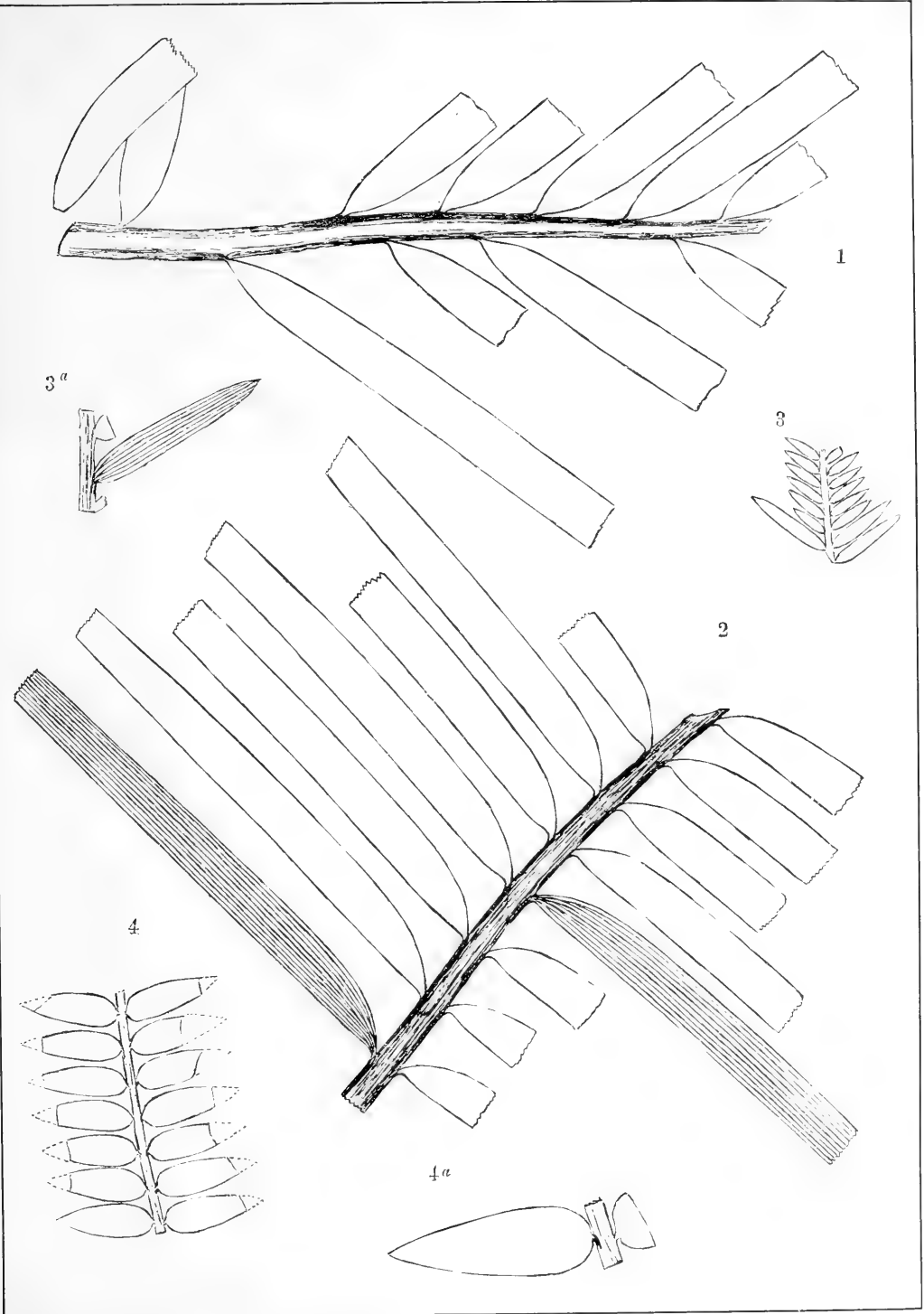



PLATE LXXVIII.

PLATE LXXVIII.

		Page.
FIGS. 1-5.	NAGEIOPSIS LONGIFOLIA, sp. nov.	195
	1. Portion of a large leafy branch	195
	2. Fragment of a leaf	195
	3. Portion of a leafy branch, showing alternate leaves—a rare feature—and the insertion of the bases of some of the leaves unusually far within the margin of the stem	195
	4. Fragment with an unusually large stem	195
	5. Portion from near the summit of a leafy branch	195
FIG.	6. ZAMITES TENUINERVIS, sp. nov.	171
	6. Portion of a broad leaf, showing only one margin	171
FIG.	7. PODOZAMITES PEDICELLATUS, sp. nov.	180
	7. Basal portion of a narrow leaf	180

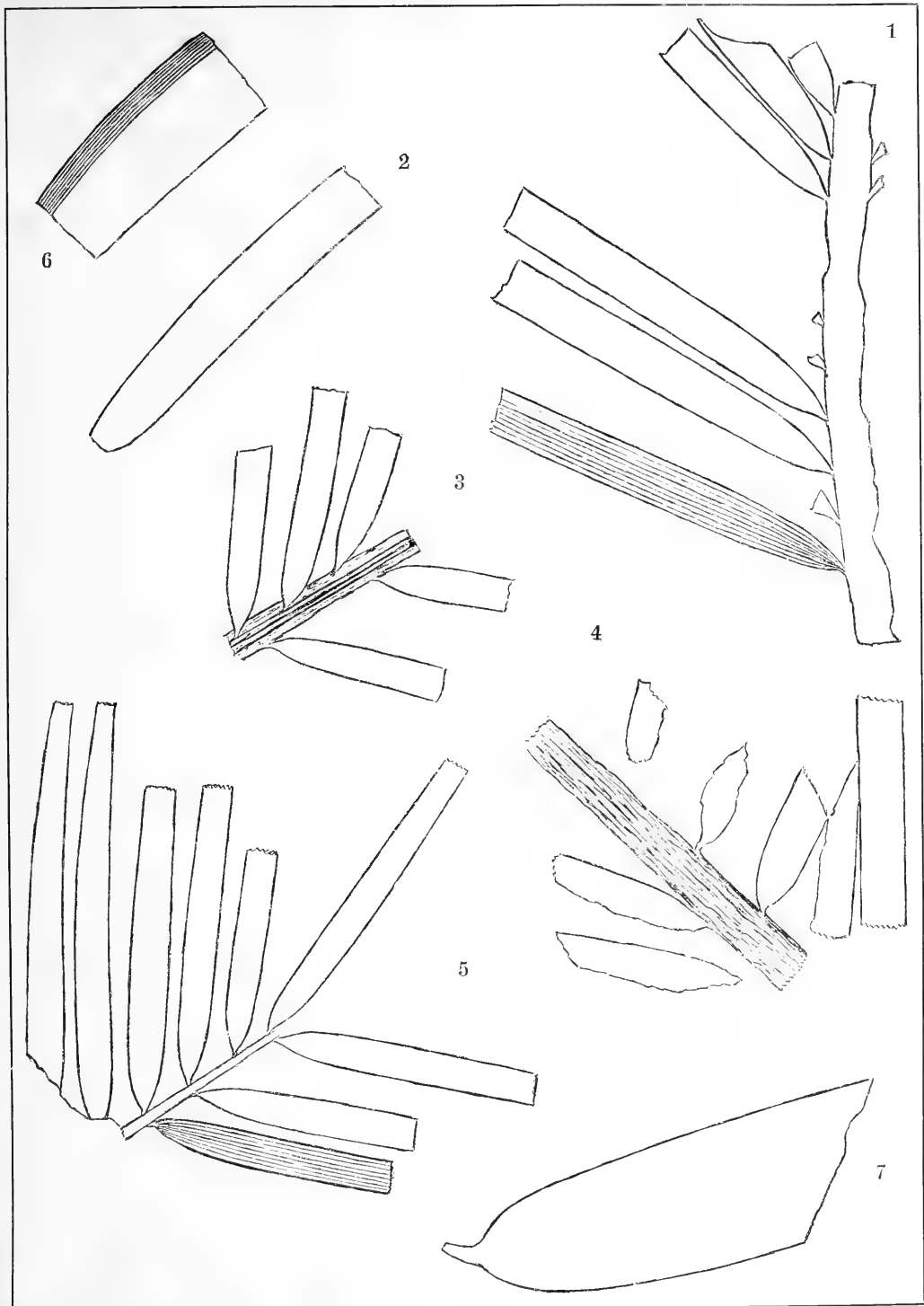

PLATE LXXIX.

PLATE LXXIX.

	Page.
FIGS. 1. 3. NAGEIOPSIS ZAMIOIDES, sp. nov.	196
1. Portions of a large branching stem with leaves of largest size.	196
3. Fragment of a leafy branch with large leaves.	196
FIGS. 2. 6. NAGEIOPSIS CRASSICAULIS, sp. nov.	198
2. Basal portion of a large leaf.	198
6. Basal portion of a leaf of medium size.	198
FIG. 4. NAGEIOPSIS RECURVATA, sp. nov.	197
4. Upper portion of a leaf.	197
FIG. 5. PODOZAMITES DISTANTINERVIS, sp. nov.	179
5. Portion of a leaflet of medium size.	179
FIG. 7. NAGEIOPSIS LONGIFOLIA, sp. nov.	195
7. Fragment of a leaf.	195

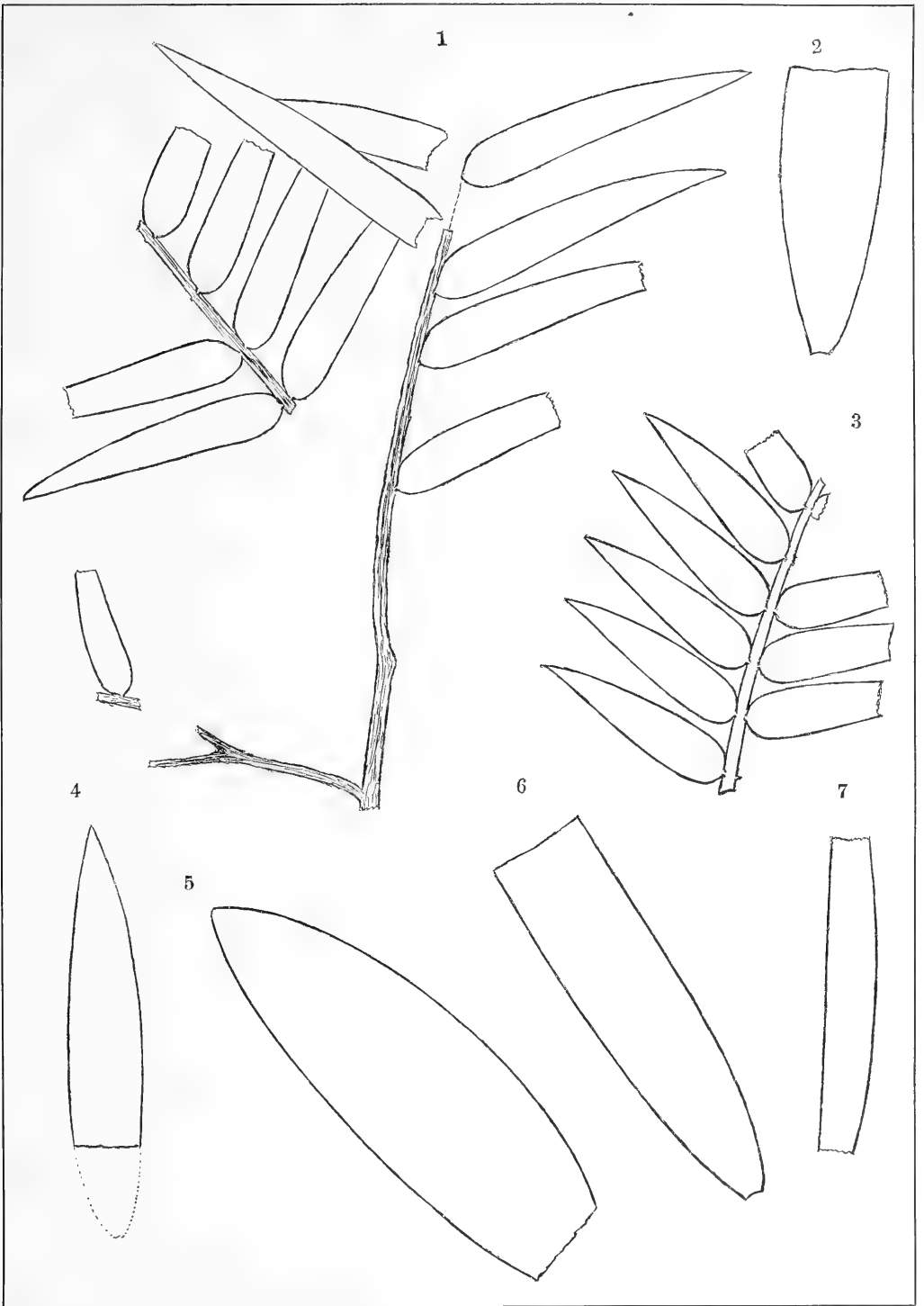
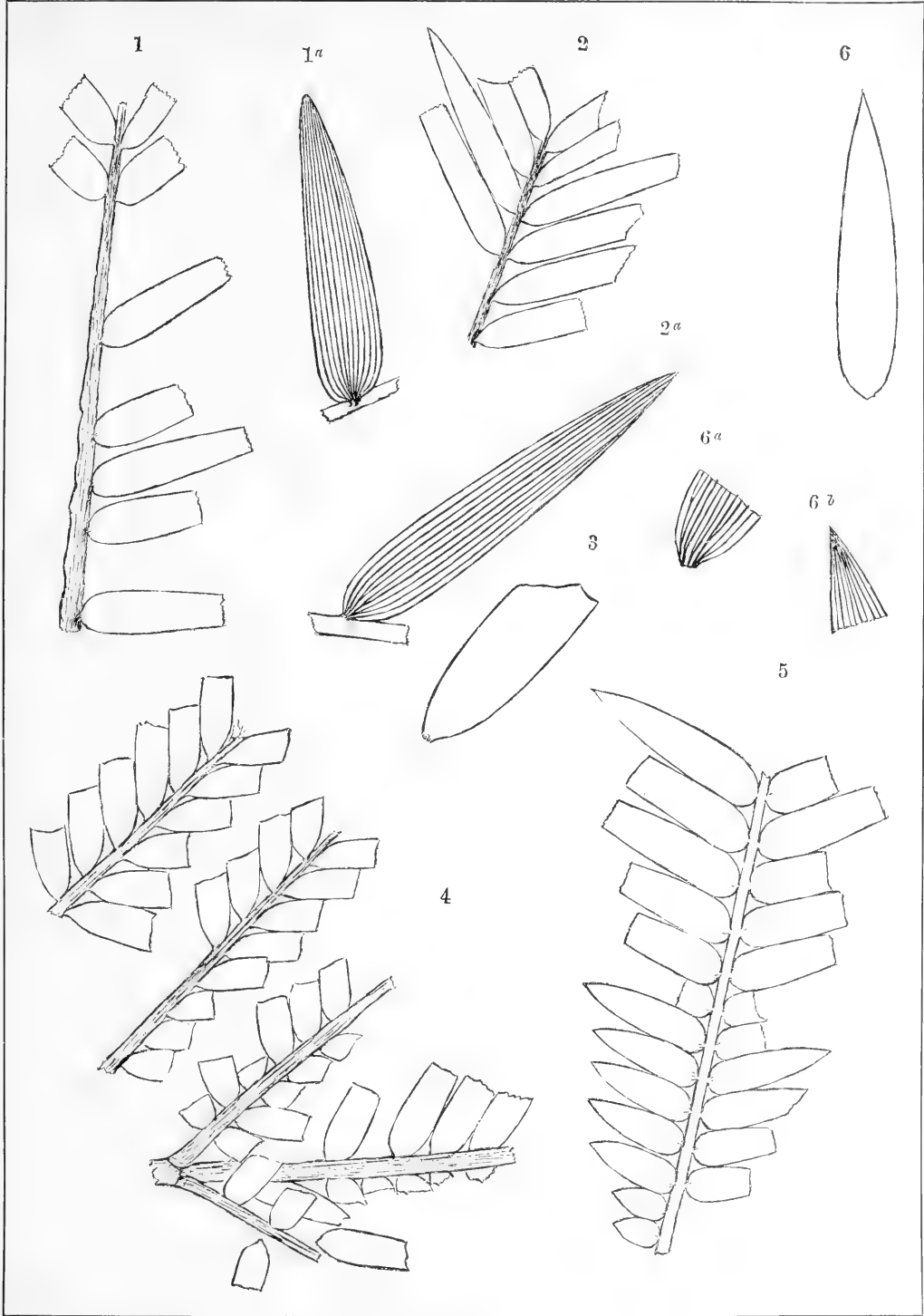



PLATE LXXX.

PLATE LXXX.

	Page.
FIGS. 1, 2, 4. NAGEIOPSIS ZAMOIDES, sp. nov	196
1. Fragment of a large branch	196
1 ^a . Leaf magnified	196
2. Fragment of a small branch	196
2 ^a . Leaf magnified	196
4. Fragments of a large branching stem	196
FIG. 3. NAGEIOPSIS RECURVATA sp. nov	197
3. Basal portion of a large leaf	197
FIG. 5. NAGEIOPSIS OVATA, sp. nov	199
5. Lower portion of a leafy branch, showing the gradual increase in the size of the leaves	199
FIG. 6. PODOZAMITES ACUTIFOLIUS, sp. nov	181
6. Detached leaflet	181
6 ^a . Basal portion of 6	181
6 ^b . Summit of the same magnified	181



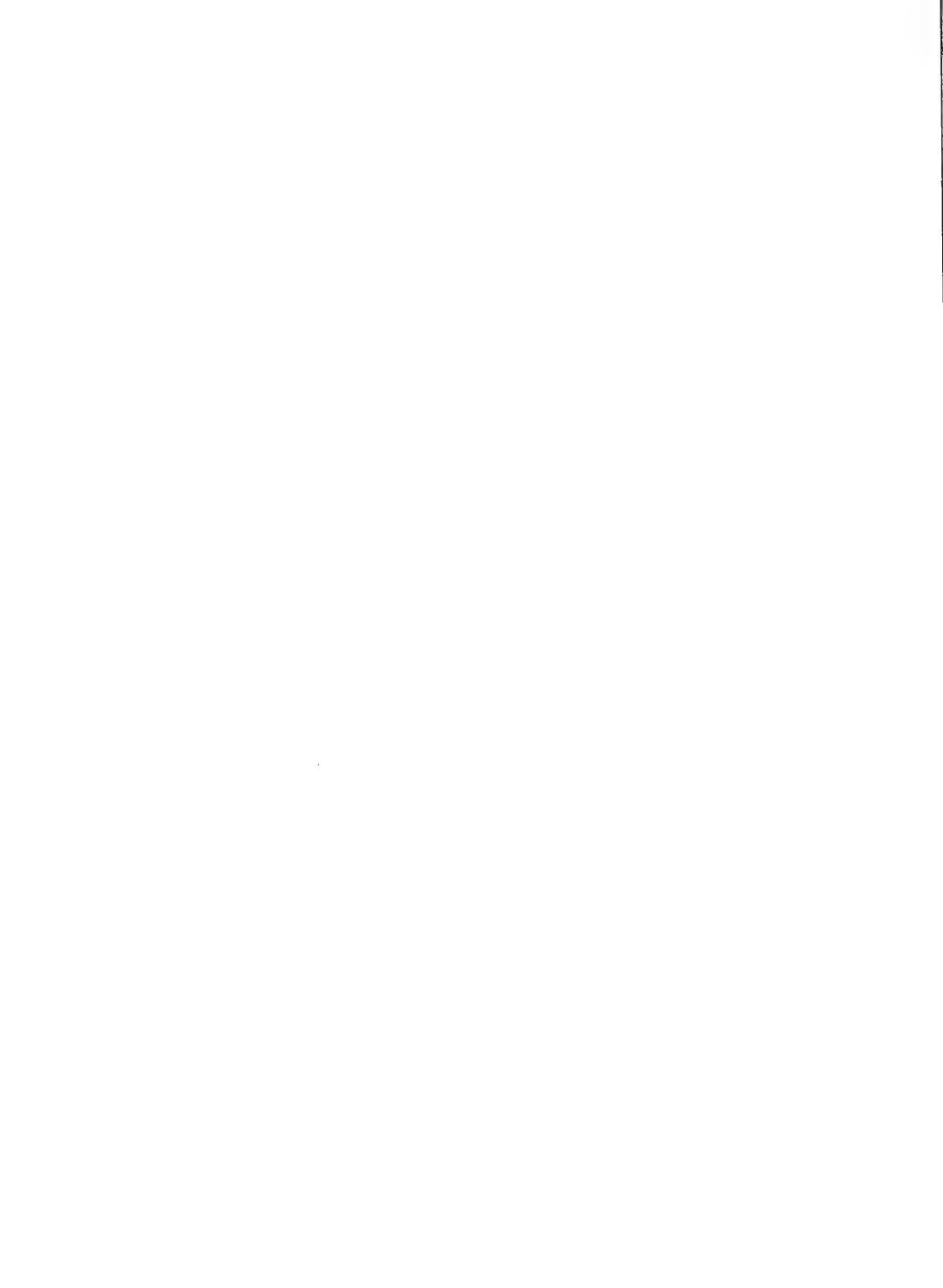

PLATE LXXXI.

P L A T E L X X X I .

	Page.
FIGS. 1-6. NAGEIOPSIS ZAMIOIDES, sp. nov.	196
1. Fragments of branches, the right-hand one showing on the left subordinate branches.	196
1 ^a . Leaf magnified	196
2. Small fragment of a branch with portions of large leaves	196
2 ^a . Leaf magnified	196
3. Fragment of a branch from near the base, showing small leaves.	196
3 ^a . Leaf magnified	196
4. Fragment of a branch with leaves of medium size	196
5. Fragments of what seems to be a branching limb	196
6. Portion of a branch with leaves of medium size	196

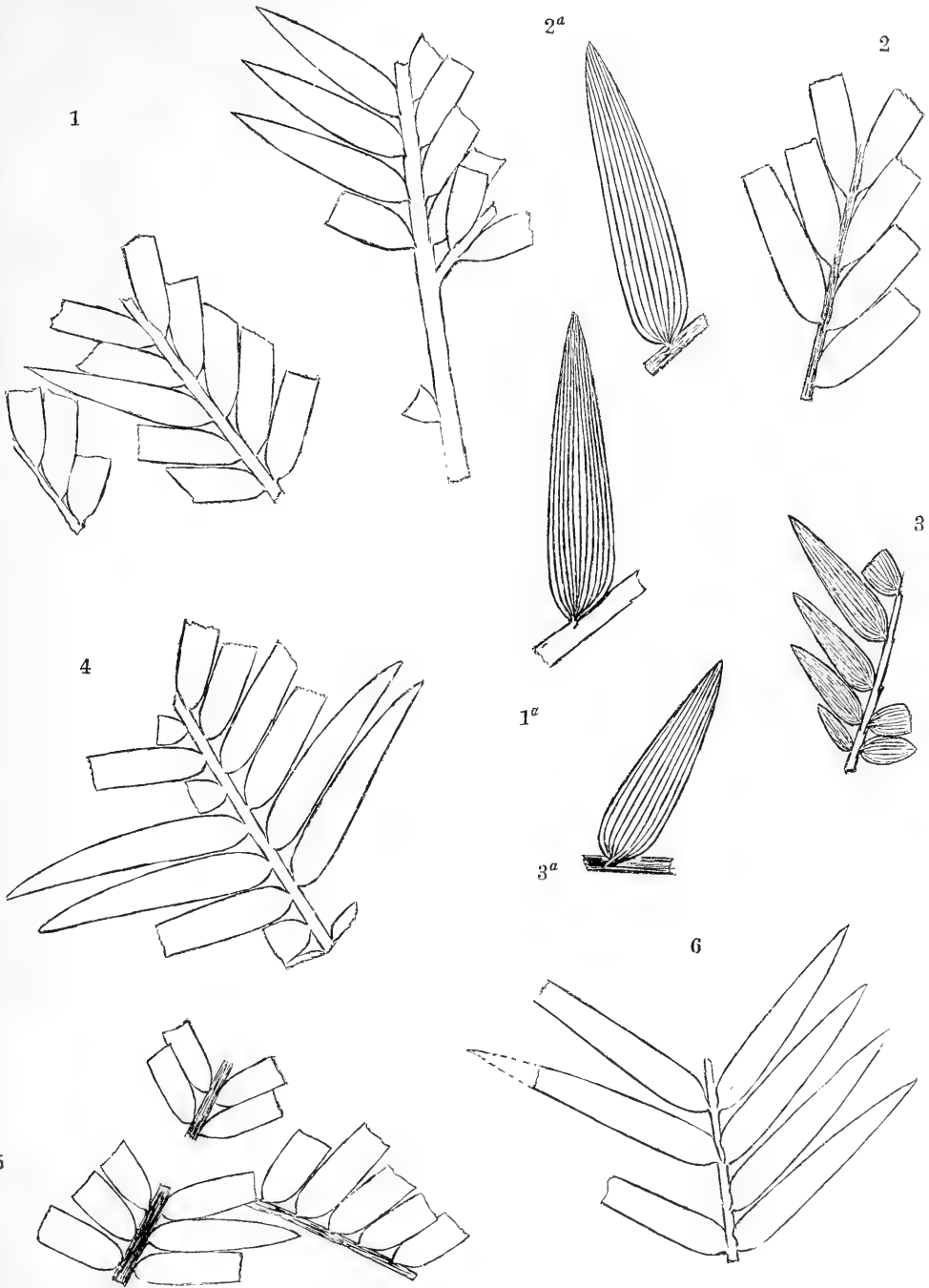



PLATE LXXXII.

PLATE LXXXII.

	Page.
FIG. 1. NAGEIOPSIS CRASSICAULIS, sp. nov.	198
1. Summit of a leafy branch	198
FIG. 2. PODOZAMITES GRANDIFOLIUS, sp. nov.	180
2. Fragment of a large leaflet	180
2 ^a . Fragment of 2 magnified to show nerves	180
FIG. 3. NAGEIOPSIS LATIFOLIA, sp. nov.	198
3. Fragment of a leaf	198
FIG. 4. PODOZAMITES DISTANTINERVIS, sp. nov.	179
4. Basal portion of a leaflet	179
FIG. 5. PODOZAMITES PEDICELLATUS, sp. nov.	180
5. Basal portion of a leaflet	180

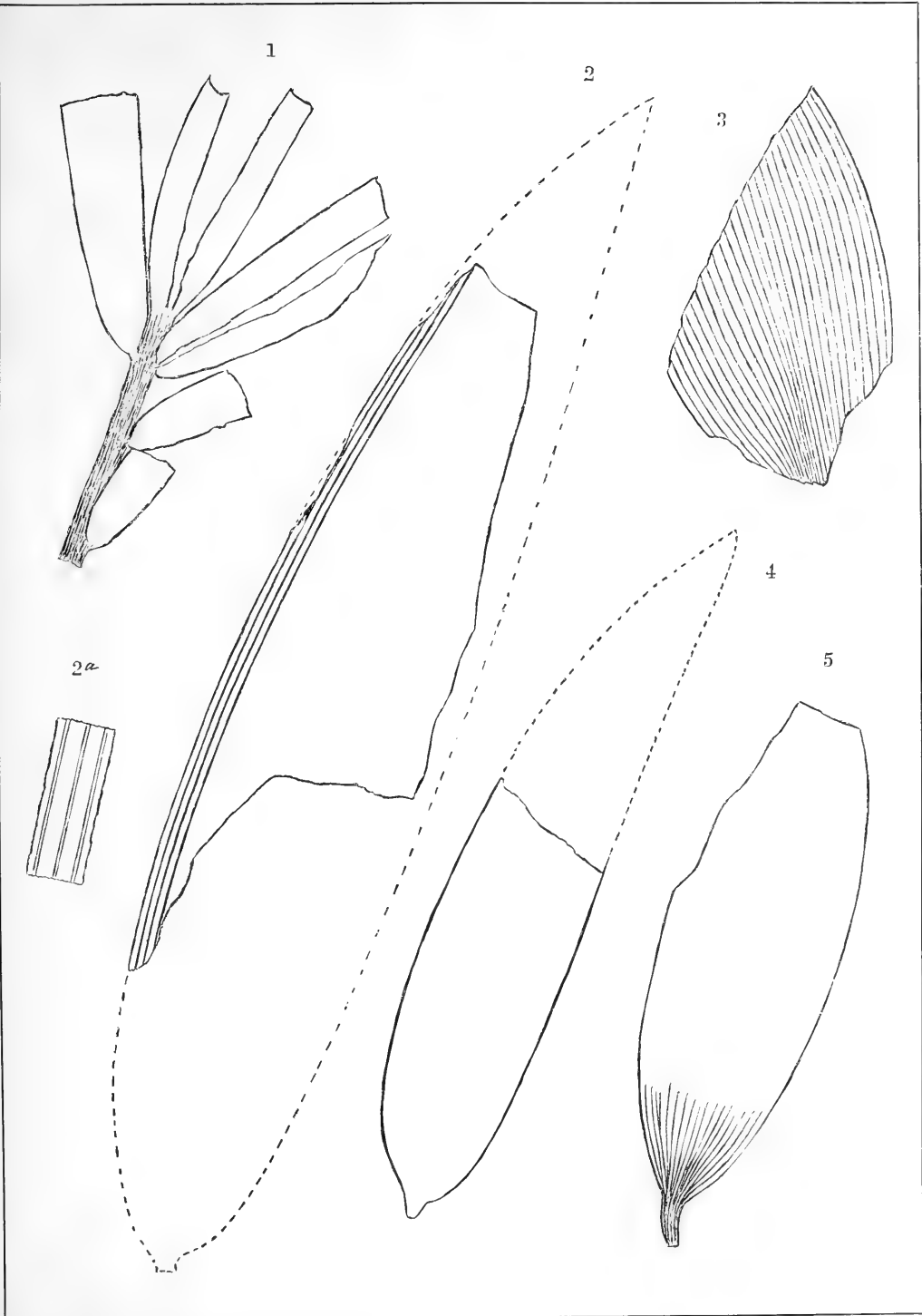

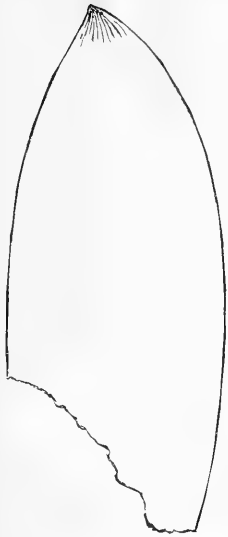

PLATE LXXIII.

PLATE LXXXIII.

	Page.
FIGS. 1, 2, 6, 7. PODOZAMITES DISTANTINERVIS, sp. nov.	179
1. Terminal portion of a leaflet of the largest size.....	179
2. Portions of two leaflets in natural position	179
6. Basal portion of a small leaflet.....	179
7. Portions of two leaves attached to the midrib.....	179
FIG. 3. ZAMITES CRASSINERVIS, sp. nov.	172
3. Entire detached leaflet	172
FIG. 4. ZAMITES DISTANTINERVIS, sp. nov.	172
4. Terminal portion of a leaf.....	172
FIG. 5. PODOZAMITES GRANDIFOLIUS, sp. nov.	180
5. Basal portion of a leaf.....	180

1



2

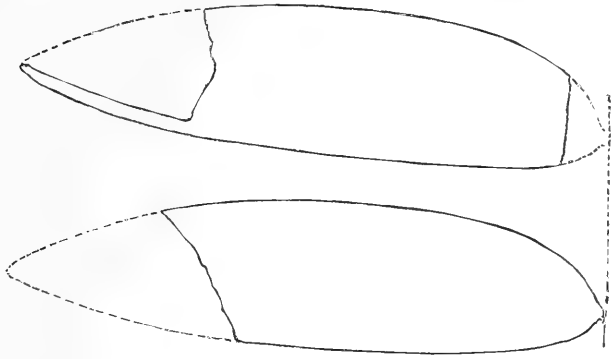

3

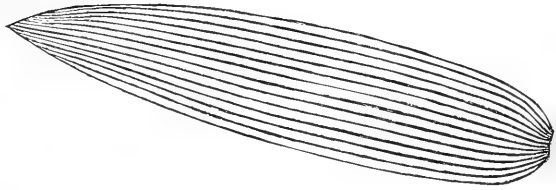

4

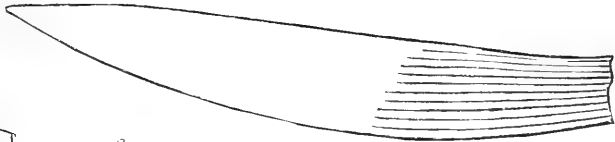

5

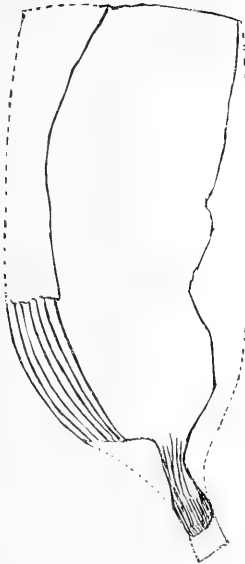

6

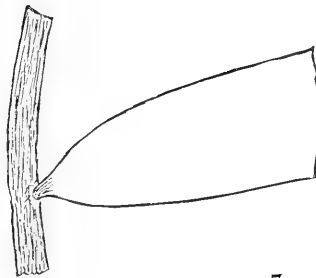

7

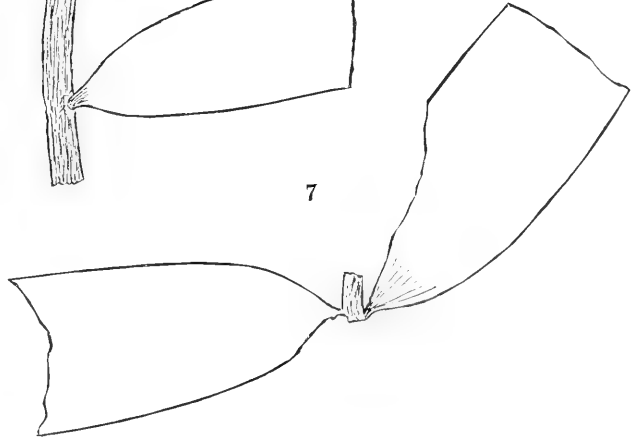

PLATE LXXXIV.

PLATE LXXXIV.

		Page.
Figs. 1, 2, 8, 10, 14, 15.	PODOZAMITES DISTANTINERVIS, sp. nov.	179
	1. Basal portion of a leaf	179
	2. Portion of a leaf with neither margin preserved	179
	8. Base of a leaflet abruptly rounded at base	179
	10. Three leaflets, detached and overlapping	179
	14. Base of a leaflet slightly enlarged	179
	15. Tip of a leaflet slightly enlarged	179
Figs.	3, 9, 11. NAGEIOPSIS CRASSICAULIS, sp. nov.	198
	3. Basal portion of a narrow leaf	198
	9. Small fragment of a leaf	198
	11. Terminal portion of a narrow leaf	198
	11 ^a . Portion enlarged	198
FIG.	4. NAGEIOPSIS HETEROPHYLLA, sp. nov.	201
	4. Small fragment of a leafy branch	201
FIG.	5. PHYLLOCLADOPSIS HETEROPHYLLA, sp. nov.	204
	5. Portion of several leafy branches	204
	5 ^a . Leaves magnified	204
FIG.	6. NAGEIOPSIS MICROPHYLLA, sp. nov.	201
	6. Small fragment of a leafy branch	201
FIG.	7. ZAMITES TENUINERVIS, sp. nov.	171
	7. Base of a leaflet of medium size	171
FIG.	12. ZAMITES? sp. ?	173
	12. Tip of a leaflet	173
FIG.	13. ZAMITES SUBFALCATUS, sp. nov.	173
	13. Terminal portion of a leaf	173

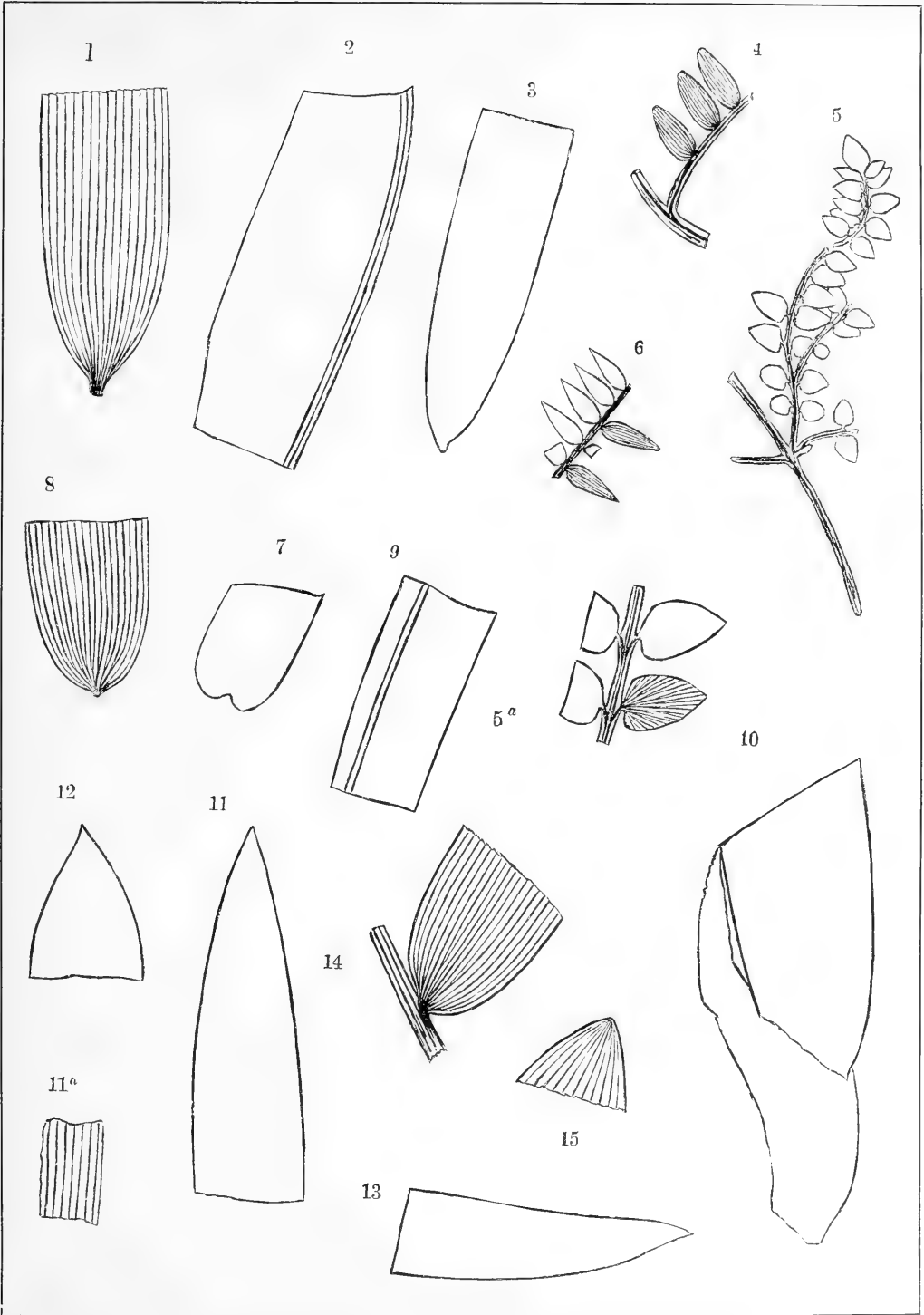

PLATE LXXXV.

PLATE LXXXV.

	Page.
Figs. 1, 2, 8, 9. NAGEIOPSIS LONGIFOLIA, sp. nov.	195
1. Portion of the upper part of a large leaf.	195
2. Basal portion of a large leaf.	195
8. Fragment from Deep Bottom. It has the nerves finer and more closely placed than usual.	195
9. Tip of a small leaf.	195
FIG. 3. ZAMITES SUBFALCATUS, sp. nov.	173
3. Basal portion of a leaflet.	173
FIG. 4. ZAMITES OVALIS, sp. nov.	173
4. Nearly entire leaflet.	173
FIG. 5. FEILDENIOPSIS CRASSINERVIS, sp. nov.	205
5. Nearly entire leaf.	205
5 ^a . Summit of 5 magnified.	205
FIG. 6. NAGEIOPSIS INEQUILATERALIS, sp. nov.	200
6. Entire leaf.	200
6 ^a . Summit of 6 magnified.	200
FIG. 7. NAGEIOPSIS OBTUSIFOLIA, sp. nov.	200
7. Leaf attached to the stem.	200
7 ^a . Magnified view of 7.	200
FIGS. 10, 15. PODOZAMITES ACUTIFOLIUS, sp. nov.	181
10, 15. Detached leaflets varying in size.	181
15 ^a . Summit of 15, magnified.	181
FIG. 11. NAGEIOPSIS ACUMINATA, sp. nov.	201
11. Entire leaf with a bit of the stem attached.	201
FIGS. 12, 16. PODOZAMITES DISTANTINERVIS, sp. nov.	179
12, 16. Fragments of large leaves.	179
FIG. 13. ARAUCARIA OBTUSIFOLIA, sp. nov.	249
13. Summit of a small twig.	249
13 ^a . Portion of 13 magnified.	249
FIG. 14. NAGEIOPSIS MICROPHYLLA, sp. nov.	201
14. Portion of a stem with very small leaves and a proportionally large stem.	201

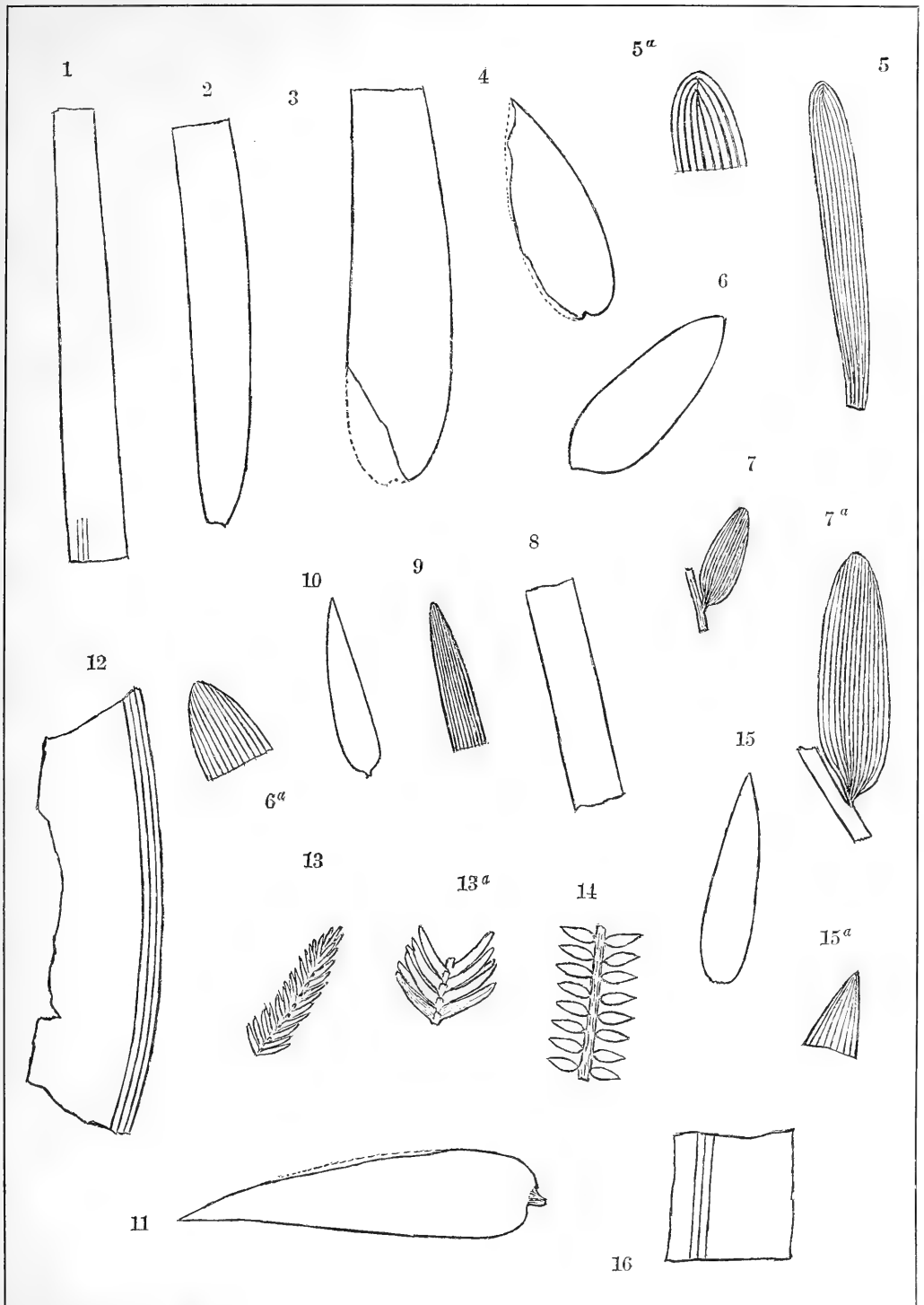

PLATE LXXXVI.

PLATE LXXXVI.

	Page.
FIGS. 1-3, 5. NAGEIOPSIS MICROPHYLLA, sp. nov	201
1. Summit of a leafy branch	201
2. Fragment of a leafy branch	201
3. Portion of a leafy branch with leaves of unusual shape	201
5. Stem with leafy branches	201
FIG. 4. ARAUCARIA PODOCARPOIDES, sp. nov	249
4. Small portion of a branch	249
FIG. 6, 7. NAGEIOPSIS HETEROPHYLLA, sp. nov	201
6. Portion of a large stem with two leafy branches	201
6 ^a . Leaf magnified	201
7. Portion of a stem with dissimilar leaves	201
FIGS. 8, 9. NAGEIOPSIS ANGUSTIFOLIA, sp. nov	202
8. Portion of a leafy stem with two opposite branches	202
9. Fragment of a stem carrying a leafy branch, which in turn has two opposite branches	202

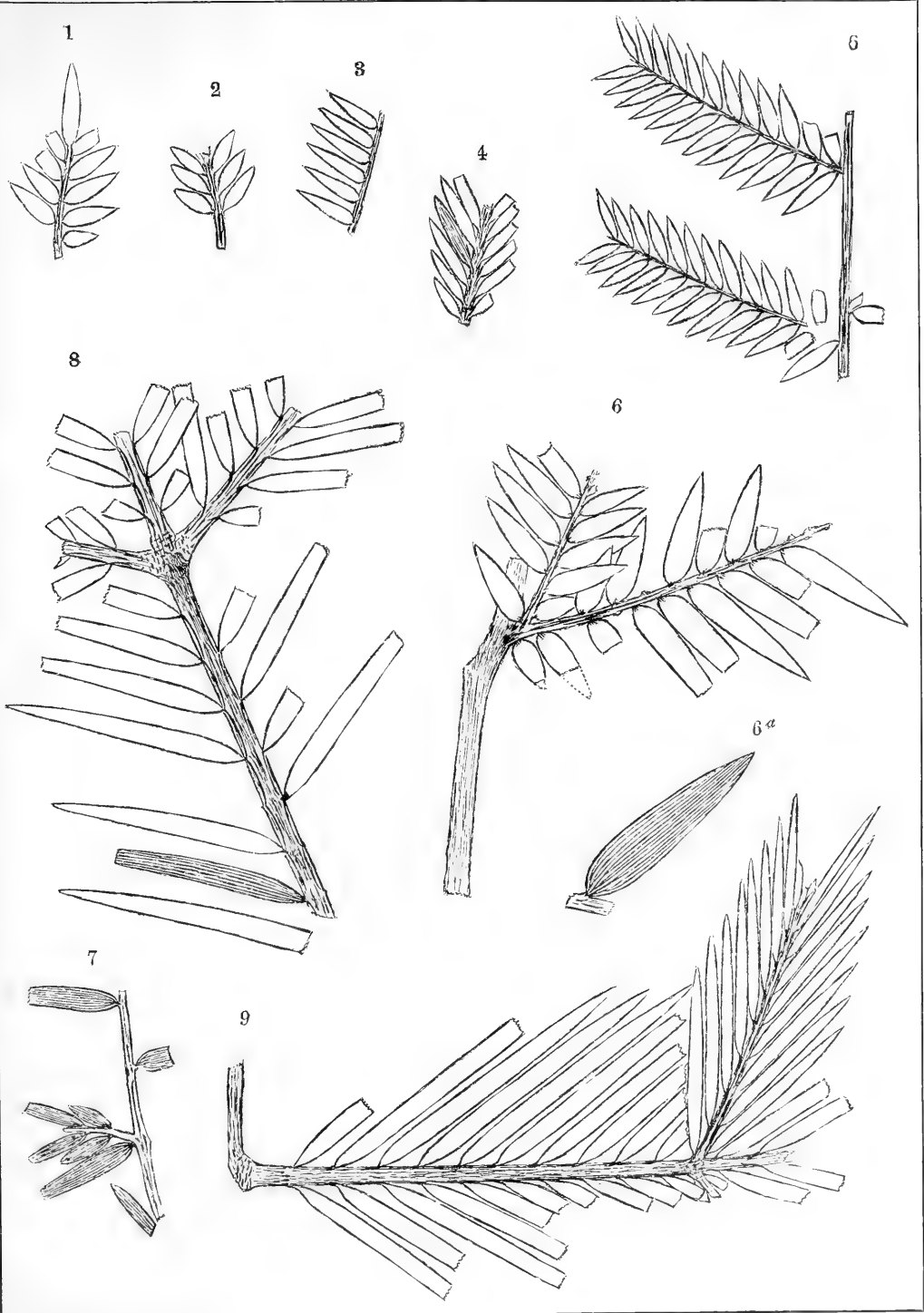

PLATE LXXXVII.

P L A T E L X X X V I I .

	Page-
FIG. 1. <i>PODOZAMITES ACUTIFOLIUS</i> , sp. nov.	181
1. Portion of a detached leaflet	181
FIGS. 2-6. <i>NAGEIOPSIS ANGUSTIFOLIA</i> , sp. nov.	202
2. Portion of a leafy stem with two opposite branches.	202
2 ^a . Leaf magnified	202
3. Fragment of a stem with very narrow leaves.	202
4. Portions of two leafy branches.	202
5. Portion of a large branching stem	202
5 ^a . Leaf enlarged	202
6. Fragment of a leafy stem	202
6 ^a . Basal portion of a leaf magnified	202

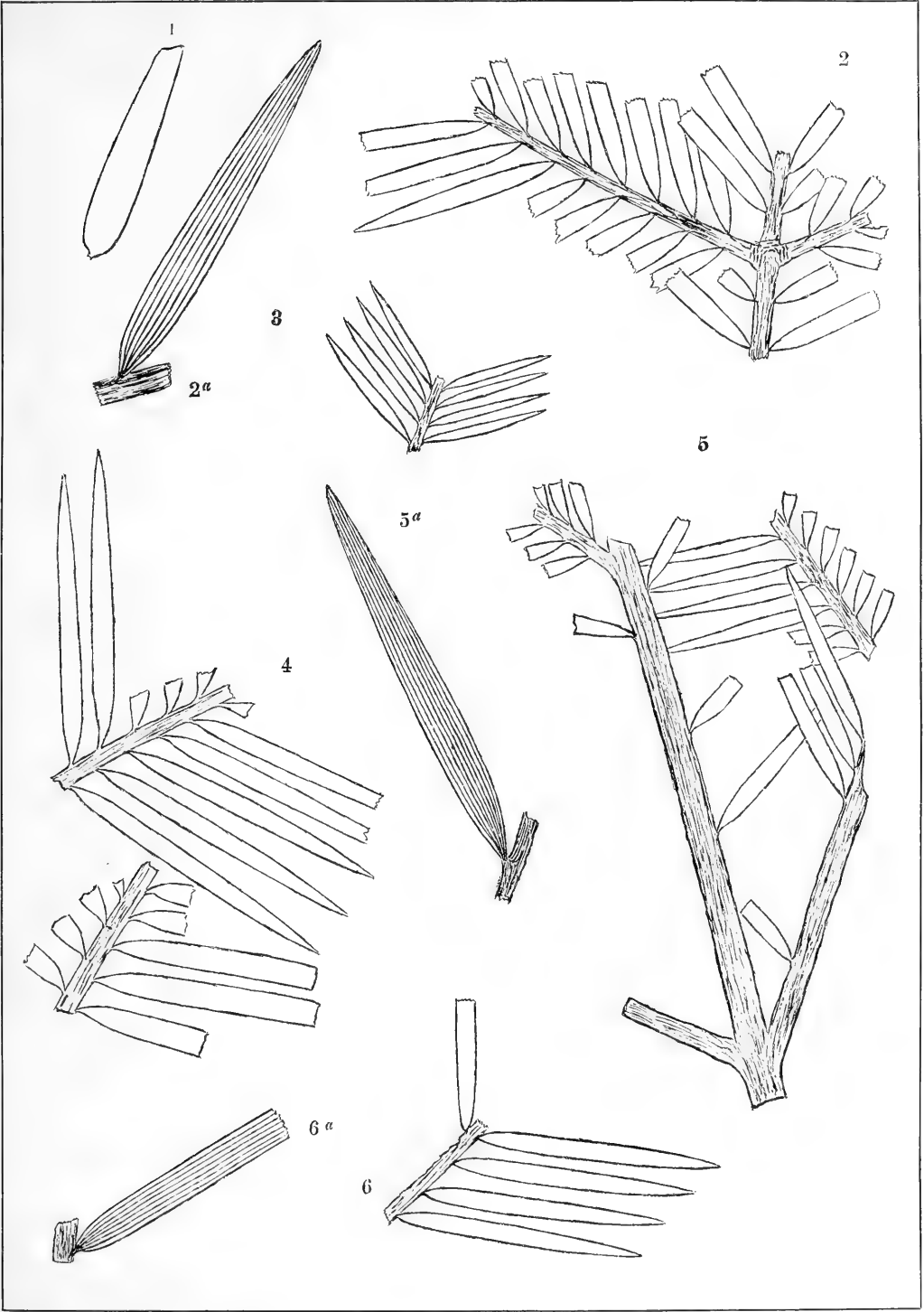



PLATE LXXXVIII.

PLATE LXXXVIII.

	Page.
FIGS. 1, 3, 4, 6-8. <i>NAGEIOPSIS ANGUSTIFOLIA</i> , sp. nov.	202
1. Portions of leafy branches with narrow leaves unequal in size	202
3. Portion of a branching stem with small leaves	202
4. Small fragment of a leafy branch	202
6. Fragments of two branches.	202
7. Portion of a branch with large leaves	202
8. Portion of a branching stem with very narrow leaves.	202
FIG. 2, 5. <i>NAGEIOPSIS HETEROPHYLLA</i> , sp. nov.	201
2. Portion of a branching stem, showing the basal leaves on the upper side of the ultimate branches smaller than the rest.	201
2 ^a . Leaf magnified, nerves not fully shown.	201
5. Terminal portion of an ultimate branch, showing the terminal leaf.	201

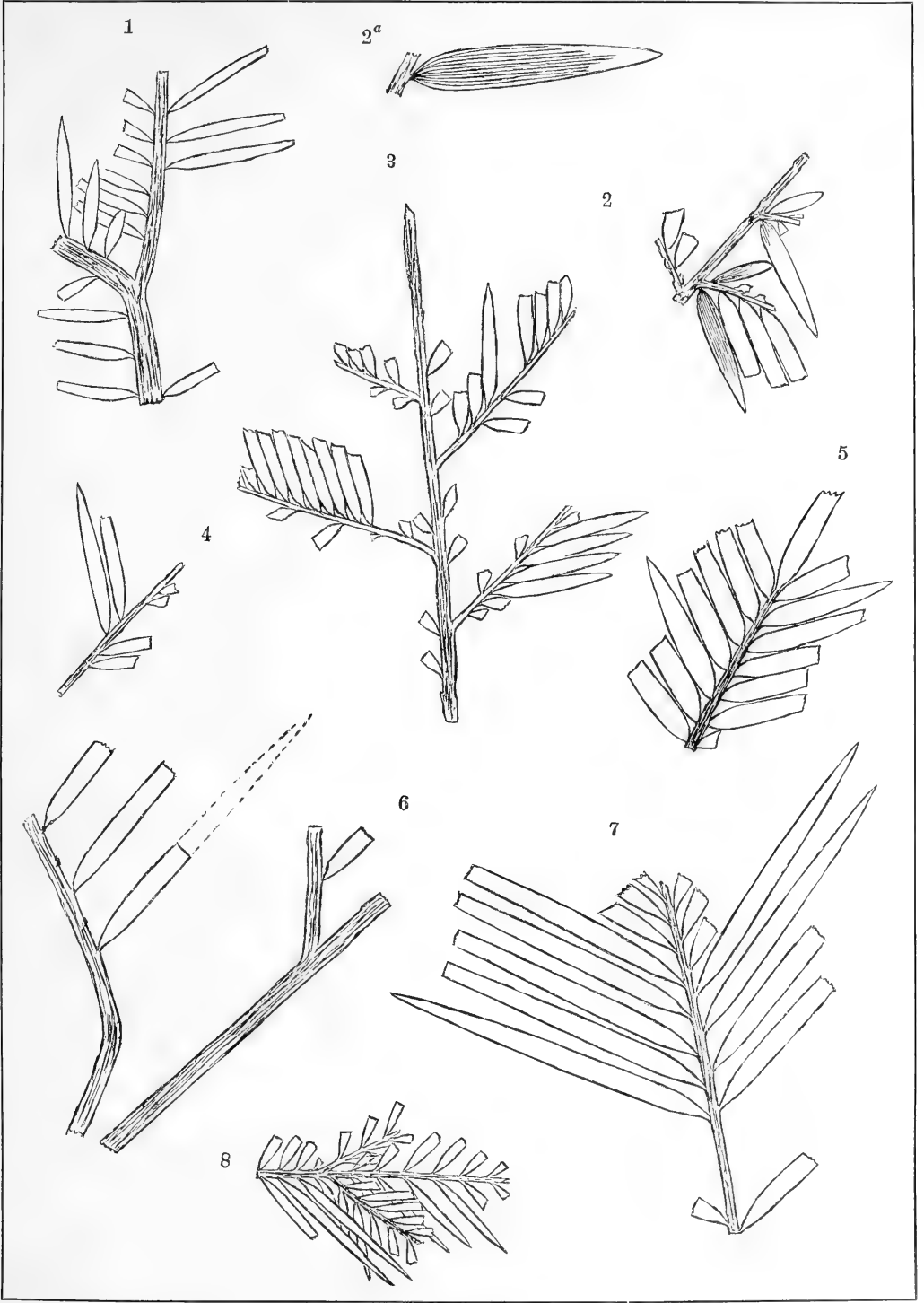



PLATE LXXXIX.

PLATE LXXXIX.

	Page.
FIGS. 1, 3. BAIEROPSIS EXPANSA, sp. nov.	207
1. Portion of terminal leaf with fragments of the next lower right-hand leaf	207
3. Fragments of the terminal leaf with a portion of the next lower right-hand leaf...	207
3 ^a . Fragment of 3 magnified.....	207
FIG. 2. NAGEIOPSIS ANGUSTIFOLLA, sp. nov.....	202
2. Fragment of a leafy branch	202
2 ^a . Leaf of 2 magnified.....	202
FIG. 4. BAIEROPSIS PLURIPARTITA, sp. nov.	208
4. Summit of a leafy stem with leafy branches	208

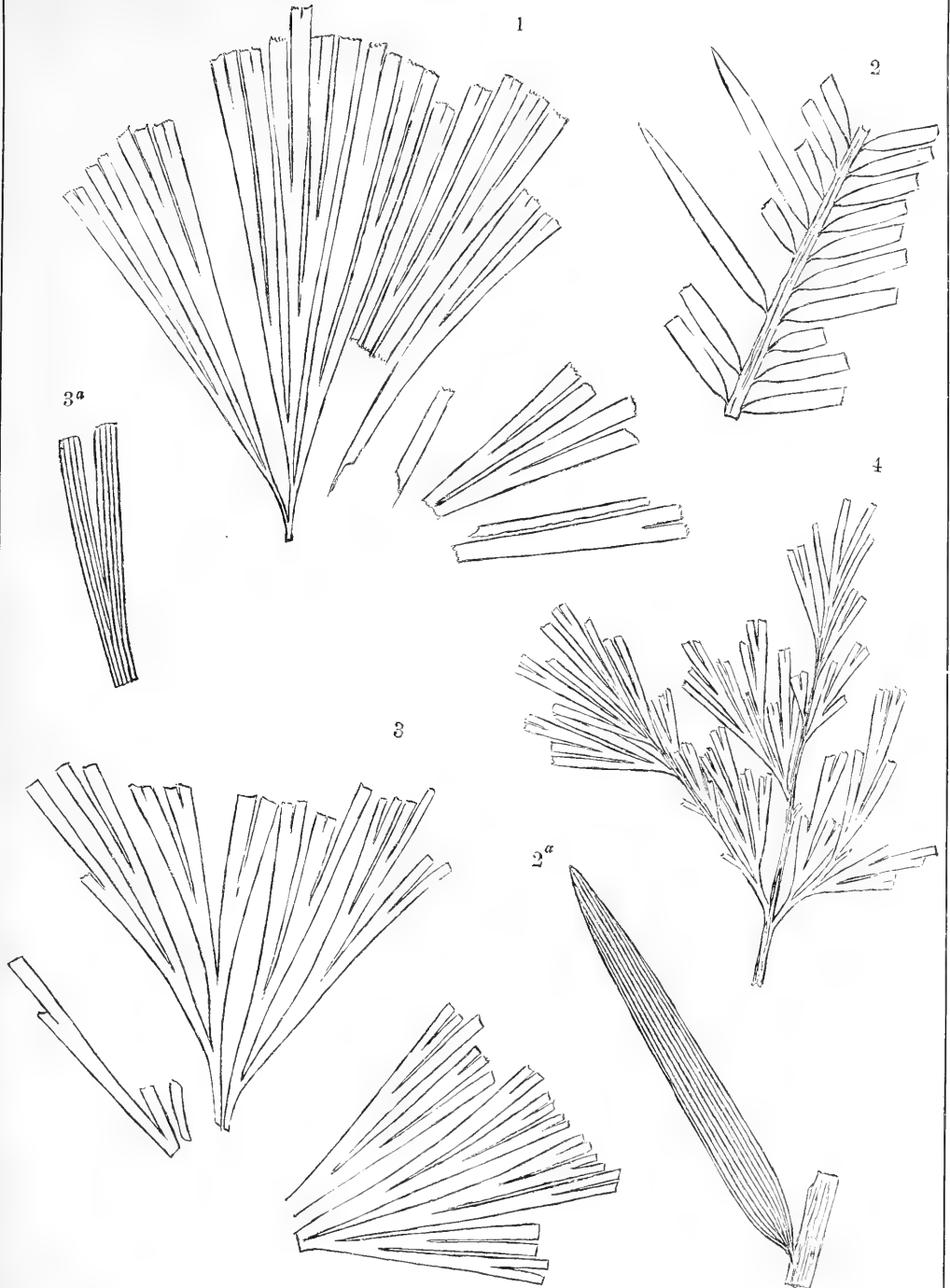

PLATE XC.

P L A T E X C.

		Page.
FIG.	1. <i>BAIEROPSIS EXPANSA</i> , sp. nov.	207
	1. Fragments of several subordinate laciniae.....	207
FIGS. 2-5.	<i>BAIEROPSIS PLURIPARTITA</i> , sp. nov.	208
	2. Summit of a stem, showing part of a terminal leaf and the next lower pair, with portions of still lower leaves on leafy branches.....	208
	2 ^a . Portion of a primary segment magnified.....	208
	3. Summit of a leafy branch with portions of the terminal leaf and of the pair next below and fragments of lower leafy branches.....	208
	4. Portion of a stem carrying what seem to be small nut-like seed.....	208
	4 ^a . Portion of 4 magnified.....	208
	5. Terminal portion of a stem with leafy branches.....	208
GIG.	6. <i>BAIEROPSIS MACROPHYLLA</i> , sp. nov.	212
	6. Fragments of a very large leaf bearing curious excrescences on its surface.....	212
	6 ^a . Portion magnified, to show the character of the excrescences.....	212

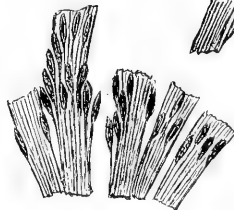
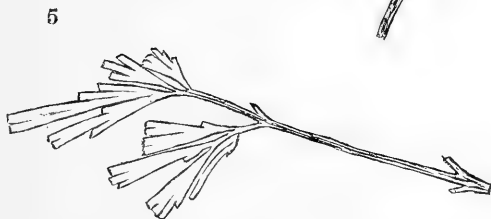
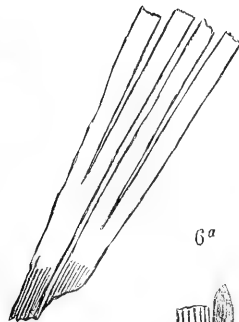
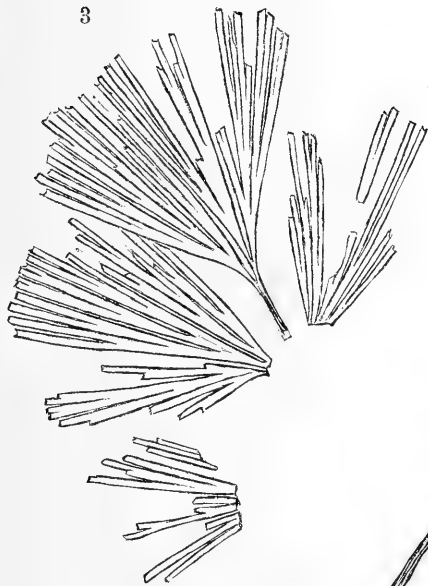
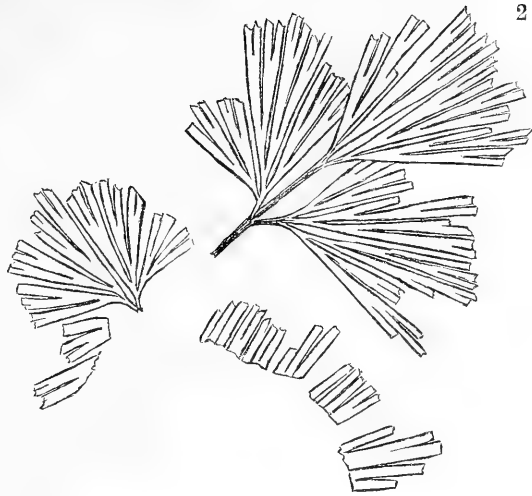
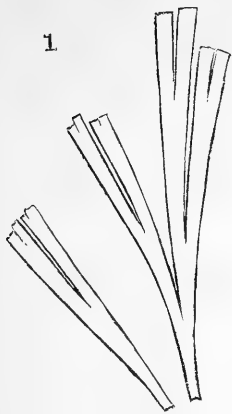

PLATE XCI.

PLATE XCI.

	Page.
FIGS. 1, 3, 4, 7. <i>BAIEROPSIS PLURIPARTITA</i> , sp. nov.	208
1. Portion of the summit of a primary leafy branch.....	208
3. Portion of a primary leafy branch with fragments of several subordinate leafy branches.....	208
3 ^a . Portion of a primary segment of a leaf magnified. The tips of the ultimate laciniae are not depicted.....	208
4. Portion of a primary and two subordinate leafy branches.....	208
7. Small fragment of a primary leafy branch with traces of fructification.....	208
FIG. 2. <i>BAIEROPSIS EXPANSA</i> , sp. nov.	207
2. Fragment of a stem with portions of leaves on each side.....	207
2 ^a . Portion of a segment of a leaf magnified.....	207
FIG. 5. <i>BAIEROPSIS PLURIPARTITA</i> , var. <i>MINOR</i> , sp. nov.	208
5. Portions of the leaves on a subordinate leafy branch.....	208
FIG. 6. <i>BAIEROPSIS LONGIFOLIA</i> , sp. nov.	210
6. Portions of leafy branches showing unusually long segments in the leaves.....	210

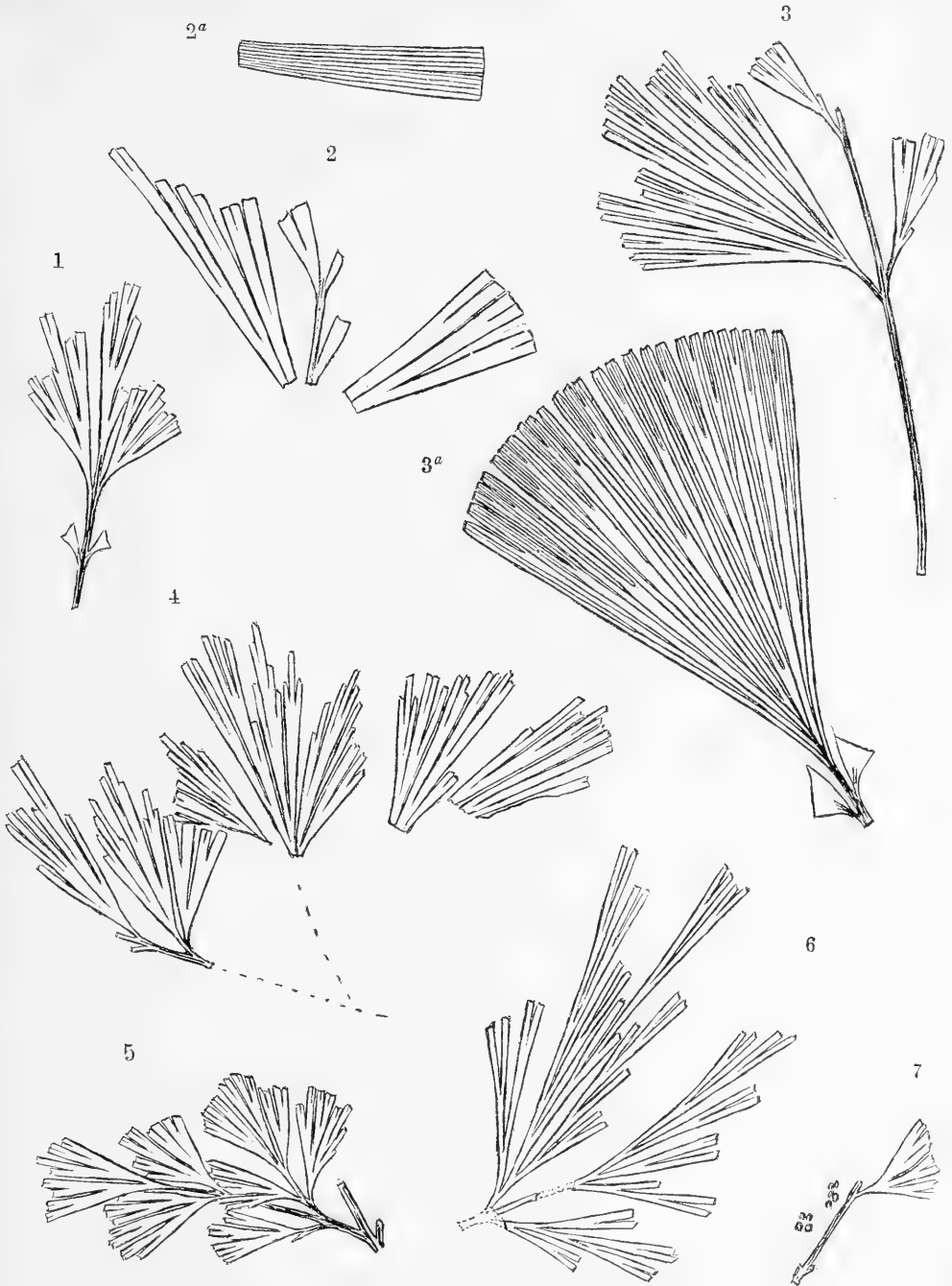

PLATE XCII.

PLATE XCII.

	Page.
FIGS. 1, 2, 6. <i>BAIEROPSIS PLURIPARTITA</i> , sp. nov.	208
1. Fragments of the upper part of a primary leafy branch with portions of the subordinate leafy branches on the right-hand side	208
2. Fragment of the upper part of a primary leafy branch	208
6. Fragment of a primary leafy branch, showing a portion of the terminal leaf and fragments of the lower subordinate leafy branches	208
FIGS. 3, 4. <i>BAIEROPSIS PLURIPARTITA</i> , var. <i>MINOR</i> , sp. nov.	208
3. Portion of the upper part of a primary leafy branch	208
4. Fragments of the subordinate leafy branches	208
FIG. 5. <i>BAIEROPSIS EXPANSA</i> , sp. nov.	207
5. Portions of several laciniae	207
FIG. 7. <i>BAIEROPSIS DENTICULATA</i> , var. <i>ANGUSTIFOLIA</i> , sp. nov.	210
7. Portion of a primary leafy branch	210
7 ^a . Leaf magnified	210
FIGS. 8, 9. <i>BAIEROPSIS ADIANTIFOLIA</i> , sp. nov.	211
8. Reproduction of several leaves of natural size	211
8 ^a . Leaf reproduced and magnified	211
9. Fragment of an unusually large leaf	211

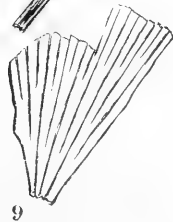
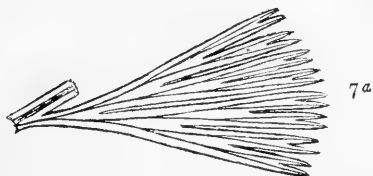
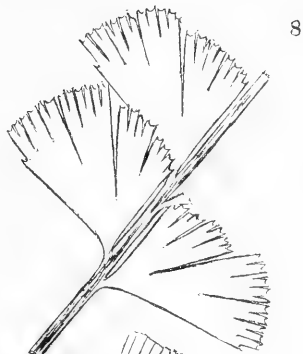
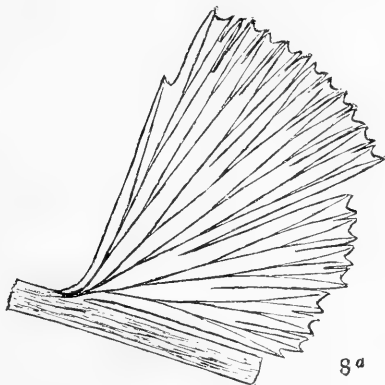
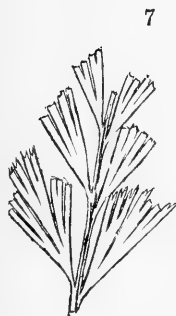
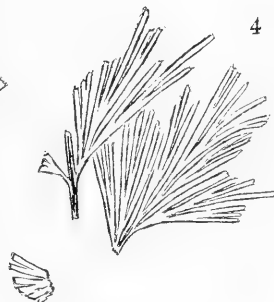
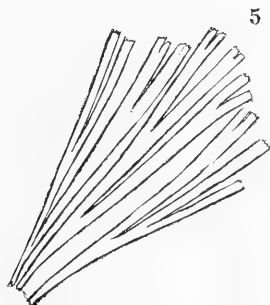
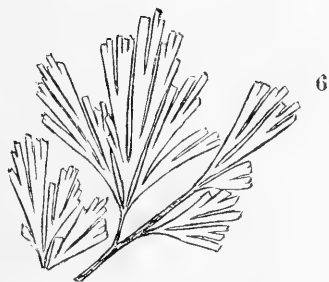
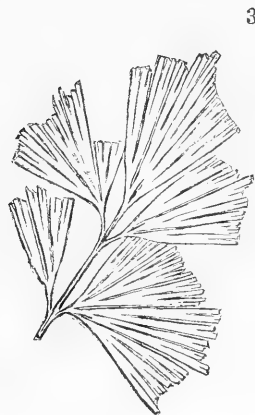
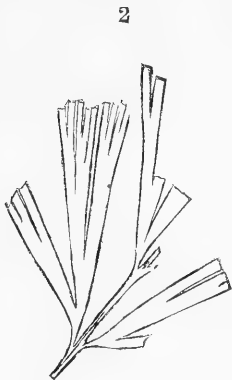
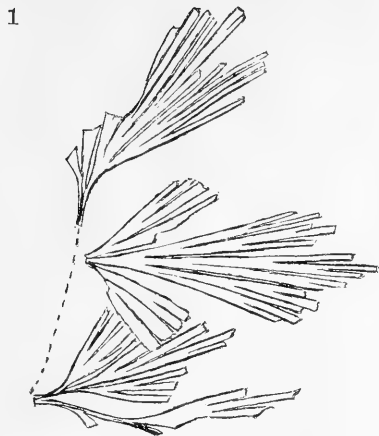

PLATE XCIII.

PLATE XCIII.

	Page.
FIGS. 1-3. <i>BAIEROPSIS ADIANTIFOLIA</i> , sp. nov.	211
1. Several fragments of leaves with an entire leaf.	211
1 ^a . Leaf magnified.	211
2. Upper portion of a leafy branch with parts of several leaves of large size.	211
3. Terminal portion of a leafy branch with portions of all the leaves originally present.	211
FIGS. 4-6. <i>BAIEROPSIS FOLIOSA</i> , sp. nov.	209
4. Portion of a primary leafy branch having small and comparatively broad leaves.	209
4 ^a . Leaf magnified.	209
5. Summit of a primary leafy branch, showing portions of the leaves and of the subordinate leafy branches.	209
6. Summit of a leafy branch with narrow leaves.	209
6 ^a . Leaf magnified.	209
FIG. 7. <i>BAIEROPSIS DENTICULATA</i> , sp. nov.	210
7. Portion of a primary branch carrying portions of several subordinate leafy branches.	210
7 ^a . Leaf restored and magnified.	210

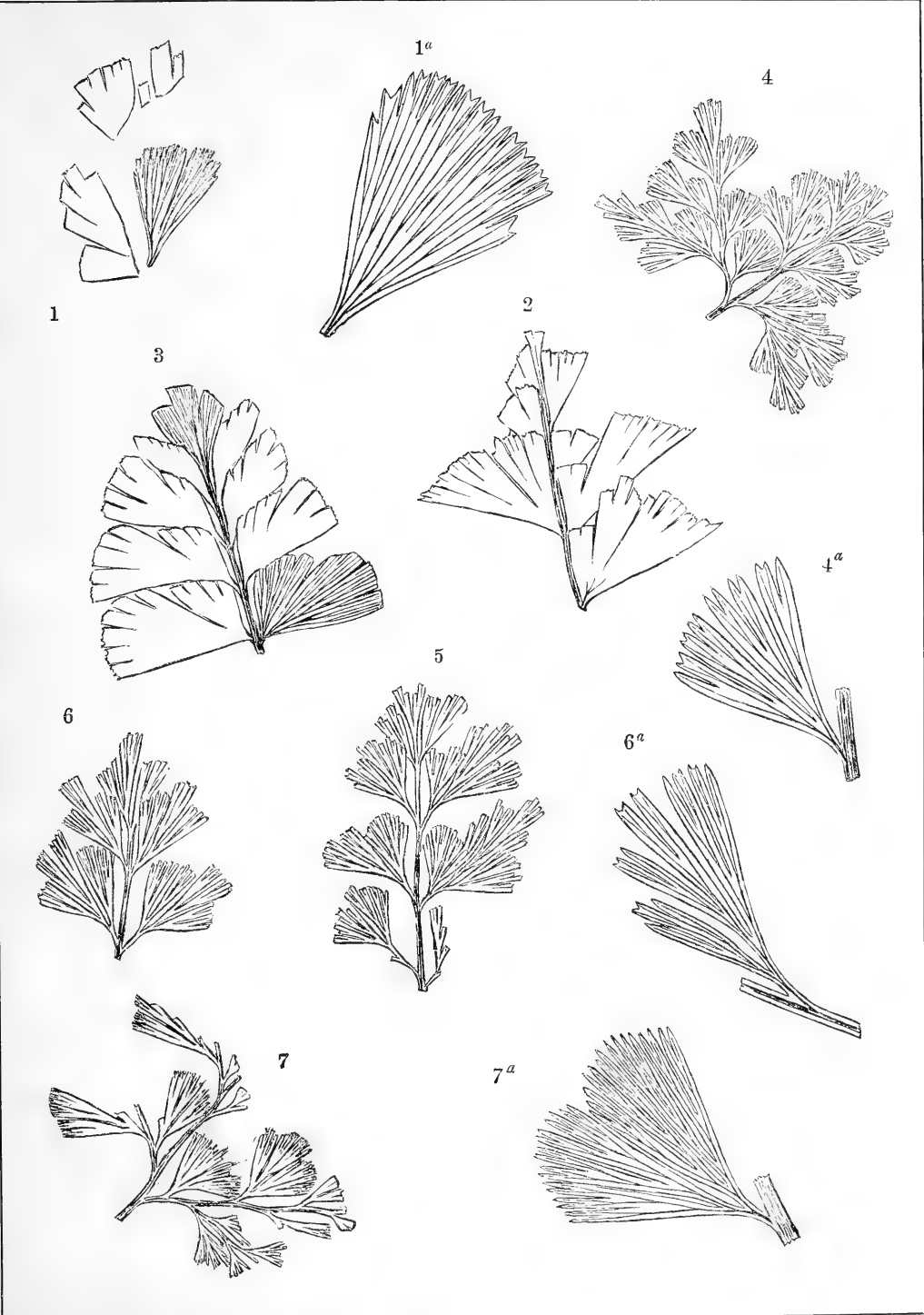

PLATE XCIV.

PLATE XCIV.

	Page.
FIG. 1. BAIEROPSIS ADIANTIFOLIA, var. MINOR, sp. nov.	212
1. Summit of a leafy branch with portions of several leaves	212
1 ^a . Leaf restored and magnified	212
FIGS. 2, 3. BAIEROPSIS ADIANTIFOLIA, sp. nov.	211
2. Fragments of several leaves	211
3. Portion of the stem with fragments of several leaves	211
FIG. 4. ACROSTICHOPTERIS DENSIFOLIA, sp. nov.	107
4. Small fragment of a compound pinna	107
4 ^a . Leaf magnified	107
FIGS. 5, 9, 10, 12. ACROSTICHOPTERIS PARVIFOLIA, sp. nov.	108
5. Portion of a small subordinate branch	108
5 ^a . Leaf magnified	108
9. Portion of a primary branch with two subordinate ones	108
9 ^a . Leaf magnified	108
10. Summit of a leafy branch	108
10 ^a . Leaf restored and magnified	108
12. Portion of a primary leafy stem with several subordinate leafy branches	108
12 ^a . Leaf magnified	108
FIGS. 6, 7, 11, 14. ACROSTICHOPTERIS PARCELOBATA, sp. nov.	108
6, 7. Portions of stems with fragments of leaves	108
11. Portion of the summit of a branch with several entire leaves	108
11 ^a . Leaf magnified	108
14. Entire leaf magnified, corresponding to a leaf of 6	108
FIG. 8. ACROSTICHOPTERIS CYCLOPTEROIDES, sp. nov.	109
8. Detached entire leaf	109
FIG. 13. BAIERA FOLIOSA, sp. nov.	213
13. Summit of a branch carrying many leaves	213

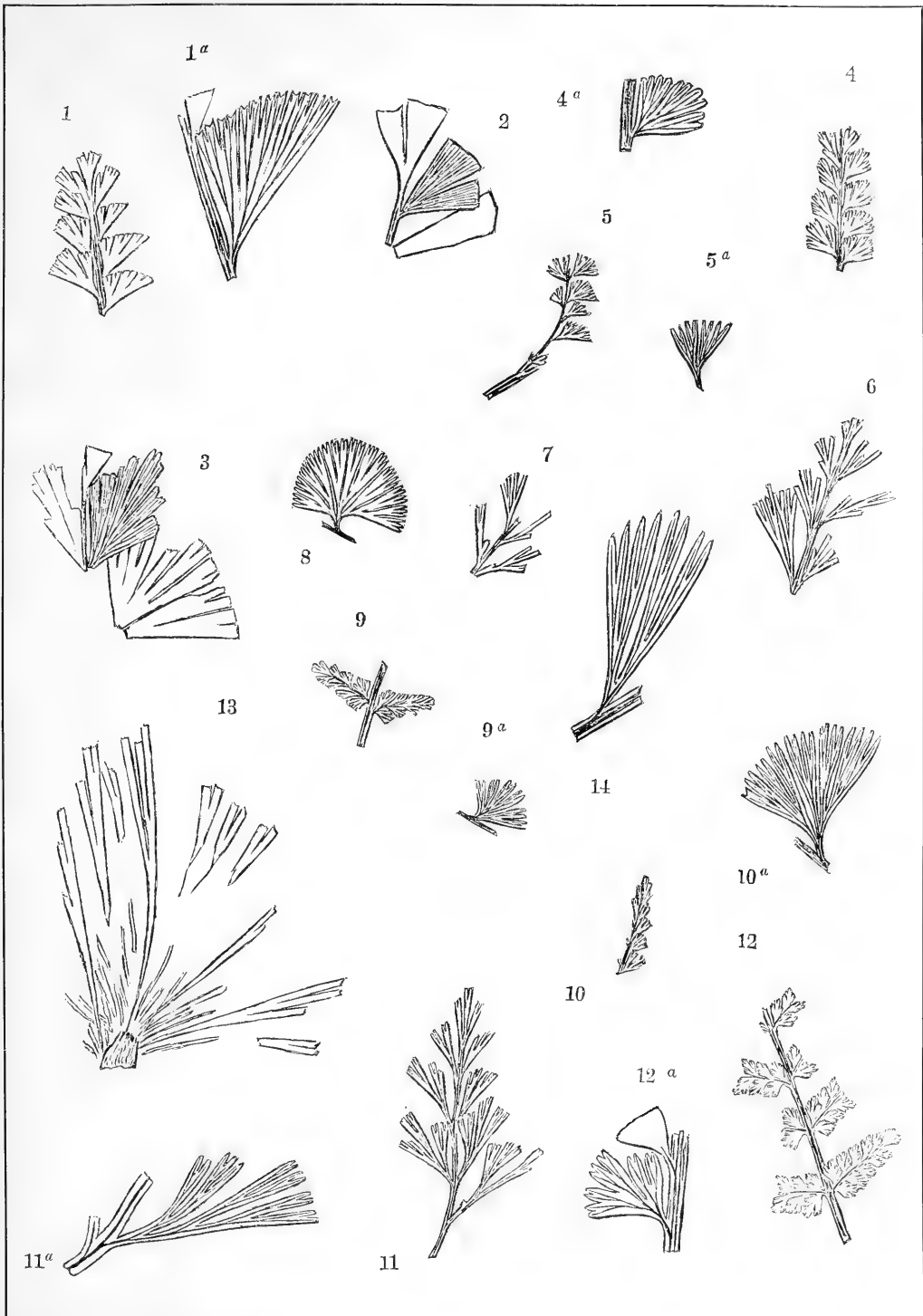

PLATE XCV.

PLATE XCV.

	Page.
FIGS. 1-5. FRENELOPSIS RAMOSISSIMA, sp. nov.	215
1. Portions of branches which have mostly lost the epidermis but still retain the bark	215
2. Stem with branches which retain the epidermis, showing joints unusually long, the branching being much less copious than usual.....	215
3. Portion of a stem which in places retains the epidermis and shows the character of the older leaves.....	215
4. Portion of a stem carrying undeveloped branches and buds.....	215
5. Portion of a stem which for the most part retains the epidermis and contains unusually short joints.....	215

1



2



4



8

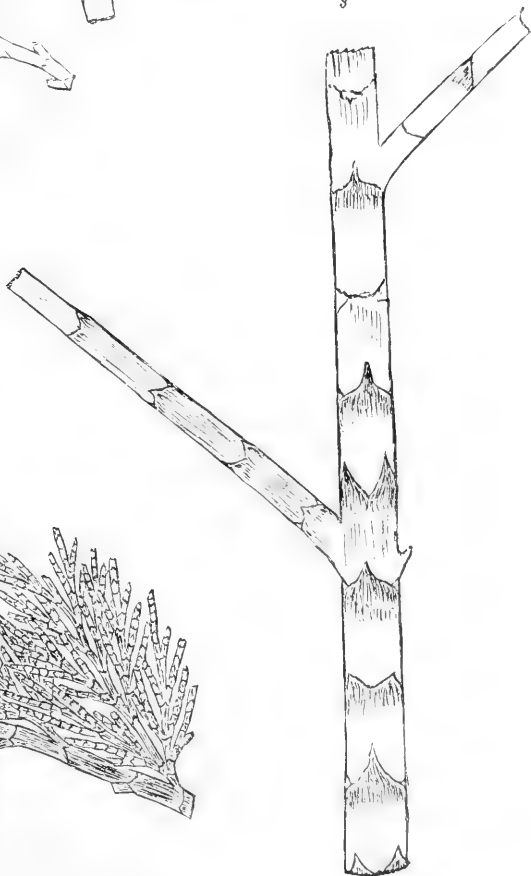

6

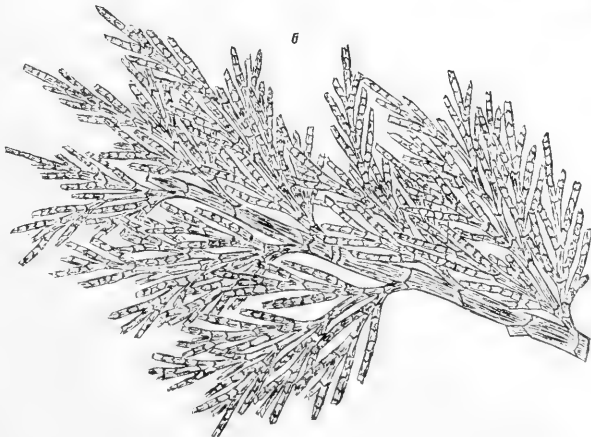

PLATE XCVI.

PLATE XCVI.

	Page.
FIGS. 1-3. <i>FRENELOPSIS RAMOSISSIMA</i> , sp. nov.	215
1. Portion of a decorticated stem with numerous and crowded ultimate branches..	215
2. Portion of a large decorticated stem with comparatively long and remotely placed ultimate branches.....	215
3. Portions of two old and mostly decorticated stems.....	215

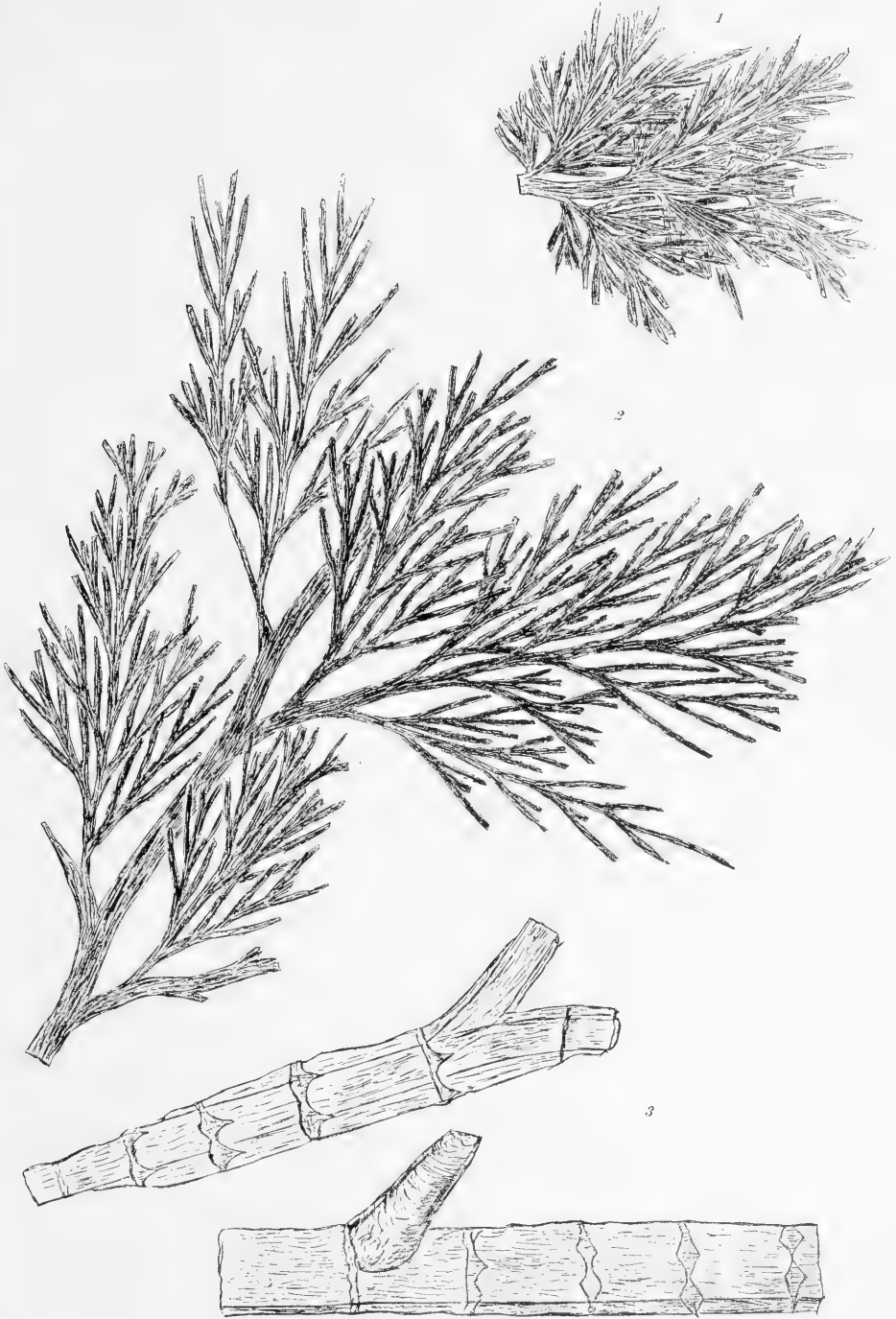

PLATE XCVII.

PLATE XCVII.

	Page.
FIGS. 1-6. FRENELOPSIS RAMOSISSIMA, sp. nov	215
1. Fragment of a large decorticated stem	215
2. Portion of a decorticated branch having ultimate branches unusually small.	215
3. Portion of a decorticated branch with remotely placed ultimate branches	215
4. Fragment of epidermis much magnified, showing the linear arrangement of the tubercles	215
5, 6. Forms of older leaves magnified	215



PLATE XCVIII.

PLATE XCVIII.

	Page.
FIGS. 1-6. FRENELOPSIS RAMOSISSIMA, sp. nov.	215
1. Imprint of a portion of a decorticated branch with ultimate twigs	215
2. Imprint of a large decorticated branch carrying many ultimate branches or twigs..	215
3, 4. Forms of leaves magnified	215
5. Portion of the upper part of a branch carrying very small ultimate branches	215
5 ^a . Penultimate branch with ultimate branches magnified, all decorticated	215
6. Portion of a decorticated branch carrying very small penultimate and ultimate branches	215

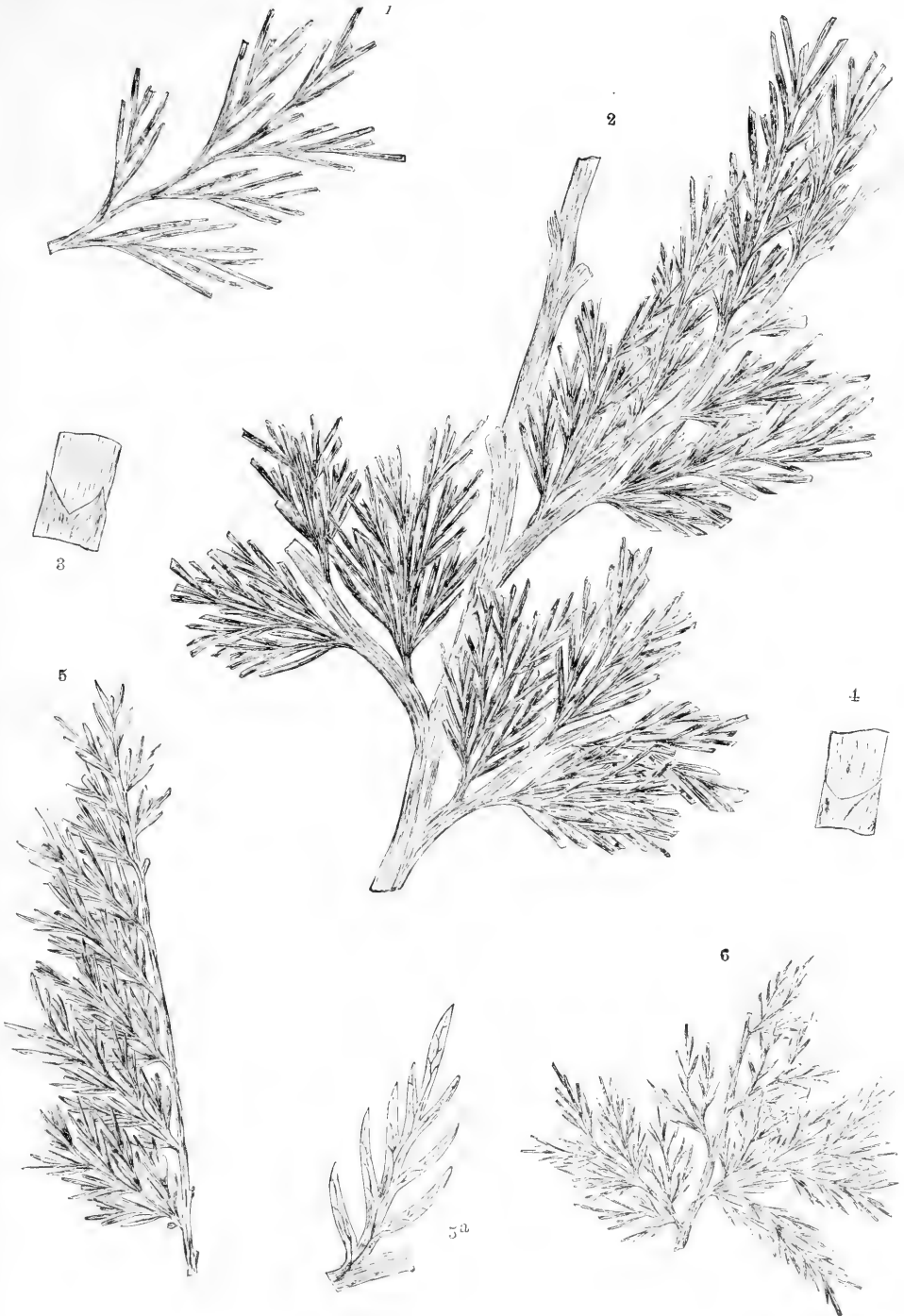

PLATE XCIX.

PLATE XCIX.

	Page.
FIGS. 1-4. FRENELOPSIS RAMOSISSIMA, sp. nov.	215
1. Portion of a stem with numerous buds and undeveloped branches	215
1 ^a . Portion of an undeveloped branch carrying several buds magnified	215
2. Imprint of a branch of considerable size, showing joints and the scar left by a branch.....	215
3. Fragments of several stems decorticated in part	215
4. Portion of a stem with undeveloped branches and buds	215
4 ^a . Undeveloped branch magnified	215
4 ^b . Portion of an undeveloped branch carrying a bud magnified	215

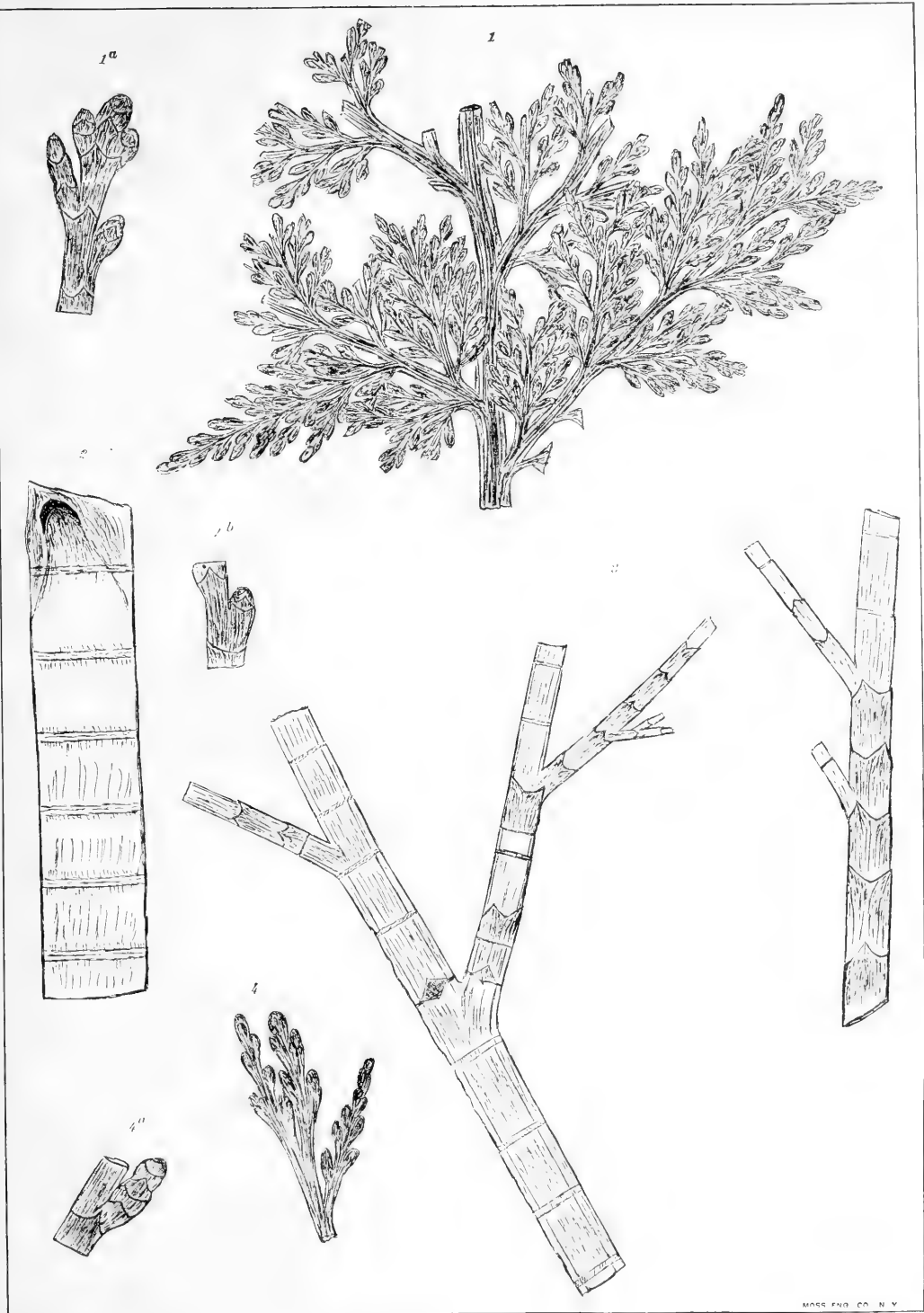

PLATE C.

P L A T E C .

		Page.
FIGS. 1-3.	<i>FRENELOPSIS RAMOSISSIMA</i> , sp. nov	215
	1. Restoration of a subordinate branch, showing the penultimate and ultimate branches	215
	2. Portion of a partially decorticated branch	215
	3. Portion of a stem in a decorticated condition, showing scars left by the leaves on the older decorticated stems, and also the umbellate arrangement of the branches	215
FIG.	4. <i>BRACHYPHYLLUM CRASSICAULE</i> , sp. nov	221
	4. Portion of a branching stem	221



PLATE CI.

P L A T E C I .

		Page.
FIG. 1.	1. FRENELOPSIS RAMOSISSIMA, sp. nov.	215
	1. Fragment of a decorticated branch.....	215
FIGS. 2,3.	LEPTOSTROBUS LONGIFOLIUS, sp. nov.	228
	2. Portions of large leafy branches with the upper parts broken off	228
	3. Summit of a leafy branch.....	228
FIG. 4.	4. LEPTOSTROBUS FOLIOSUS, sp. nov.	230
	4. Portion of a leafy branch with a lateral branch near the summit	230

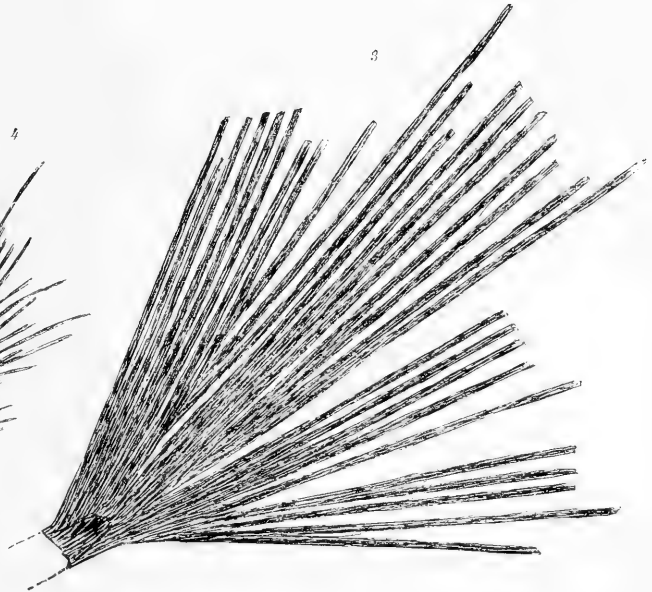
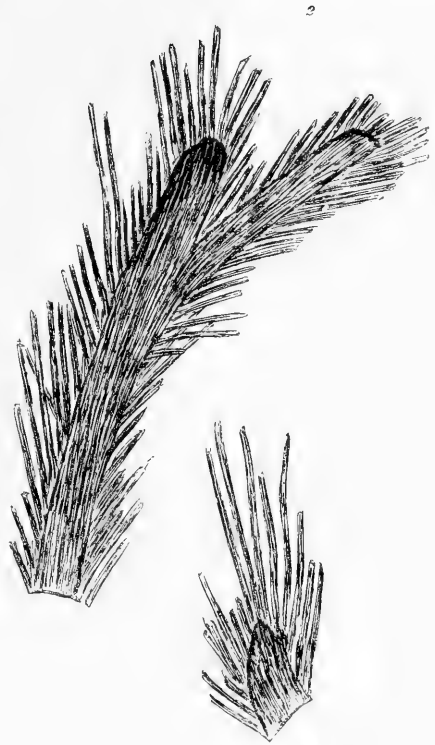

PLATE CII.

PLATE CII.

	Page.
FIGS. 1-4. <i>LEPTOSTROBUS LONGIFOLIUS</i> , sp. nov.	228
1. Several short lateral branches with leaves at the summit in tufts.....	228
2. Summit of a large branch with several short leafy branches, having leaves only at the tips.....	228
3. Portion of a large leafy branch with the upper part broken off.....	228
4. Portion of a bundle of leaves, probably belonging to a short branch.....	228
FIGS. 5, 6. <i>LARICOPSIS BREVIFOLIA</i> , sp. nov.	234
5. Portion of a branch with two naked branchlets.....	234
6. Upper part of a leafy branch.....	234
6 ^a . Leaves of 6 magnified.....	234
FIGS. 7, 8. <i>LARICOPSIS LONGIFOLIA</i> , sp. nov.	233
7. Portion of a large branch nearly bare of leaves.....	233
8. Fragment of a leafy branch.....	233
FIGS. 9, 10. <i>LARICOPSIS ANGUSTIFOLIA</i> , sp. nov.	233
9. Upper part of a branching twig.....	233
10. Fragments of two branches, showing scars on the upper surface.....	235

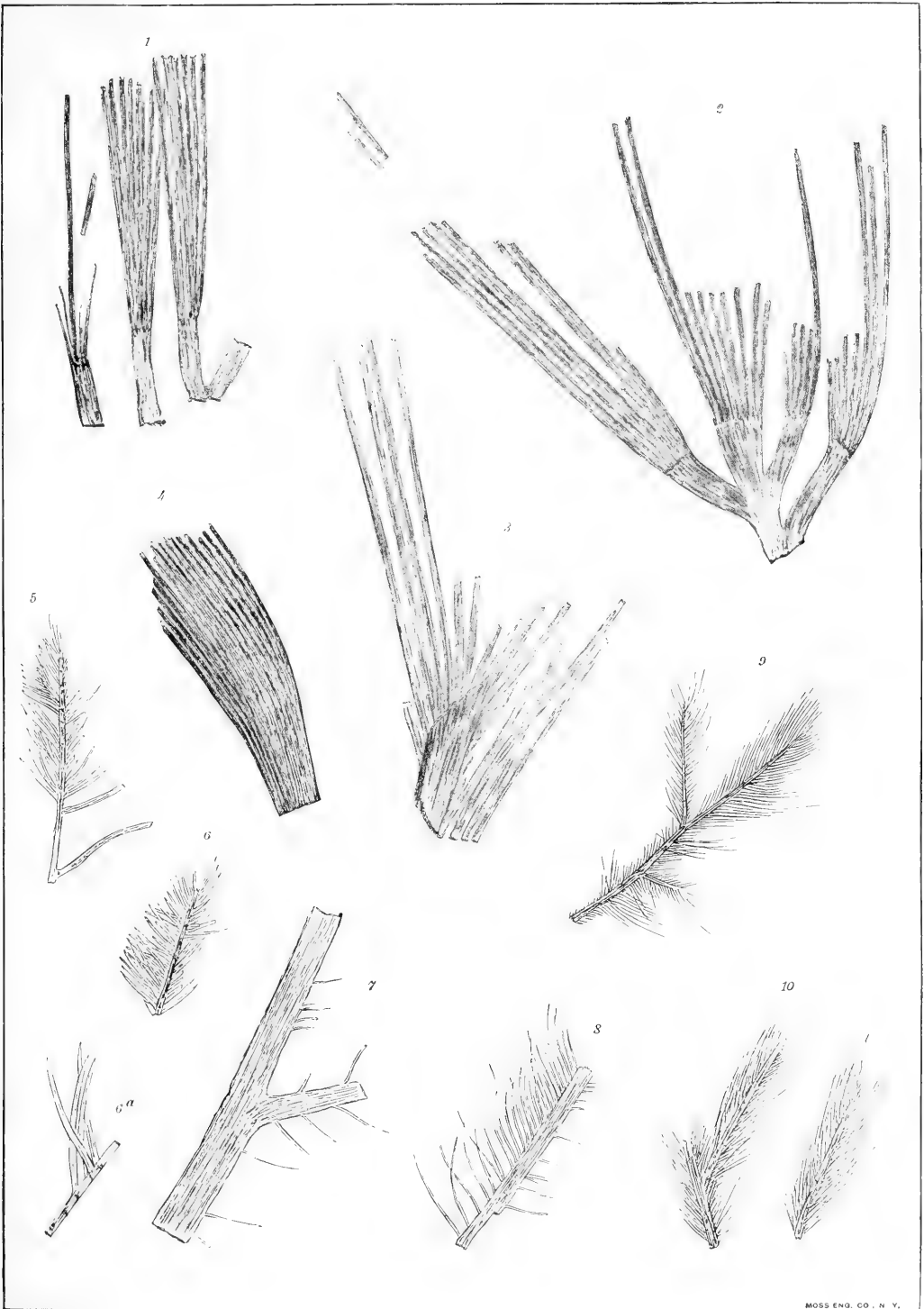

PLATE CIII.

PLATE CIII.

	Page.
FIGS. 1, 4. <i>LARICOPSIS ANGUSTIFOLIA</i> , sp. nov.	233
1. Portion of a branching twig	233
4. Portion of a stem with very narrow leaves	233
FIGS. 2, 3. <i>LARICOPSIS LONGIFOLIA</i> , sp. nov.	233
2. Portion of a branch nearly bare of leaves	233
3. Portion of a stem with leaves of the greatest length	233
FIG. 5. <i>LEPTOSTROBUS FOLIOSUS</i> , sp. nov.	230
5. Fragments of several detached leaves	230
5 ^a . Portion of a leaf magnified	230
FIGS. 6-12. <i>LEPTOSTROBUS LONGIFOLIUS</i> , sp. nov.	228
6. Several detached leaves of large size	228
6 ^a -6 ^b . Portions of different leaves magnified to show the varying apparent nerves	228
7. Fragments of leaves of large size	228
8. Fragments of a number of detached leaves	228
8 ^a . Fragment of a leaf magnified to show the nerves	228
9. Fragment of a very long leaf	228
10-12. Basal portions of leaves	228
10 ^a . Portion of 10 magnified to show the nerves	228

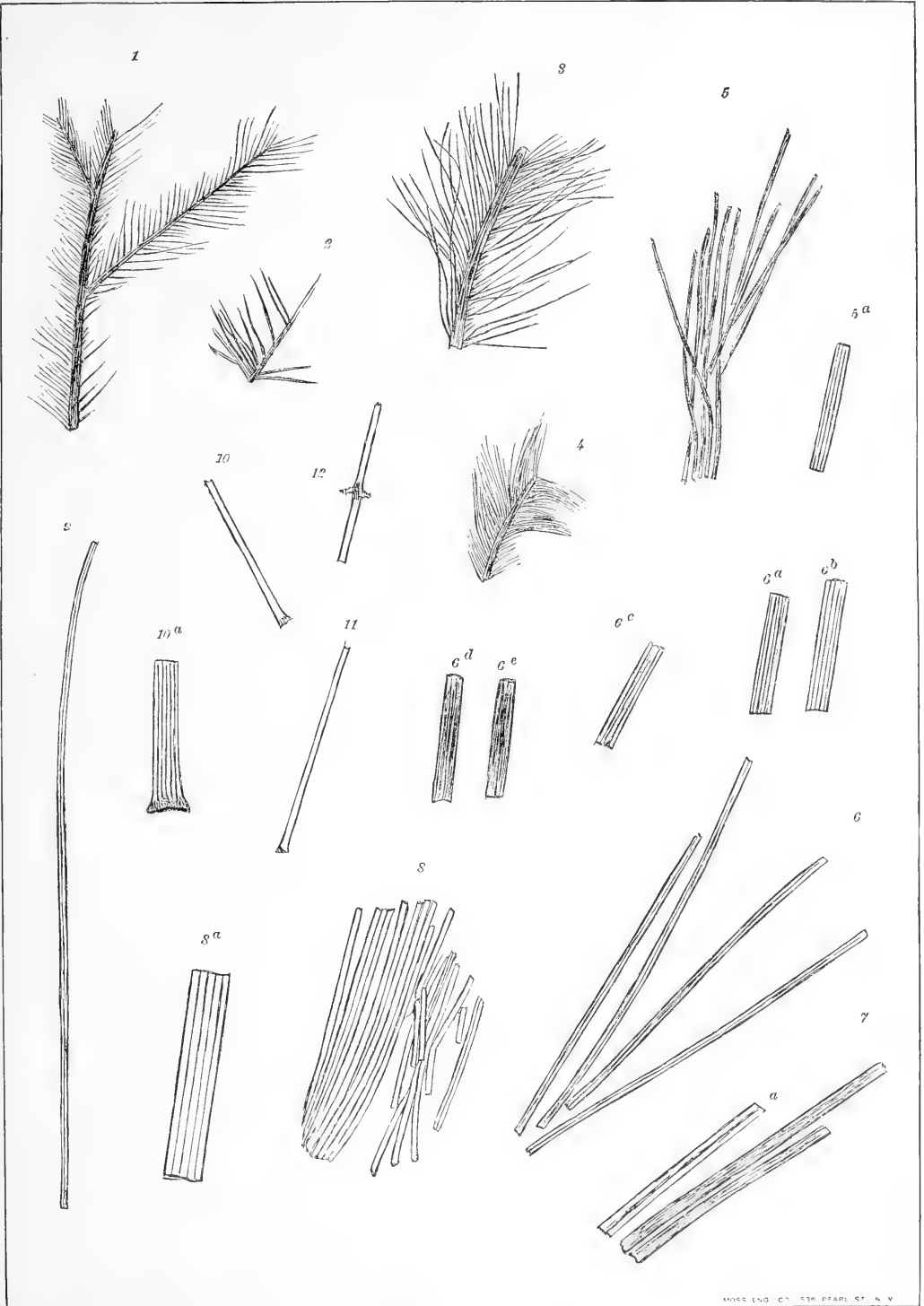

PLATE CIV.

PLATE CIV.

	Page.
FIG. 1. LEPTOSTROBUS FOLIOSUS, sp. nov.....	230
1. Fragments of a number of detached leaves.....	230
FIGS. 2, 3. CEPHALOTAXOPSIS RAMOSA, sp. nov.....	237
2. Fragments of a very large branch.....	237
3. Portion of an ultimate branch with small leaves.....	237
FIGS. 4, 5. CEPHALOTAXOPSIS MAGNIFOLIA, sp. nov.....	236
4. Fragment of an ultimate branch with small leaves.....	236
5. Fragment of a branch with leaves of the largest size.....	236
FIG. 6. LEPTOSTROBUS LONGIFOLIUS, sp. nov.....	228
6. Basal portion of a leaf apparently attached in a clasping manner.....	228

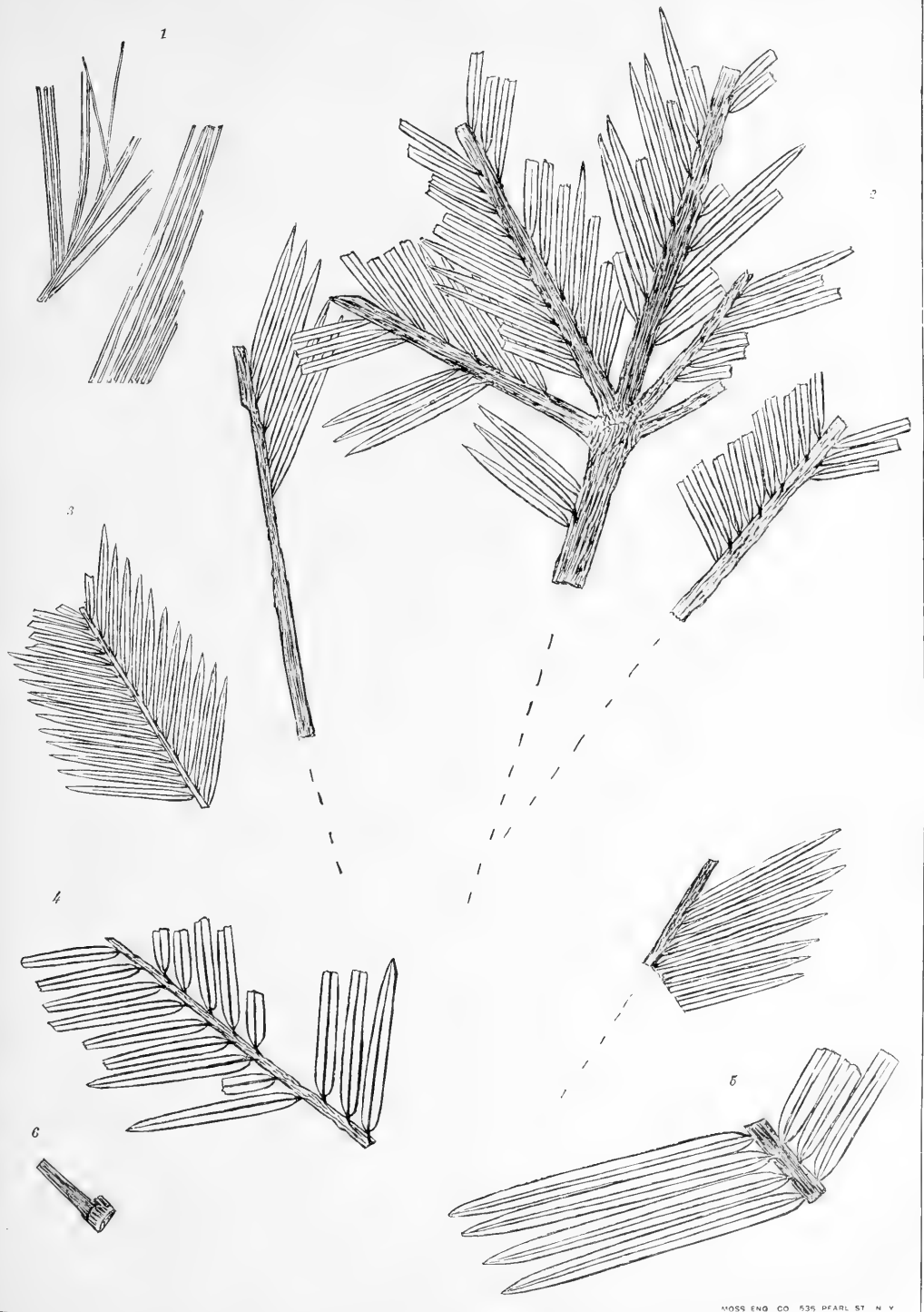
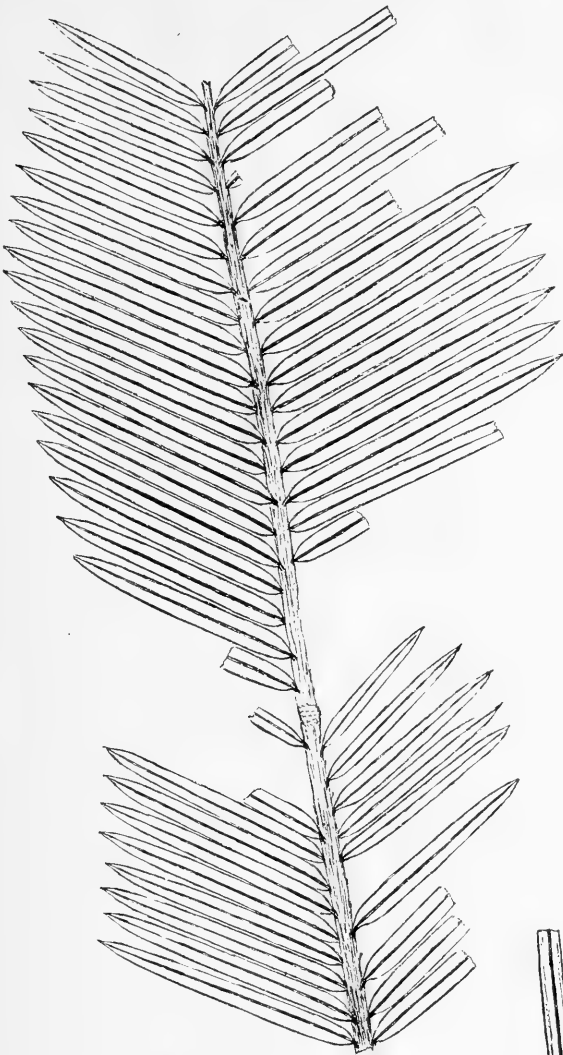

PLATE CV.

PLATE CV.

	Page.
FIGS. 1, 2, 4. CEPHALOTAXOPSIS MAGNIFOLIA, sp. nov.	236
1. Fragment of a very large branch with scars of bud-scales and unusually small leaves beneath them	236
1 ^a . Basal portions of leaves magnified.....	236
1 ^b . Tip of a leaf magnified.....	236
2. Summit of an ultimate twig, showing terminal leaflet.....	236
4. Portion of a branch with leaves of the largest size	236
FIG. 3. CEPHALOTAXOPSIS BREVI-FOLIA, sp. nov.	238
3. Portion of a branch showing leaves of the largest size.....	238

1



2

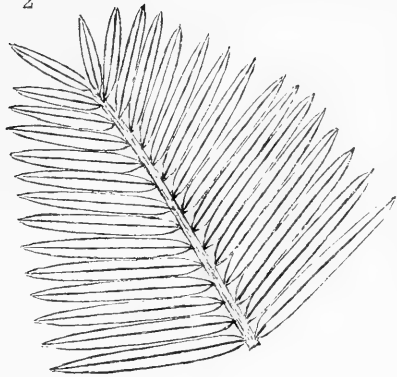

1^b



3

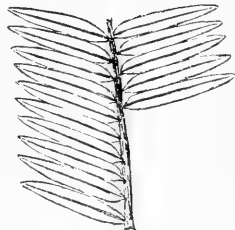

1^a



4

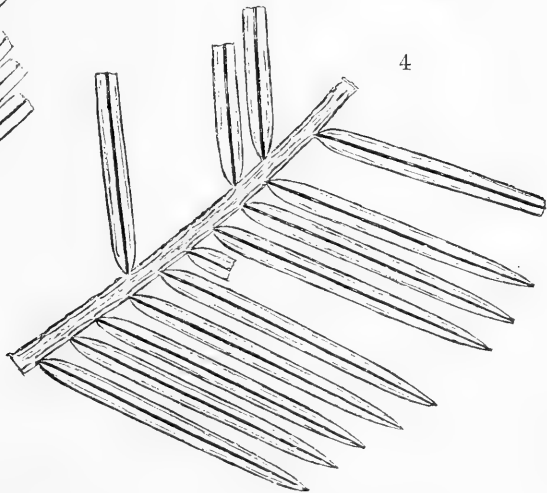
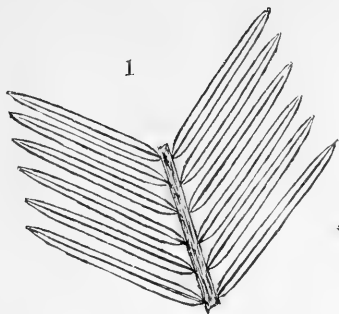

PLATE CVI.

P L A T E C V I.

	Page.
FIGS. 1, 3. <i>CEPHALOTAXOPSIS MAGNIFOLIA</i> , sp. nov.	236
1. Portion of an ultimate branch with small leaves	236
1 ^a . Leaf magnified, showing wrinkling.....	236
3. Fragment with large leaves.....	236
FIGS. 2, 4. <i>CEPHALOTAXOPSIS RAMOSA</i> , sp. nov.	237
2. Portions of several detached ultimate branches	237
4. Fragment of an ultimate branch with leaves of the smallest size	237
4 ^a . Leaf magnified	237
FIG. 5. <i>CEPHALOTAXOPSIS BREVIFOLIA</i> , sp. nov.	238
5. Fragment of a branching twig having leaves of medium size	238



1

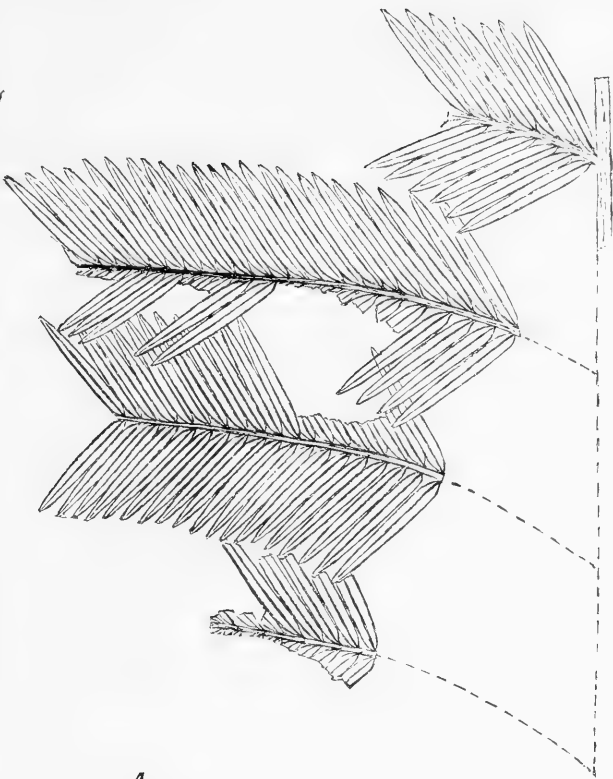

2

1^a

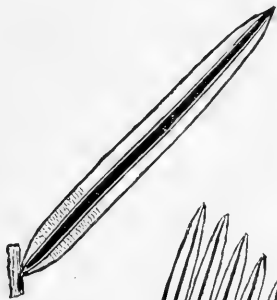

3

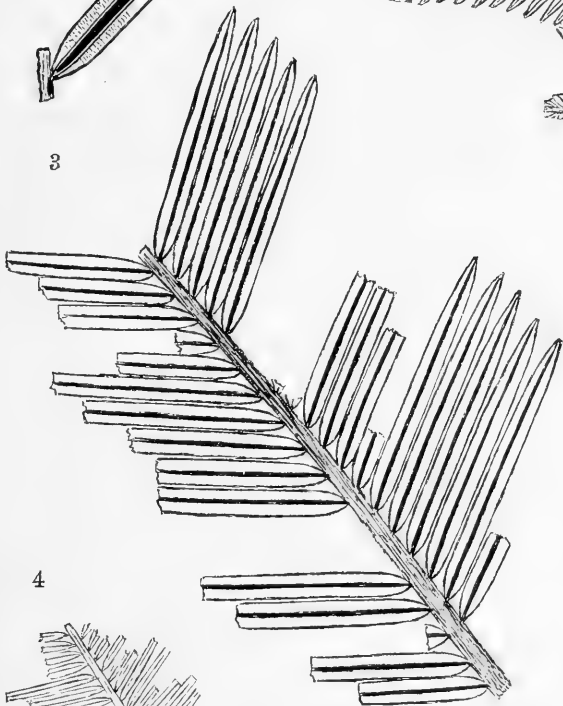

4

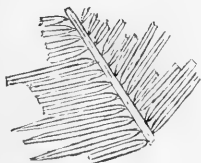

5



4^a

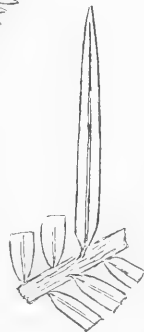

PLATE CVII.

PLATE CVII.

	Page.
FIGS. 1, 2, 4. CEPHALOTAXOPSIS MAGNIFOLIA, sp. nov	236
1. Portion of an ultimate branch with small leaves.....	236
2. Fragments of branches with small leaves	236
4. Portion of a branch with large leaves	236
4 ^a . Basal portion of a leaf magnified.....	236
FIG. 3. CEPHALOTAXOPSIS RAMOSA, sp. nov	237
3. Portion of a twig showing whorl of branches.....	237
FIG. 5. CEPHALOTAXOPSIS BREVIFOLIA, sp. nov	238
5. Portion of a twig with leaves of medium size.....	238
5 ^a . Leaves of 5 magnified	238

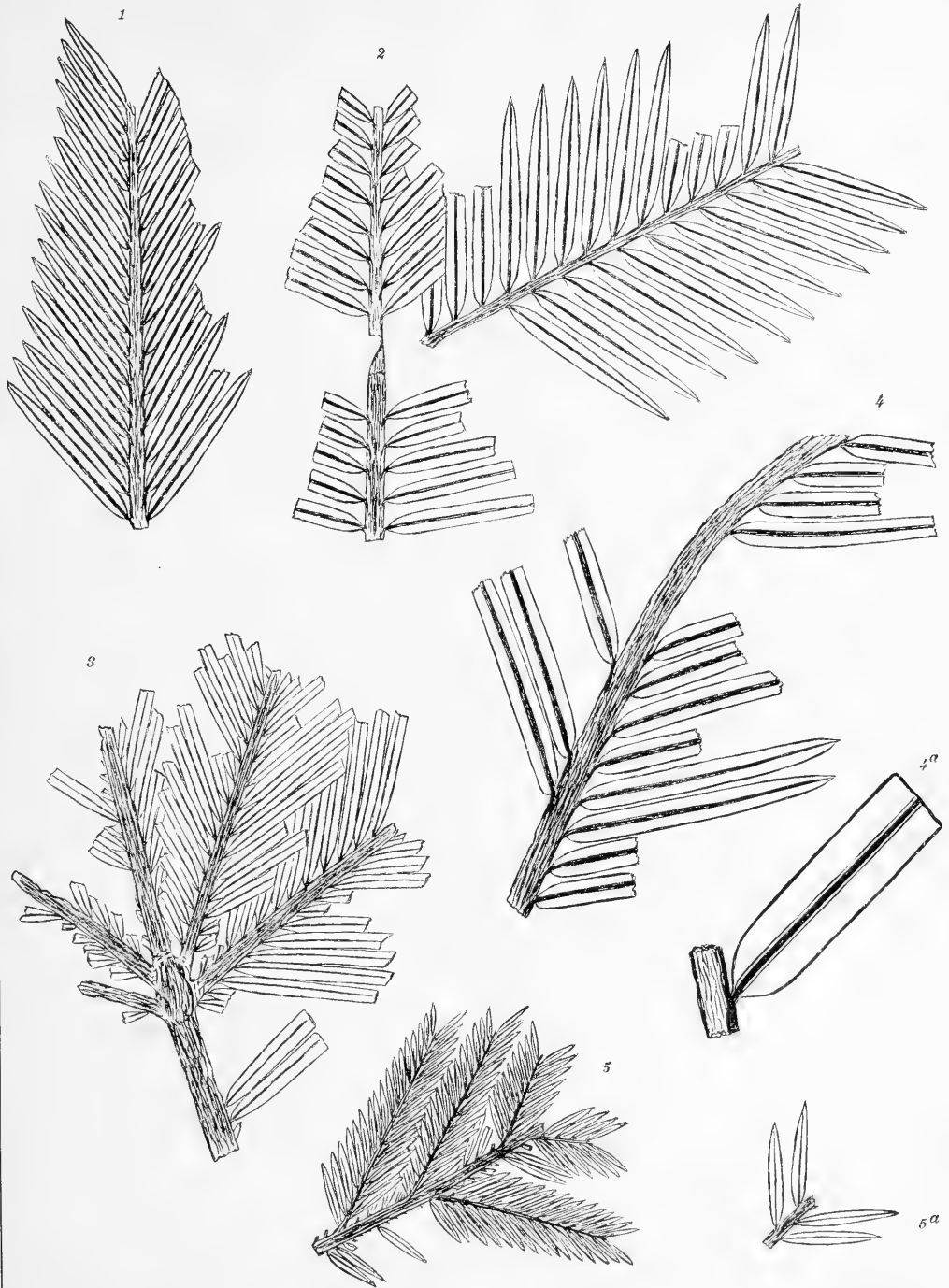

PLATE CVIII.

PLATE CVIII.

		Page.
FIGS. 1,3,4.	CEPHALOTAXOPSIS MAGNIFOLIA, sp. nov.	236
	1. Portion of a branching twig with small leaves.....	236
	3. Portion of an ultimate branch with leaves of large size.....	236
	4. Portion of an ultimate branch with leaves of the largest size.....	236
FIG.	2. CEPHALOTAXOPSIS RAMOSA, sp. nov.	237
	2. Fragments of a branching stem	237
FIG.	5. CEPHALOTAXOPSIS MICROPHYLLA, sp. nov.	238
	5. Fragment of a twig with leaves of medium size	238

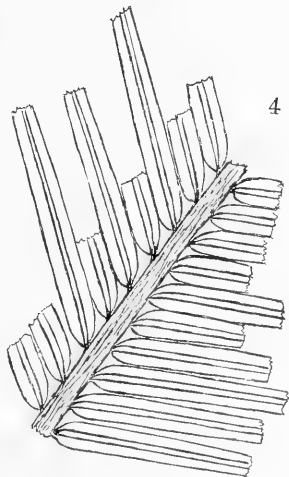
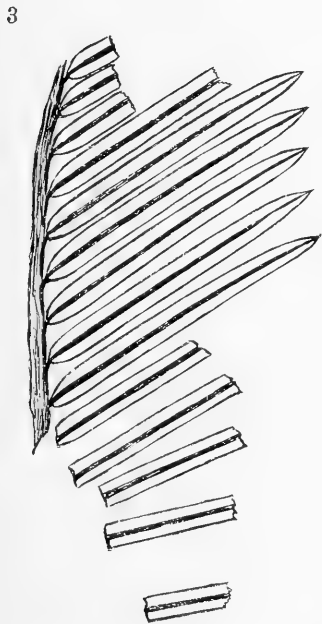
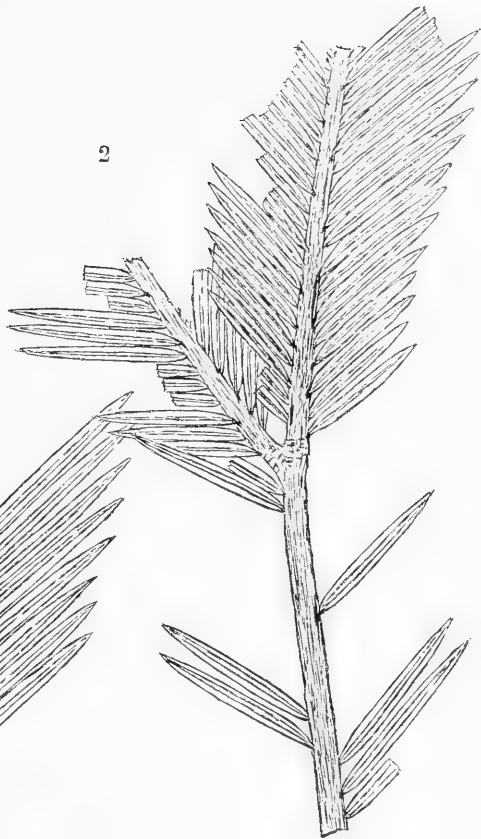
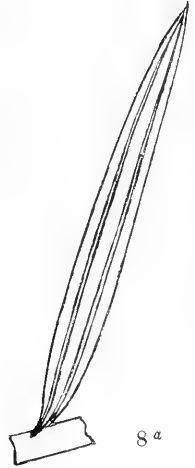
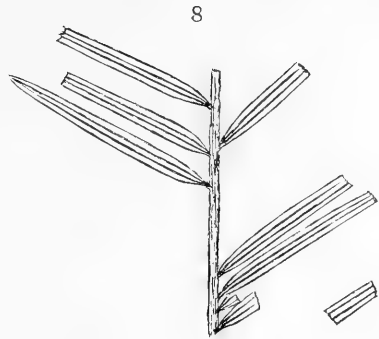

PLATE CIX.

PLATE CIX.

		Page.
FIGS.	1-7. <i>BRACHYPHYLLUM CRASSICAULE</i> , sp. nov.	221
	1. Portion of a stem with remotely placed penultimate branches.....	221
	1 ^a . Portion of 1 magnified	221
	1 ^b . A portion of 1 magnified, showing granulation on the leaves	221
	2. Upper part of a penultimate branch.....	221
	3. Fragment of a bifurcating branch.....	221
	4. Upper part of a penultimate branch, showing a common arrangement of the ultimate branches in this part.....	221
	4 ^a . Portion of 4 magnified	221
	5. Upper part of a small penultimate branch; a common form.....	221
	6. Summit of a penultimate branch carrying a partially destroyed cone.....	221
	7. Upper part of a large penultimate branch.....	221
FIG.	8. <i>TORREYA VIRGINICA</i> , sp. nov.	234
	8. Portion of an ultimate branch.....	234
	8 ^a . Leaf of 8 magnified	234
FIG.	9. <i>CEPHALOTAXOPSIS MICROPHYLLA</i> , sp. nov.	238
	9. Upper part of a leafy branching twig	238



1

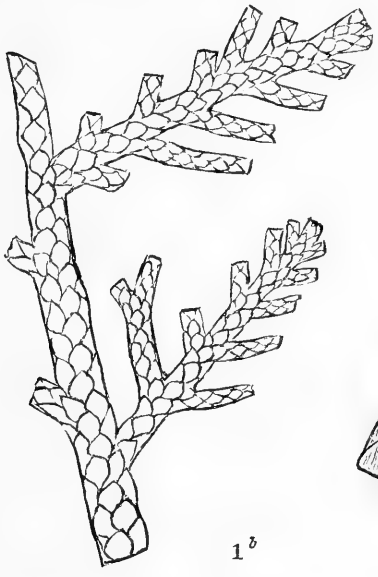

3



7



2



1^b

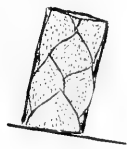

6



4



5



PLATE CX.

PLATE CX.

	Page.
FIGS. 1-3. BRACHYPHYLLUM CRASSICAULE, sp. nov.	221
1. Portion of a large decorticated branch, showing only the imprint of the decorticated material.	221
2. Upper portion of a penultimate branch.	221
3. Portion of a bifurcating branch.	221
3 ^a . Part of 3 magnified.	221
FIG. 4. BRACHYPHYLLUM PARCERAMOSUM, sp. nov.	223
4. Fragments of several branches, some of them detached and overlapping, showing dichotomous mode of branching.	223

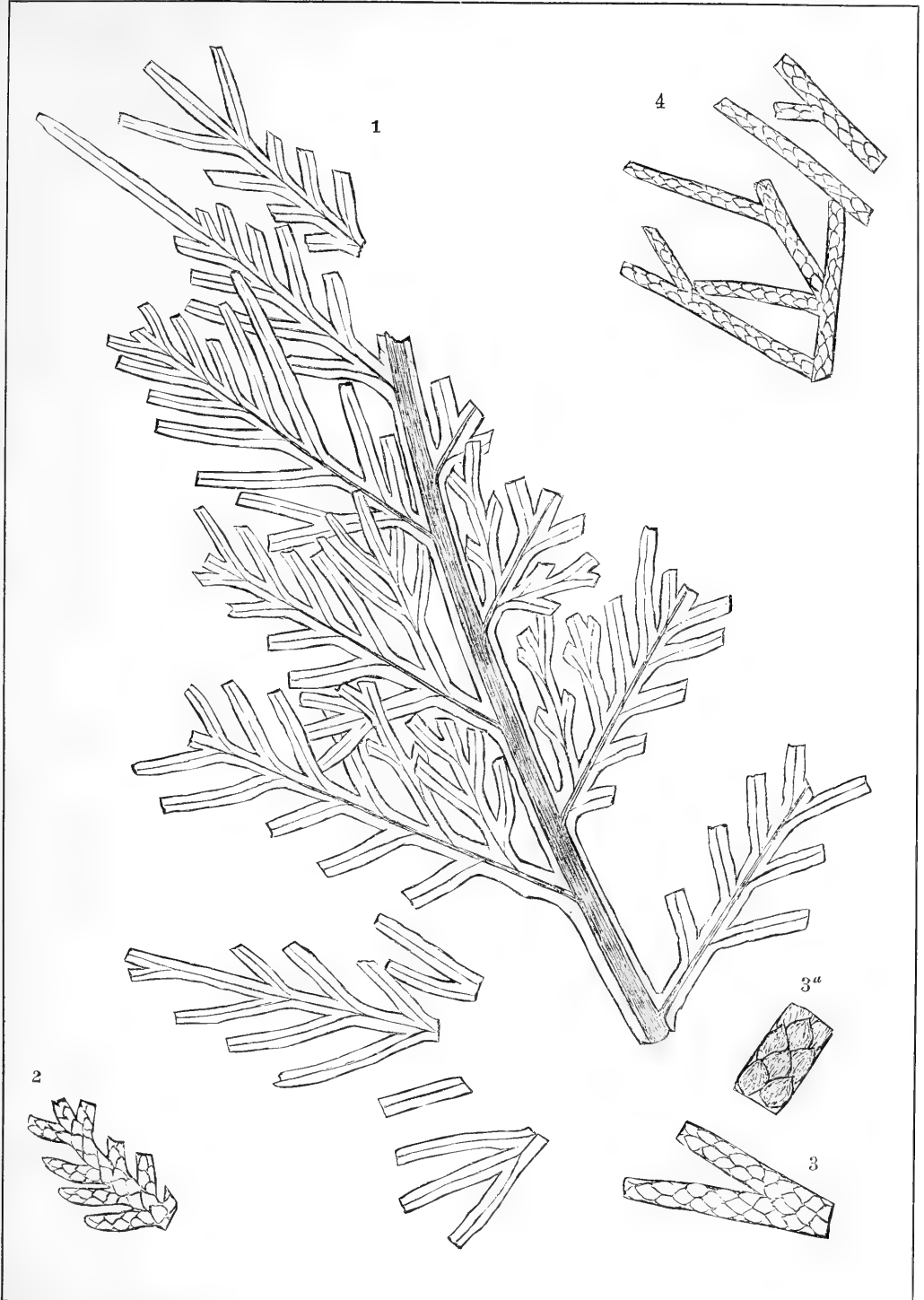

PLATE CXI.

PLATE CXI.

	Page.
FIGS. 1-5. FRENELOPSIS PARCERAMOSA, sp. nov.	218
1. Portion of a stem with large branches, partly restored.....	218
2. Portion of a stem with remote branches.....	218
3. Fragment of an ultimate branch of medium size.....	218
3 ^a . Portion of 3 magnified.....	218
4. Portion of a small stem with small and remote branches, one of them branching again.....	218
5. Small fragment of an ultimate branch of medium size.....	218
FIGS. 6, 7. BRACHYPHYLLUM CRASSICAULE, sp. nov.....	221
6. Fragment of a large branch.....	221
7. Fragment of a stem of medium size with several branches.....	221
7 ^a . A portion of 7 magnified	221

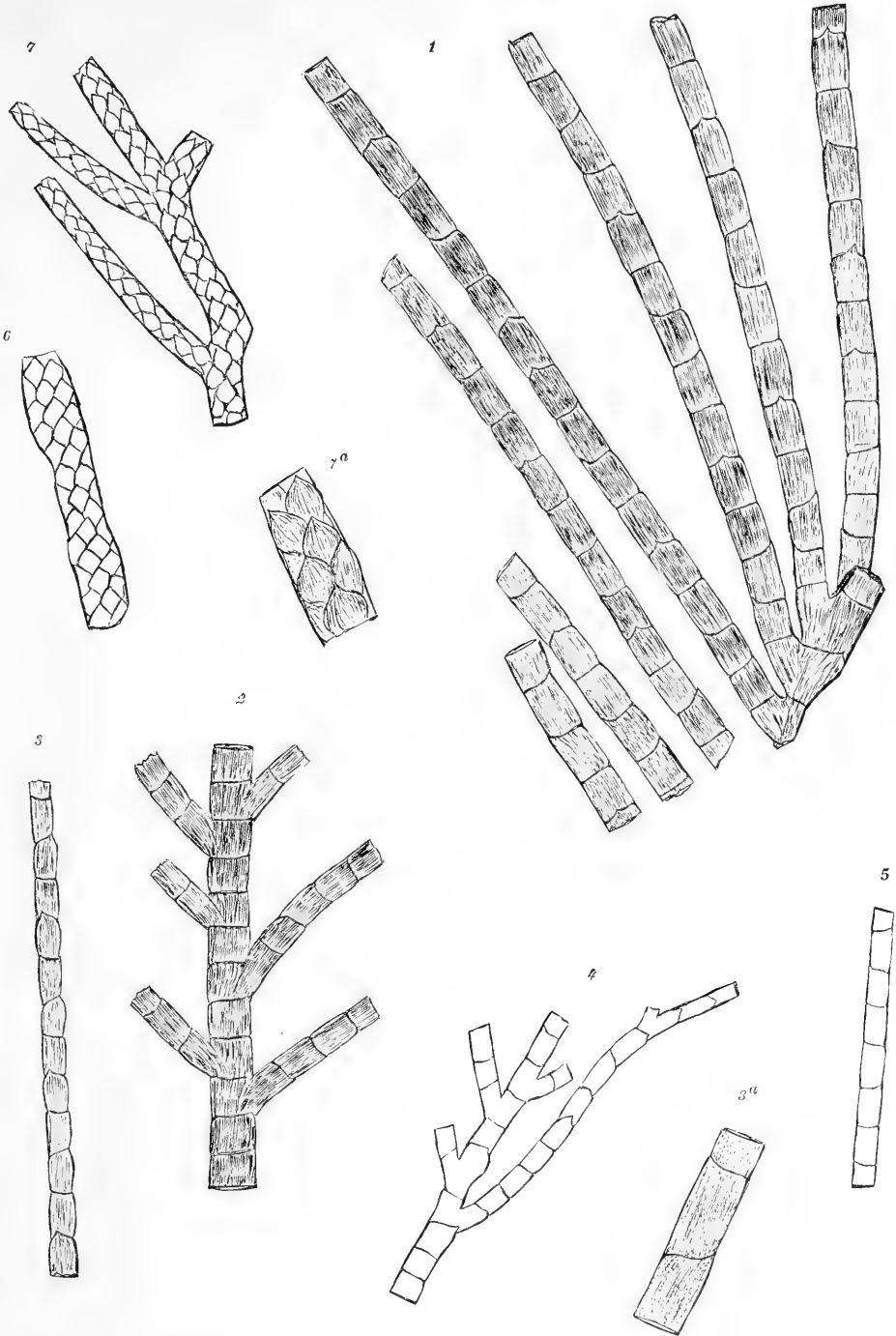

PLATE CXII.

PLATE CXII.

	Page.
FIGS. 1-5. <i>FRENELOPSIS PARCERAMOSA</i> , sp. nov.	218
1. Small portion of two branches of medium size.	218
2. Fragment of a rather large ultimate branch.	218
3. Unusually long fragment of an ultimate branch.	218
3 ^a . Portion of 3 magnified to show the arrangement of the epidermal tubercles in lines.	218
4. Portion of an ultimate branch having the greatest width seen.	218
5. Portions of two stems, showing an umbellate arrangement of the branches.	218
FIGS. 6-8. <i>BRACHYPHYLLUM CRASSICAULE</i> , sp. nov.	221
6. Upper portion of a penultimate branch.	221
7. Portion of a stem with short ultimate branches.	221
8. Upper part of a penultimate stem or branch, showing a bifurcation in two of the ultimate branches.	221
FIGS. 9-11. <i>SEQUOIA CYCADOPSIS</i> , sp. nov.	243
9. Portions of twigs with leaves of the largest size.	243
9 ^a . Leaf magnified.	243
10. Portion of a twig with leaves of the largest size magnified, showing the keeled midrib on the under side.	243
11. Portion of a twig showing small-sized leaves.	243
11 ^a . Leaf of 11 magnified.	243

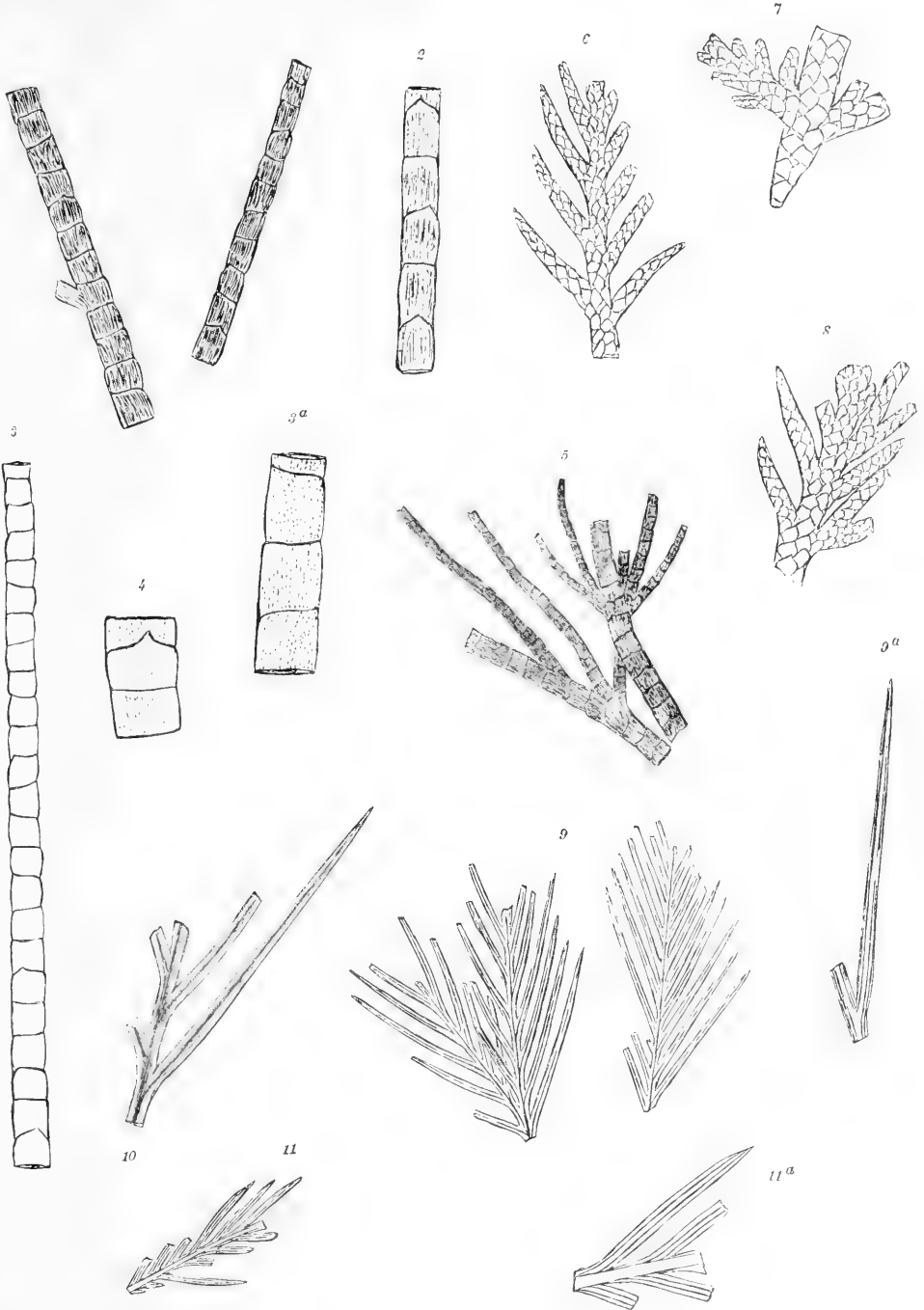

PLATE CXIII.

PLATE CXIII.

	Page.
FIGS. 1-3. <i>SEQUIA CYCADOPSIS</i> , sp. nov	243
1. Portions of twigs near the ends with leaves of the smallest size	243
1 ^a . Leaves magnified	243
2. Portion of a twig with small leaves	243
2 ^a . Leaves magnified	243
3. Portion of the upper part of a twig with narrow, long leaves	243
FIG. 4. <i>TORREYA FALCATA</i> , sp. nov	235
4. Portion of a twig with small leaves	235
4 ^a . Leaves magnified	235
FIGS. 5, 6. <i>ATHROTAXOPSIS EXPANSA</i> , sp. nov	241
5. Fragment of a widely spreading branch	241
5 ^a . Fragment magnified to show the lateral leaves, those on the upper face of the twigs having been removed by maceration	241
5 ^b . Portion of the ultimate twigs magnified, showing all the leaves in place	241
6. Fragment of a branch showing all the leaves retained	241

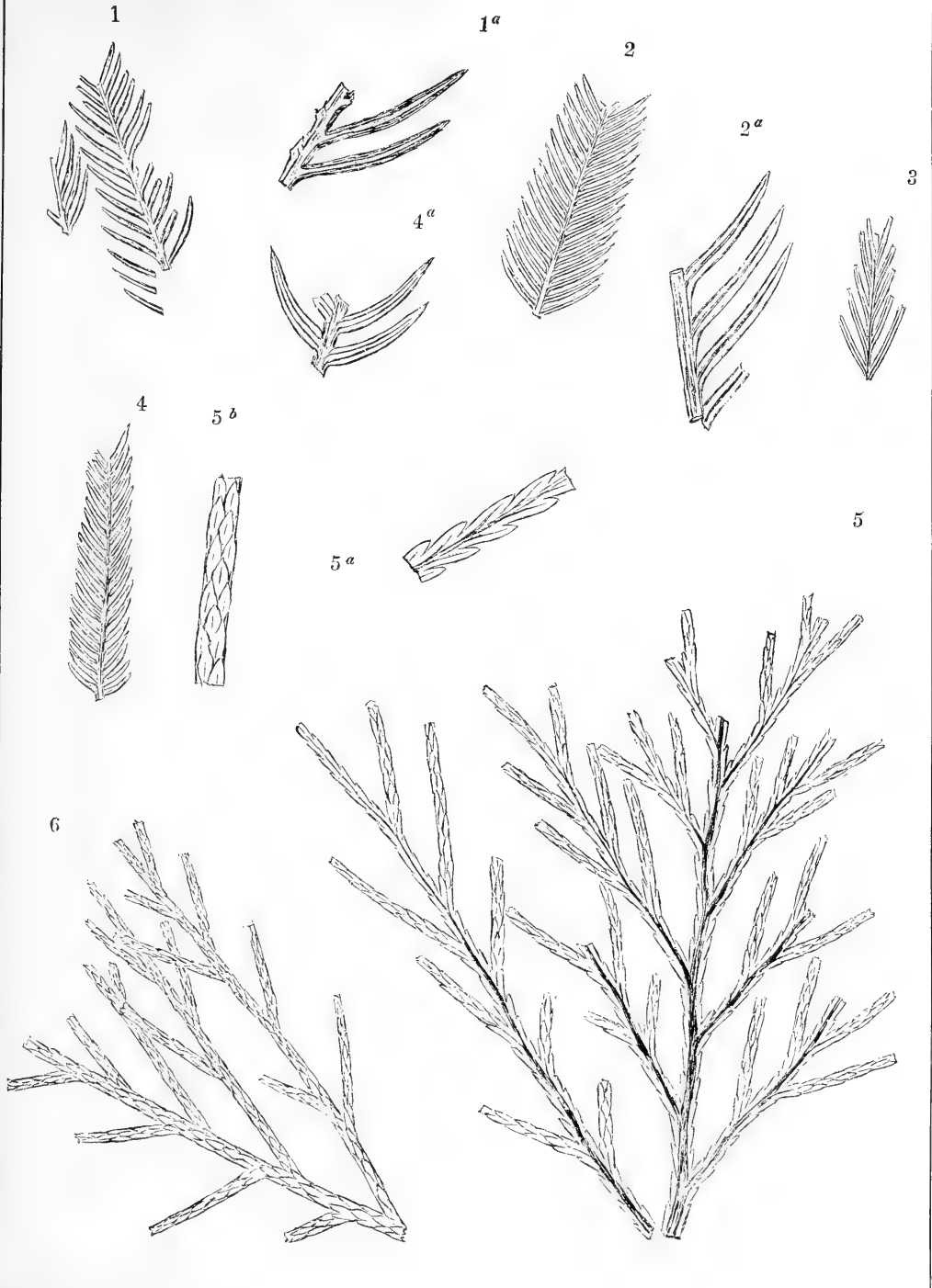

PLATE CXIV.

PLATE CXIV.

	Page.
FIGS. 1-3. <i>ATHROTAXOPSIS GRANDIS</i> , sp. nov	240
1. Fragments of a large branch, showing twigs which contain cones in the lower portions and leafy branches without cones in the upper parts	240
2. Fragments of very long slender branches containing leafy twigs	240
3. Fragment of a branch associated with several detached cones.....	240
3*. Scale of a cone magnified	240
FIGS. 4, 5. <i>ATHROTAXOPSIS TENCICHAULIS</i> , sp. nov	241
4. Fragment of a branch carrying very small ultimate twigs	241
4*. Portion of an ultimate twig magnified	241
5. Fragment of a twig which branches with unusual copiousness, and which has the ultimate twigs more crowded than is common	241



5

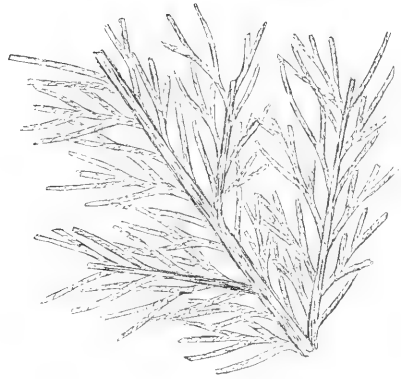

2

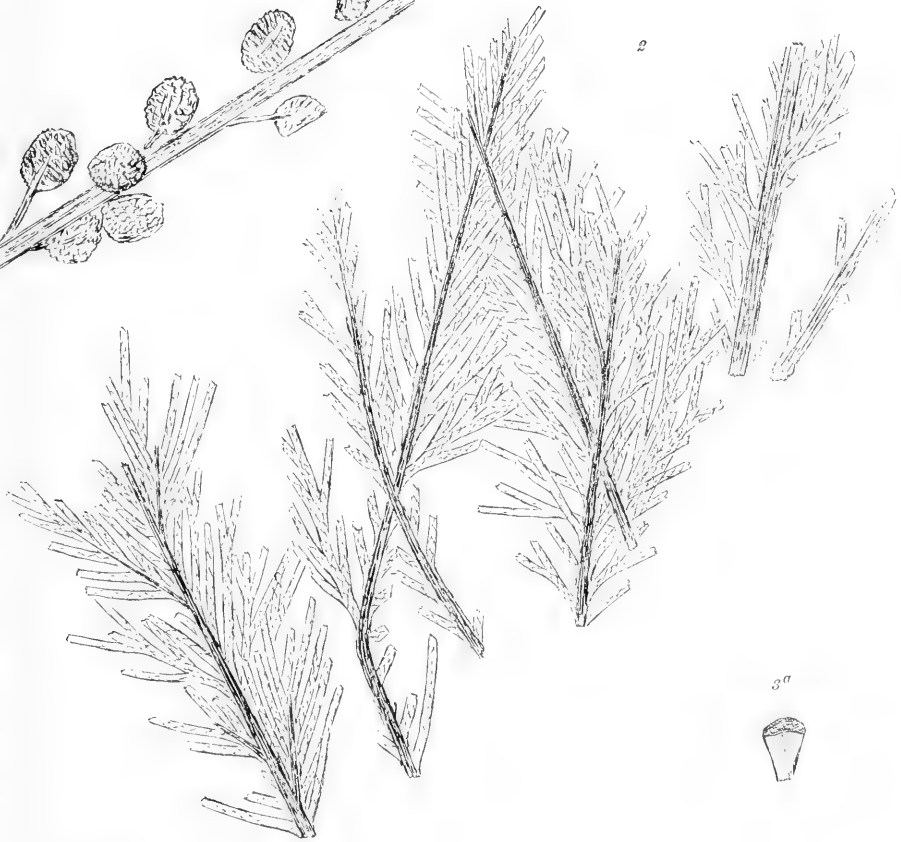

3^a



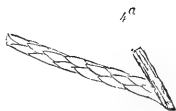
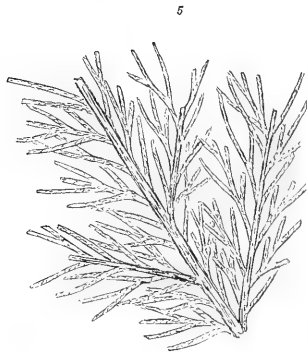

PLATE CXV.

PLATE CXV.

		Page.
FIGS. 1, 3.	<i>ATHROTAXOPSIS PACHYPHYLLA</i> , sp. nov.	242
	1. Upper part of a small branch	242
	1 ^a . Portion of an ultimate twig magnified	242
	3. Portion of a small copiously branching twig	242
FIG. 2.	<i>ATHROTAXOPSIS EXPANSA</i> , sp. nov.	241
	2. Portions of a widely expanded branch	241
FIG. 4.	<i>ATHROTAXOPSIS TENUICAULIS</i> , sp. nov.	241
	4. Fragments of a branching stem with ultimate twigs of the largest size.....	241
	4 ^a . Portion of an ultimate twig magnified	241

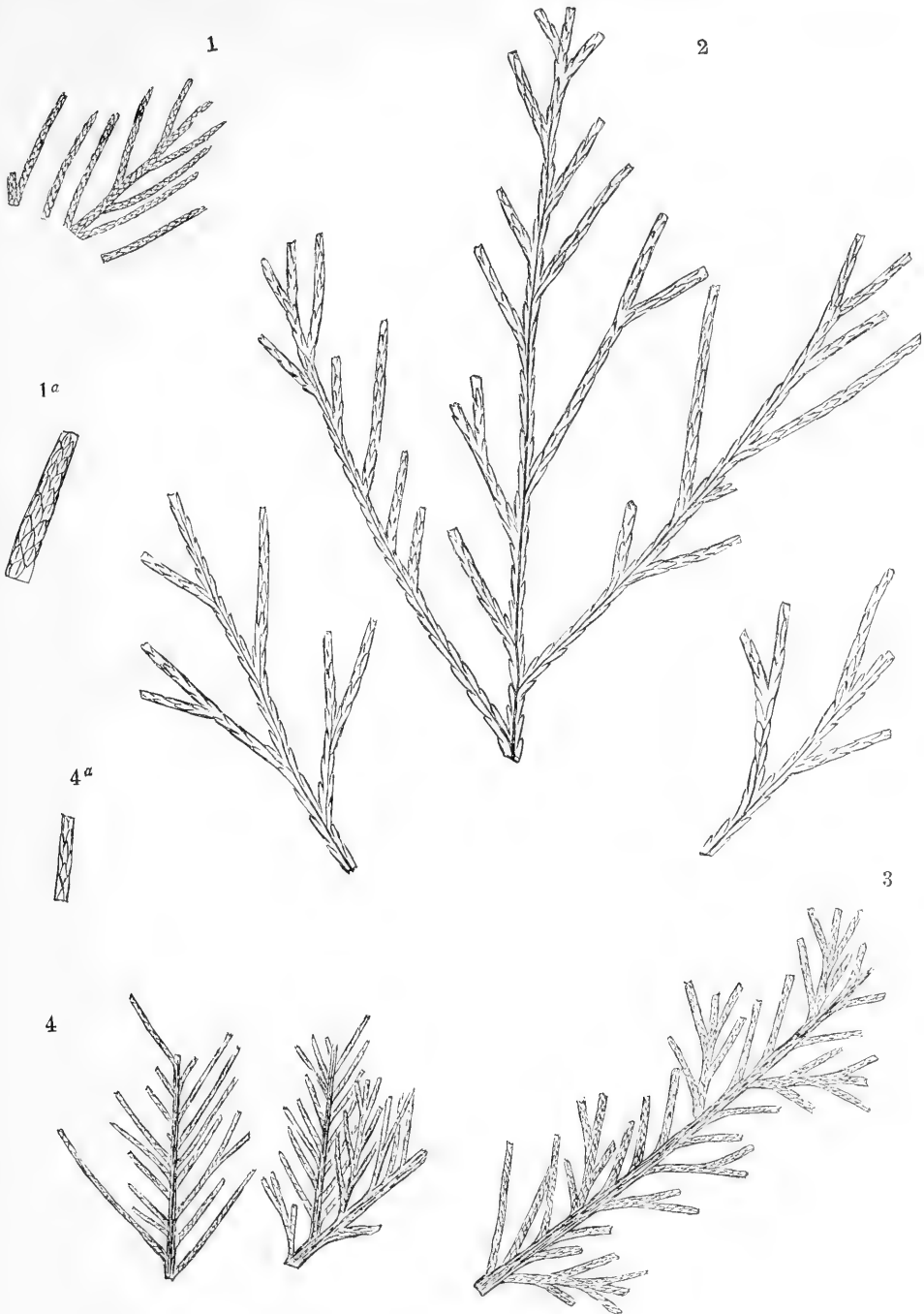

PLATE CXVI.

PLATE CXVI.

		Page.
FIGS. 1-4.	ATHROTAXOPSIS GRANDIS, sp. nov.	240
	1. Fragments of a large branch bearing cones only	240
	2. Fragment of a comparatively small cone-bearing branch. The uppermost minor branch shows that these do not always lie in the same plane.....	240
	2 ^a . Scale of a cone of 2 magnified.....	240
	3, 4. Portions of small branches with ultimate leafy twigs. These, as shown in 3, do not lie strictly in one plane	240
	3 ^a . Portion of 3 magnified	240
FIG.	5. ATHROTAXOPSIS EXPANSA, sp. nov.	241
	5. Portion of a twig with remote leafy branches	241
FIG.	6. ATHROTAXOPSIS TENUICAILIS, sp. nov.	241
	6. Termination of two penultimate branches, showing at the ends ultimate twigs similar to those lower down on the penultimate branches	241
FIG.	7. SEQUOIA, sp. ?	248
	7. Cross section of a cone flattened by pressure and retaining only a few scales.....	248

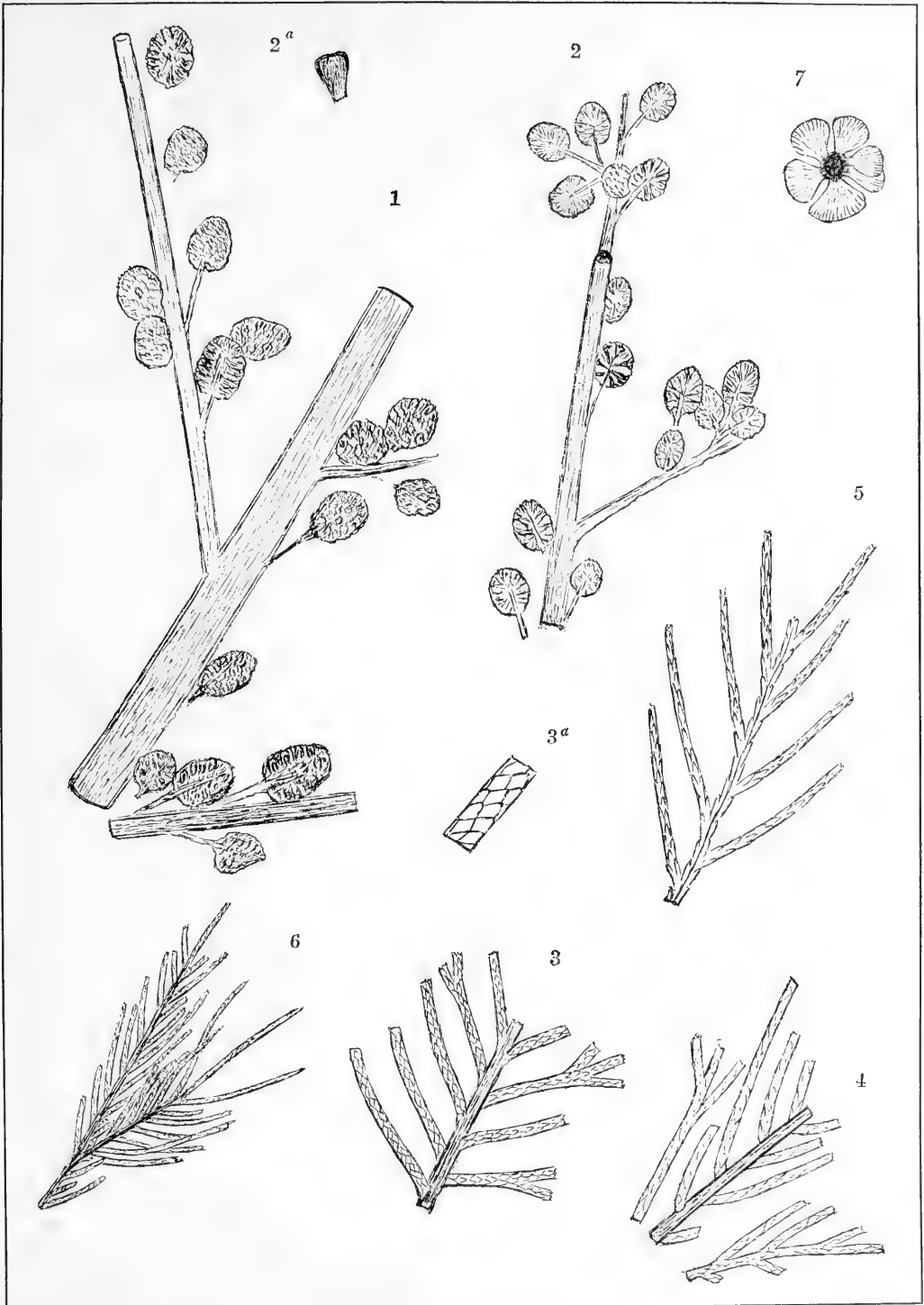

PLATE CXVII.

PLATE CXVII.

	Page.
FIGS. 1,3-5. <i>ATHROTAXOPSIS PACHYPHYLLA</i> , sp. nov	242
1. Portion of a twig with remote ultimate branches.....	242
3. Portion from near the tip of a penultimate twig.....	242
3 ^a , 3 ^b . Portions of 3 magnified.....	242
4. Fragment of a penultimate branch	242
4 ^a . Portion of 4 magnified	242
5. Fragment of a branch with slender ultimate twigs partially decorticated.....	242
5 ^a . Portion of 5 magnified.....	242
FIG. 2. <i>ATHROTAXOPSIS TENUICAULIS</i> , sp. nov.....	241
2. Fragment of a branch with crowded ultimate twigs of the largest size.....	241
2 ^a . Portion of 2 magnified.....	241
FIG. 6. <i>ATHROTAXOPSIS EXPANSA</i> , sp. nov	241
6. Fragment of a branch showing a distorted cone	241
FIG. 7. <i>SEQUOIA SUBULATA</i> Heer	245
7. Fragment of an old twig showing leaves unusually narrow and remote.....	245
7 ^a . Leaf magnified.....	245
FIG. 8. <i>SEQUOIA REICHENBACHI</i> (Geib.) Heer, var. <i>LONGIFOLIA</i>	244
8. Fragment of a branch with leaves in all cases lacking their tips	244
8 ^a . Leaf magnified, but lacking the tip.....	244

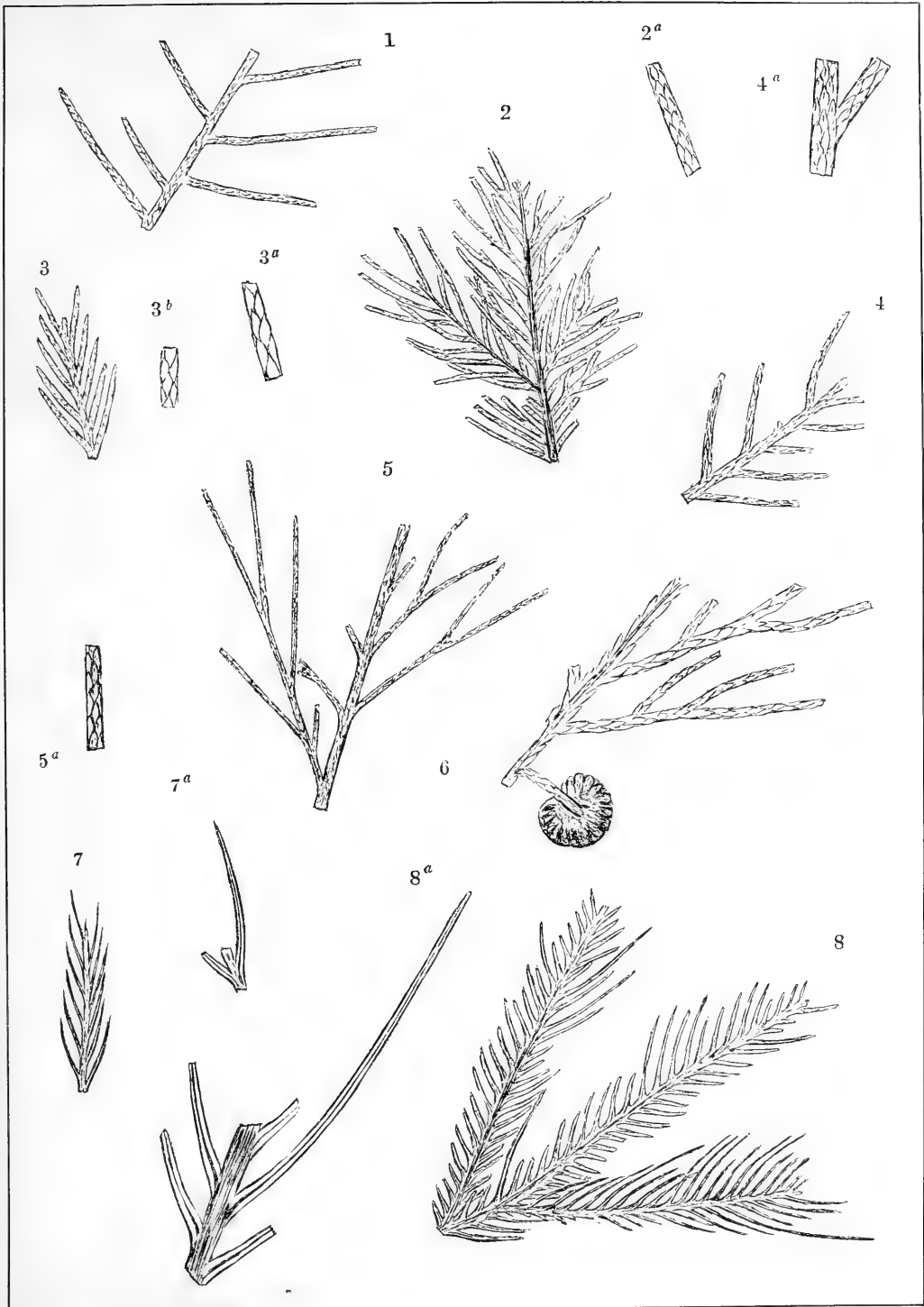



PLATE CXVIII.

PLATE CXVIII.

	Page.
FIGS. 1, 4. <i>SEQUOIA REICHENBACH</i> (Geinitz. sp.) Heer	243
1. Portion of a twig with unusually remote leaves	243
1 ^a . Leaf magnified	243
4. Portion of a widely expanded leafy branch, slightly restored	243
FIG. 2. <i>SEQUOIA AMBIGUA</i> Heer	245
2. Small fragment of a branch	245
2 ^a . Leaves magnified	245
FIG. 3. <i>SEQUOIA RIGIDA</i> Heer	246
3. Portion of a branch with leaves of the largest size	246
3 ^a . Leaves magnified	246
FIGS. 5, 6. <i>SEQUOIA SUBULATA</i> Heer	245
5. Small fragment of an older twig	245
5 ^a . Portion of a leaf magnified	245
6. Portions of several ultimate leafy twigs with leaves of maximum length	245
6 ^a . Leaves magnified	245
FIG. 7. <i>SPHENOLEPIDIUM STERNBERGIANUM</i> , var. <i>DENSIFOLIUM</i> Heer	261
7. Fragment of a small twig	261



PLATE CXIX.

PLATE CXIX.

	Page.
FIGS. 1-5. SEQUOIA REICHENBACHI (Geinitz, sp.) Heer.....	243
1. Portions of a large branch	243
2. Fragment of a branch with densely crowded leaves	243
2 ^a . Portion of 2 magnified	243
3. Fragments of a copiously branching twig carrying short leaves	243
4. Portion of an old twig showing scars of fallen leaves	243
5. Portion of an old twig, slightly magnified and showing leaf-scars, partially re- stored	243

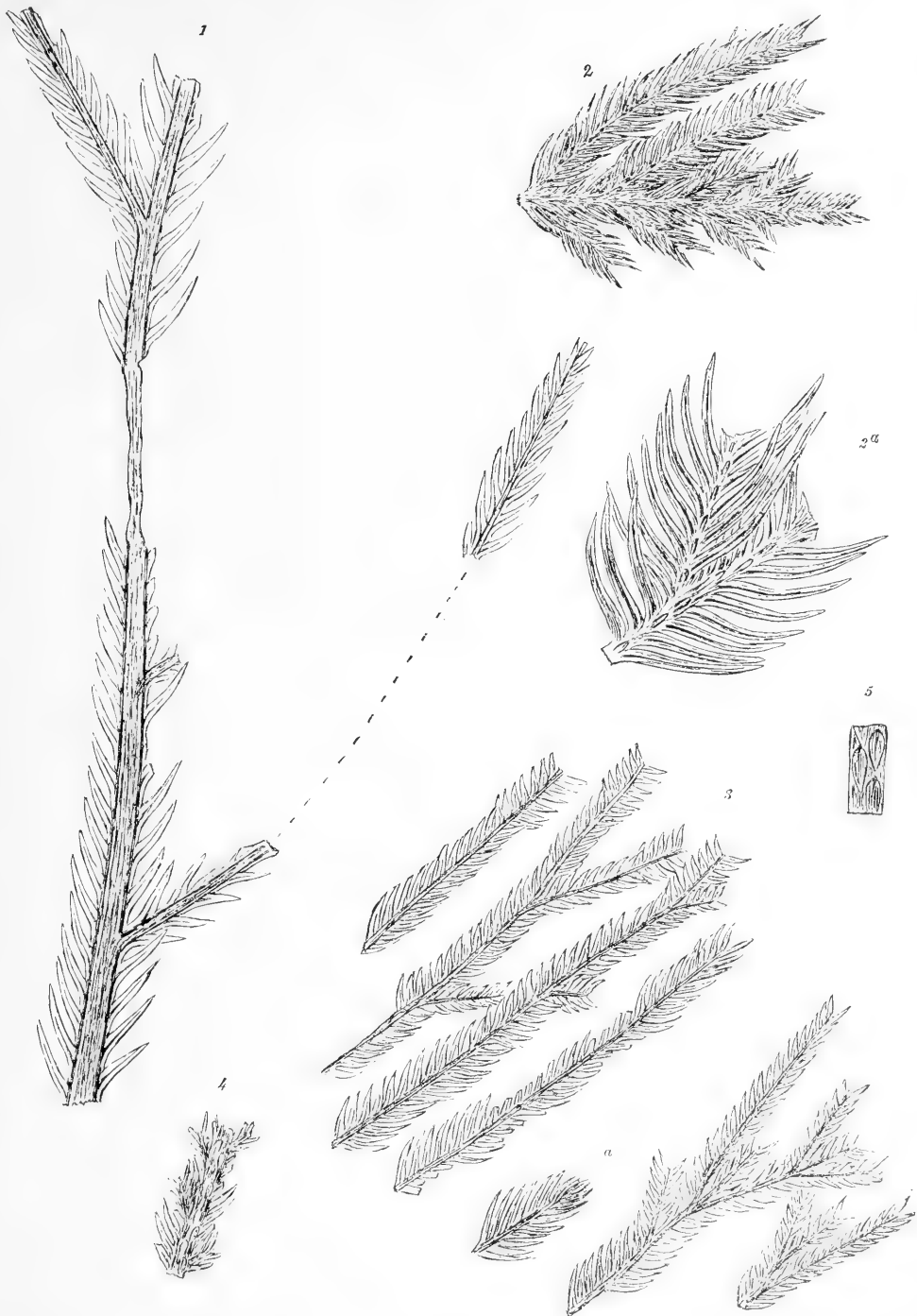

PLATE CXX.

PLATE CXX.

	Page.
FIGS. 1-6. SEQUOIA AMBIGUA Heer, sp. nov.	245
1. Portion of a branch with a cone. The upper cone seems to be placed by accident on the leafy twig carrying it.....	245
2. Fragment of a branch showing scars of fallen leaves on the upper surface of the stem	245
2 ^a . Scar magnified.....	245
3. Fragment of a partially decorticated branch, retaining a portion of only one ultimate twig	245
4. Portion of a branch with many leafy twigs	245
5. Summit of a leafy branch with unusually long leaves	245
6. Leafy twig with a cone at its apex	245
6 ^a . Outer surface of a scale of the cone magnified	245
FIGS. 7, 8. SEQUOIA REICHENBACHI (Geinitz, sp.) Heer	243
7. Fragment of an old branch with the leaves departing from the stem nearly at right angles	243
8. Fragment of an ultimate twig	243
8 ^a . Leaves of 8 magnified.....	243
FIG. 9. SEQUOIA, sp. ?	243
9. Stem of Sequoia, showing leaf-scars	243

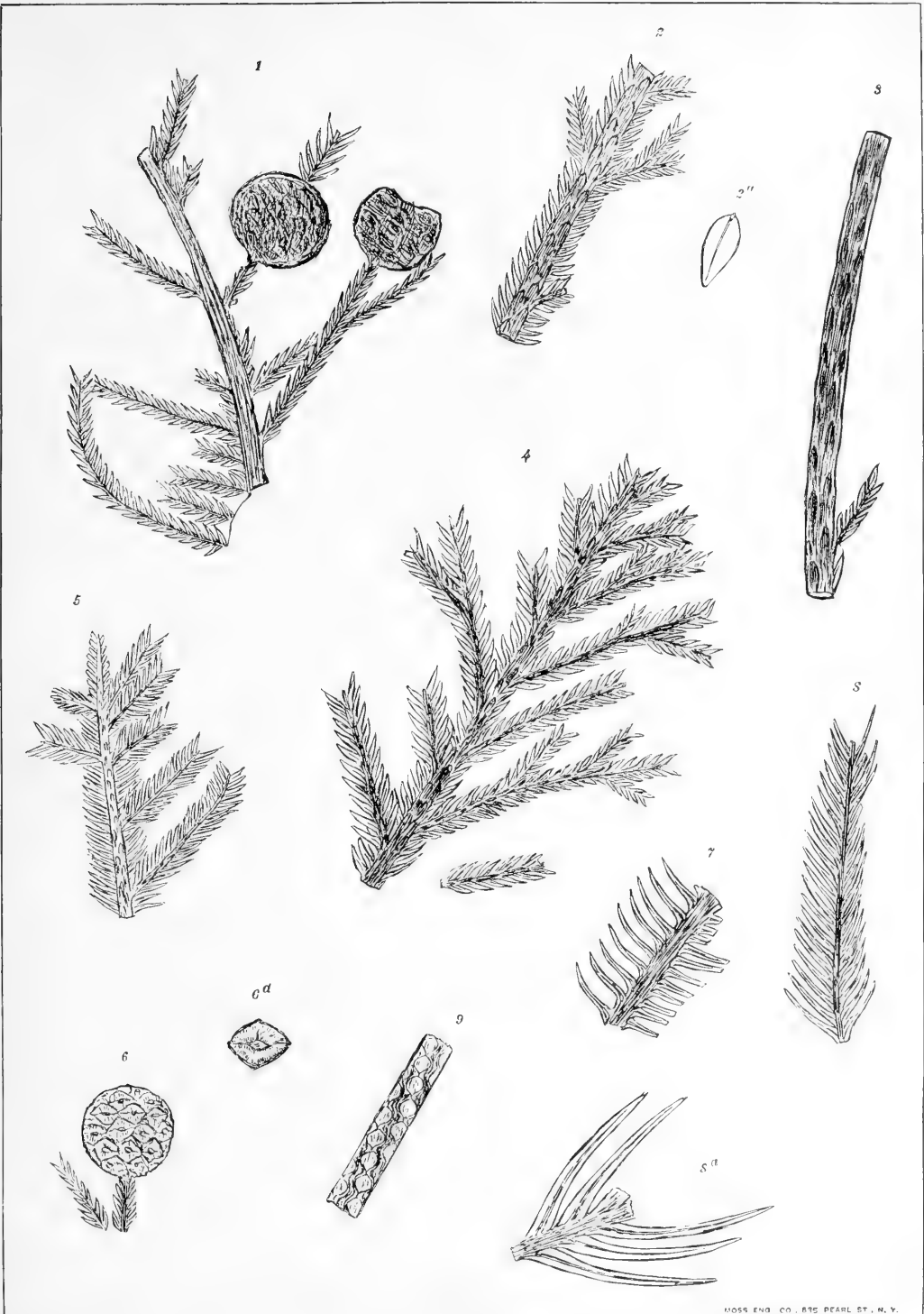

PLATE CXXI.

PLATE CXXI.

	Page.
FIG. 1. ARAUCARIA ZAMOIDES, sp. nov.	250
1. Tip of an ultimate twig.....	250
1 ^a . Leaves magnified.....	250
FIG. 2. SEQUOIA RIGIDA Heer.....	246
2. Portion of a twig with leaves of medium size.....	246
2 ^a . Leaves magnified.....	246
FIG. 3. SEQUOIA DELICATULA, sp. nov.....	247
3. Portion of a leafy branch slightly restored.....	247
3 ^a . Portion magnified.....	247
FIG. 4. SEQUOIA DENSIFOLIA, sp. nov.....	246
4. Portion of an ultimate twig.....	246
4 ^a . Leaves magnified.....	246
FIGS. 5, 7, 9. SPHENOLEPIDIUM STERNBERGIANUM, var. DENSIFOLIUM Heer.....	261
5, 7. Portions of detached ultimate twigs.....	261
5 ^a , 5 ^b . Different portions of 5 magnified.....	261
7 ^a . Leaves of 7 magnified.....	261
9. Portion of a twig with several branches.....	261
9 ^a . Leaves magnified.....	261
FIG. 6. TAXODIUM (GLYPTOSTROBUS) VIRGINICUM, sp. nov.....	252
6. Portion of a branch with several ultimate twigs.....	252
FIGS. 8, 10, 11. SPHENOLEPIDIUM STERNBERGIANUM (Dunk. sp.) Heer.....	261
8, 11. Portions of ultimate twigs.....	261
8 ^a . Leaves of 8 magnified.....	261
10. Portions of several ultimate twigs.....	261
10 ^a . Leaves magnified.....	261

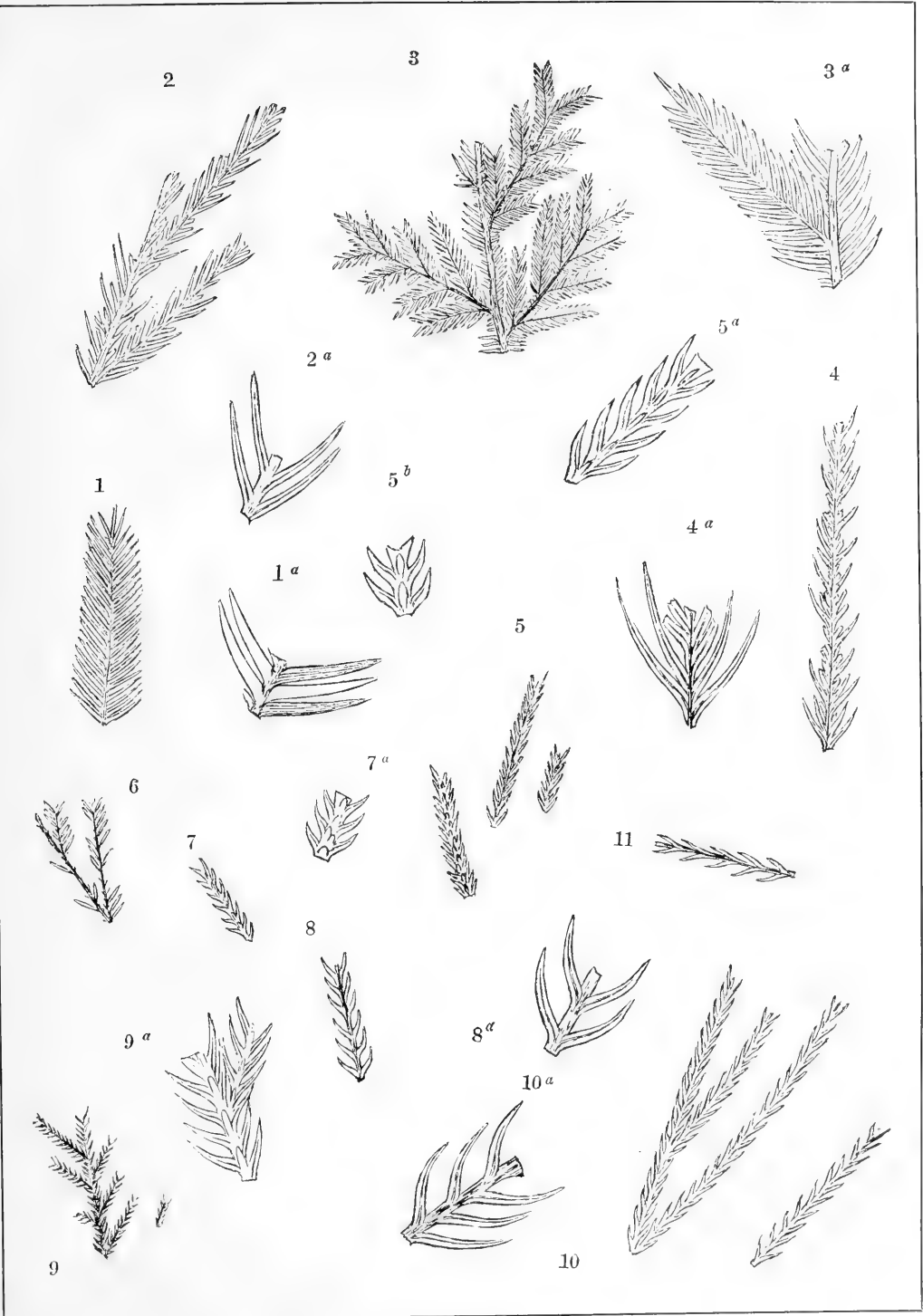

PLATE CXXII.

PLATE CXXII.

	Page.
FIG. 1. TAXODIUM (GLYPTOSTROBUS) BROOKENSE, sp. nov.	254
1. Portion of a large widely expanded branch, with twigs of maximum thickness, slightly restored.	254
1 ^a , 1 ^b . Portions of ultimate twigs magnified.	254
1 ^b . Shows the more characteristic form and attachment of the leaves.	254
FIG. 2. SEQUOIA REICHENBACHII (Geinitz, sp.) Heer	243
2. Probably a portion of an older twig of <i>Sequoia Reichenbachi</i>	243

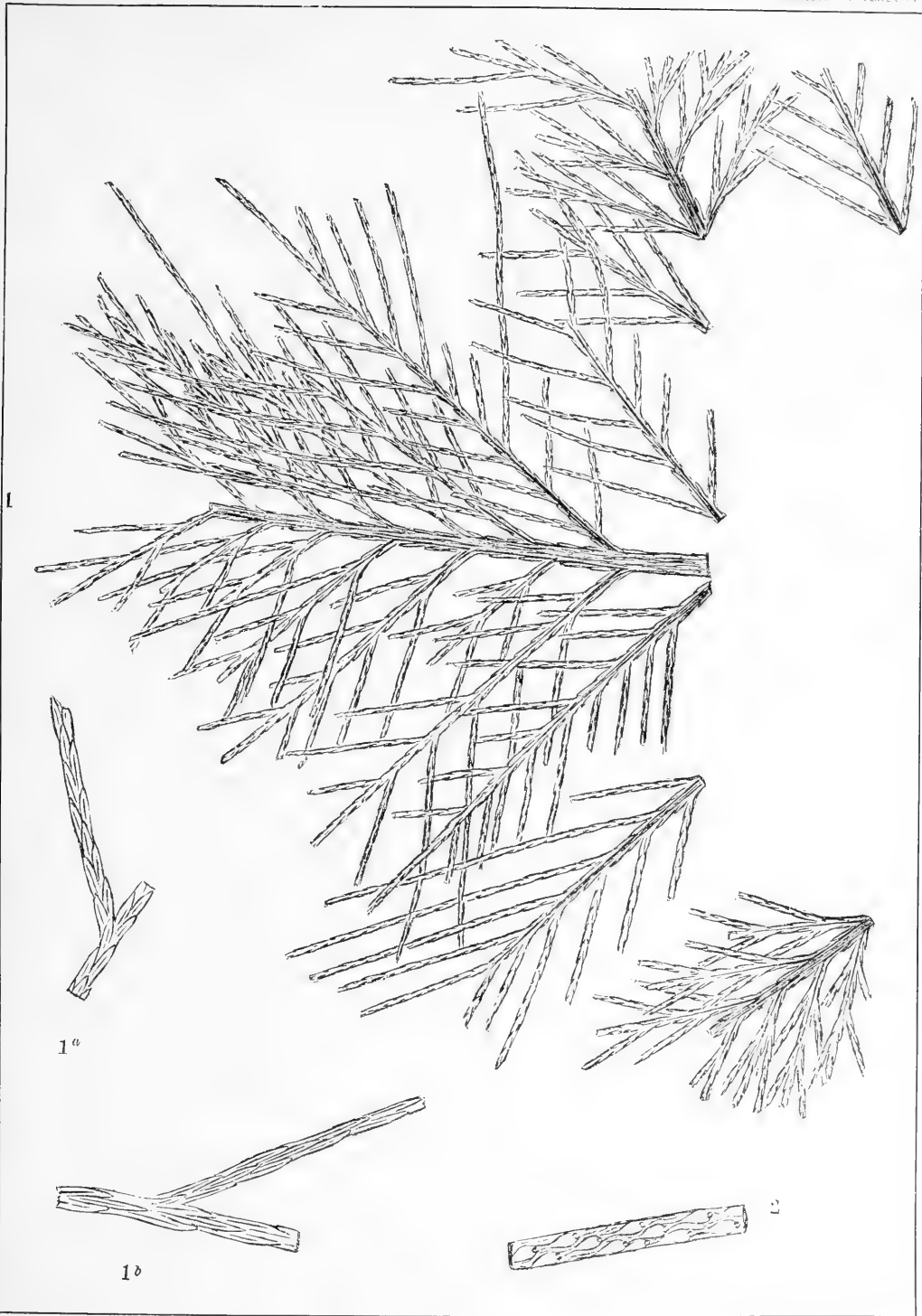

PLATE CXXIII.

PLATE CXXIII.

	Page.
FIG. 1. TAXODIUM (GLYPTOSTROBUS) EXPANSUM, sp. nov.	252
1. Fragment of a wide-spreading branch	252
1 ^a . Leaves of the ultimate twigs magnified	252
1 ^b . Leaves of the main stem magnified	252
FIGS. 2, 3. TAXODIUM (GLYPTOSTROBUS) RAMOSUM, sp. nov.	251
2. Fragment of a medium-sized branch	251
2 ^a . Portion of the same magnified, and showing at <i>b</i> the tip of one of the ultimate twigs where a male strobile has fallen off	251
3. Fragment of a copiously branching stem with many short ultimate twigs	251
3 ^a , 3 ^b . Short ultimate twigs magnified	251



1^a

1^b



1

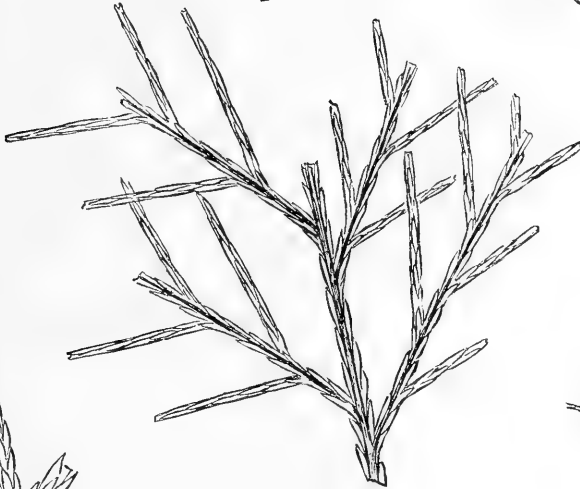

2

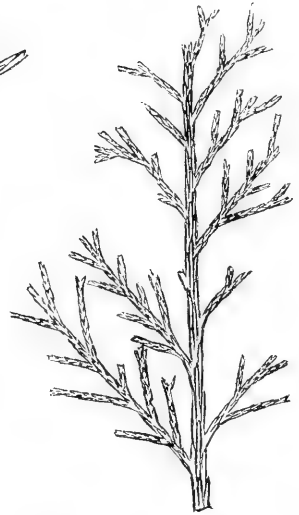

3^b



2^a

3^a

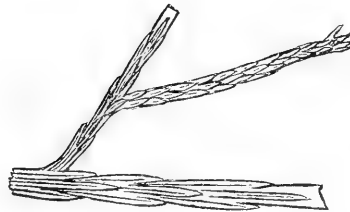
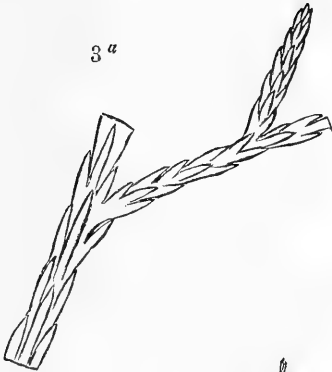

3



PLATE CXXIV.

PLATE CXXIV.

	Page.
FIG. 1. TAXODIUM (GLYPTOSTROBUS) DENTICULATUM, sp. nov.	253
1. Small fragment of a branch.....	253
1 ^a . Portion of 1 magnified.....	253
FIG. 2. TAXODIUM (GLYPTOSTROBUS) RAMOSUM, sp. nov.	251
2. Several fragments of branches showing ultimate twigs from the tips of which male strobiles have fallen.....	251
2 ^a . Ultimate twig magnified.....	251
FIGS. 3-9. TAXODIUM (GLYPTOSTROBUS) BROOKENSE, sp. nov.	254
3. Fragment of branches showing leaves unusually divergent.....	254
3 ^a . Portion of a twig magnified.....	254
4, 8. Fragments of branches with ultimate twigs of the maximum normal thickness ...	254
4 ^a . Portion of an ultimate twig magnified.....	254
5, 6, 7. Portions of ultimate twigs of unusual thickness; 7 has the leaves more than commonly divergent.....	254
7 ^a . Portion of 7 magnified.....	254
9. Fragments of a branch with thick ultimate twigs and the leaves on the main stem unusually divergent.....	254

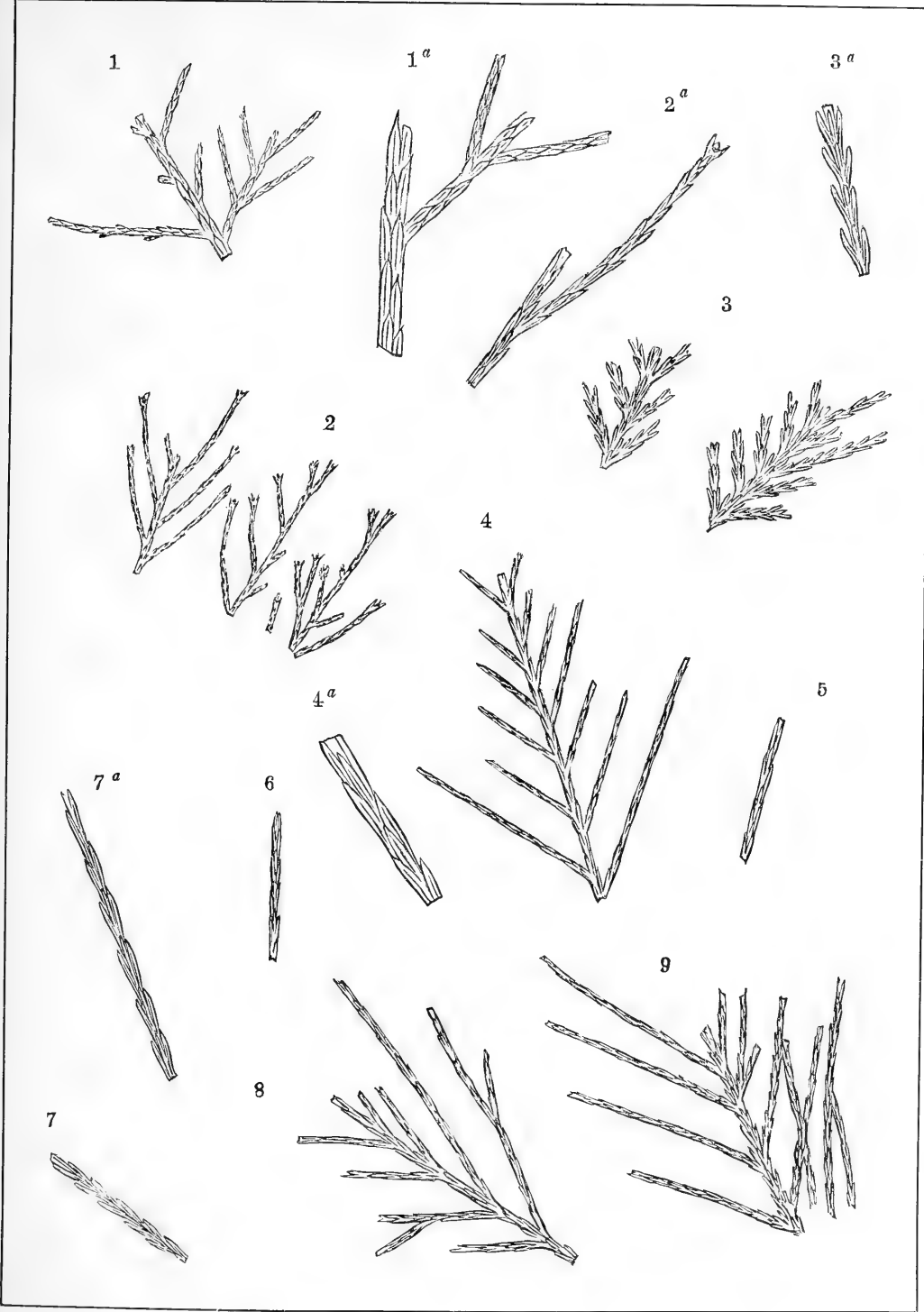

PLATE CXXV.

PLATE CXXV.

	Page.
FIGS. 1, 3. TAXODIUM (GLYPTOSTROBUS) FASTIGIATUM, sp. nov	253
1. Fragments of a very large branch	253
1 ^a . Leaves of the principal stem magnified	253
1 ^b . Leaves of the ultimate twigs magnified	253
3. Fragments of subordinate twigs	253
3 ^a . Part of 3 magnified	253
FIG. 2. SPHENOLEPIDIUM STERNBERGIANUM Heer, var. DENSIFOLIUM	261
2. Small fragment of a branch	261
2 ^a . Leaves magnified	261
FIG. 4. SPHENOLEPIDIUM VIRGINICUM, sp. nov	259
4. Fragment of a branch bearing ripe cones and male strobiles; male strobiles at α	259
4 ^a . Leaves magnified	259



PLATE CXXVI.

PLATE CXXVI.

	Page.
FIGS 1, 5, 6. SPHENOLEPIDIUM KURRIANUM Heer.....	260
1. Portion of a copiously branched twig	260
1 ^a . Portion of 1 magnified	260
5. Portions of several detached branches.....	260
5 ^a . Portion of 5 magnified.....	260
6. Portion of a copiously branched twig	260
6 ^a . Portion of 6 magnified.....	260
FIG. 2. SEQUOIA RIGIDA Heer	246
2. Fragment of a copiously branched twig.....	246
2 ^a . Leaves magnified	246
FIGS. 3, 4. SEQUOIA GRACILIS Heer.....	247
3. Portion of a small twig.....	247
3 ^a . Leaves magnified	247
4. Fragment of a copiously branching twig	247

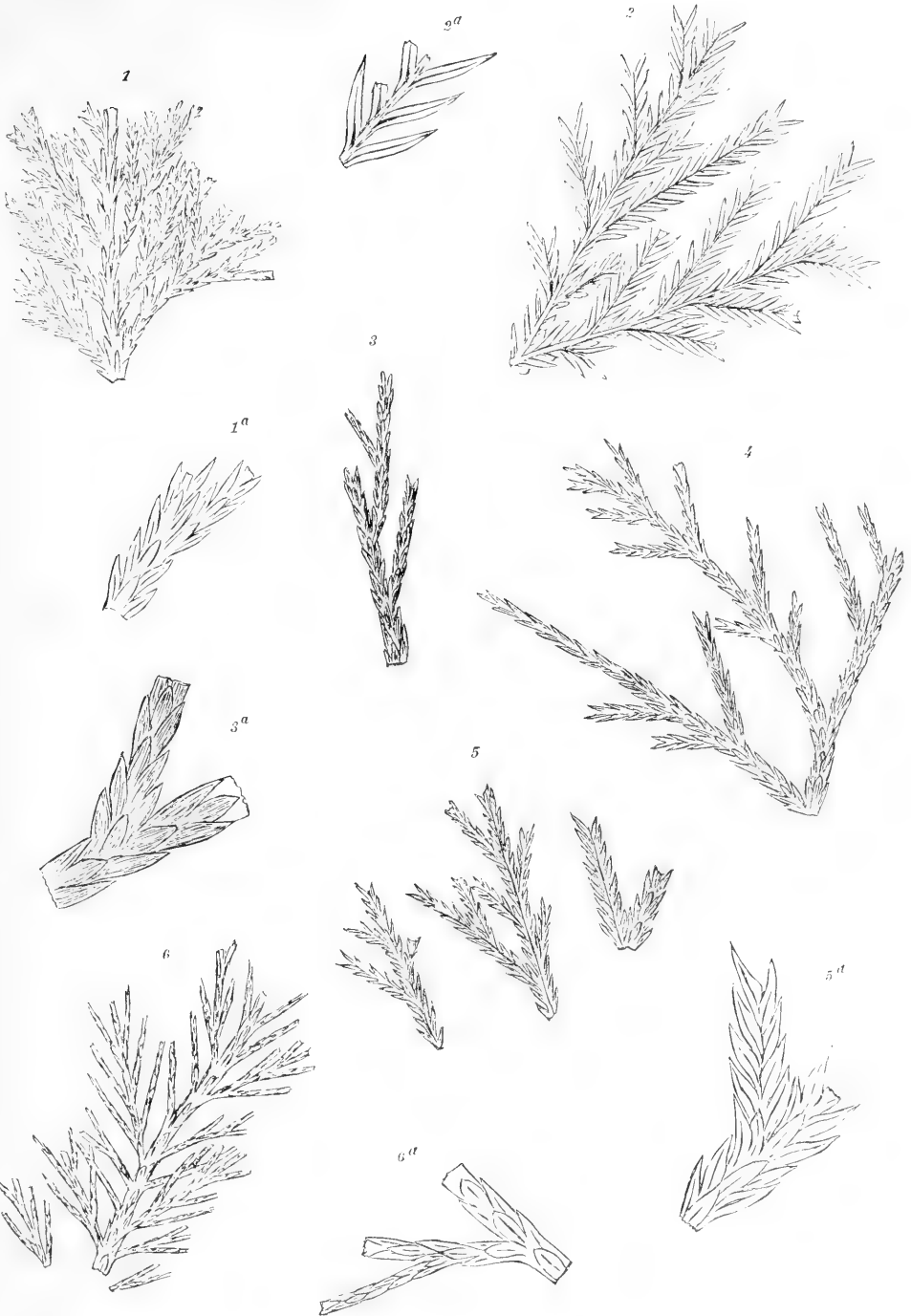

PLATE CXXVII.

PLATE CXXVII.

	Page.
FIG. 1. TAXODIUM (GLYPTOSTROBUS) RAMOSUM, sp. nov.	251
1. Fragment of a medium-sized branch	251
FIG. 2. SPHENOLEPIDIUM RECURVIFOLIUM, sp. nov.	258
2. Portions of a large branch slightly restored	258
2 ^a . Leaves of 2 magnified.	258
FIGS. 3, 4. SPHENOLEPIDIUM DENTIFOLIUM, sp. nov.	258
3. Fragment of a branch with unusually slender woody axes. Two branches over'ap near their insertions	258
4. Termination of a twig with leaf-buds	258
FIG. 5. SEQUOIA AMBIGUA Heer.	245
5. Fragment of a leafy branch	245
5 ^a . Leaves magnified	245

1



2



4



2^a



3



a

5

5^a



PLATE CXXVIII.

PLATE CXXVIII.

	Page.
FIGS. 1, 7. SPHENOLEPIDIUM KURRIANUM Heer.....	260
1. Fragment of a copiously branching twig	260
1 ^a . Portion of 1 magnified	260
7. Fragment of a branch with thick ultimate twigs	260
7 ^a . Portion of 7 magnified	260
FIGS. 2-6. SPHENOLEPIDIUM DENTIFOLIUM, sp. nov	258
2. Portions of detached twigs of the largest size	258
2 ^a . Portion of 2 magnified	258
3, 4, 6. Fragments of twigs of average size.....	258
3 ^a , 6 ^a . Portions of 3 and 6 magnified.....	258
5. Fragments of twigs with closely placed ultimate branches.....	258
5 ^a . Leaves magnified.....	258

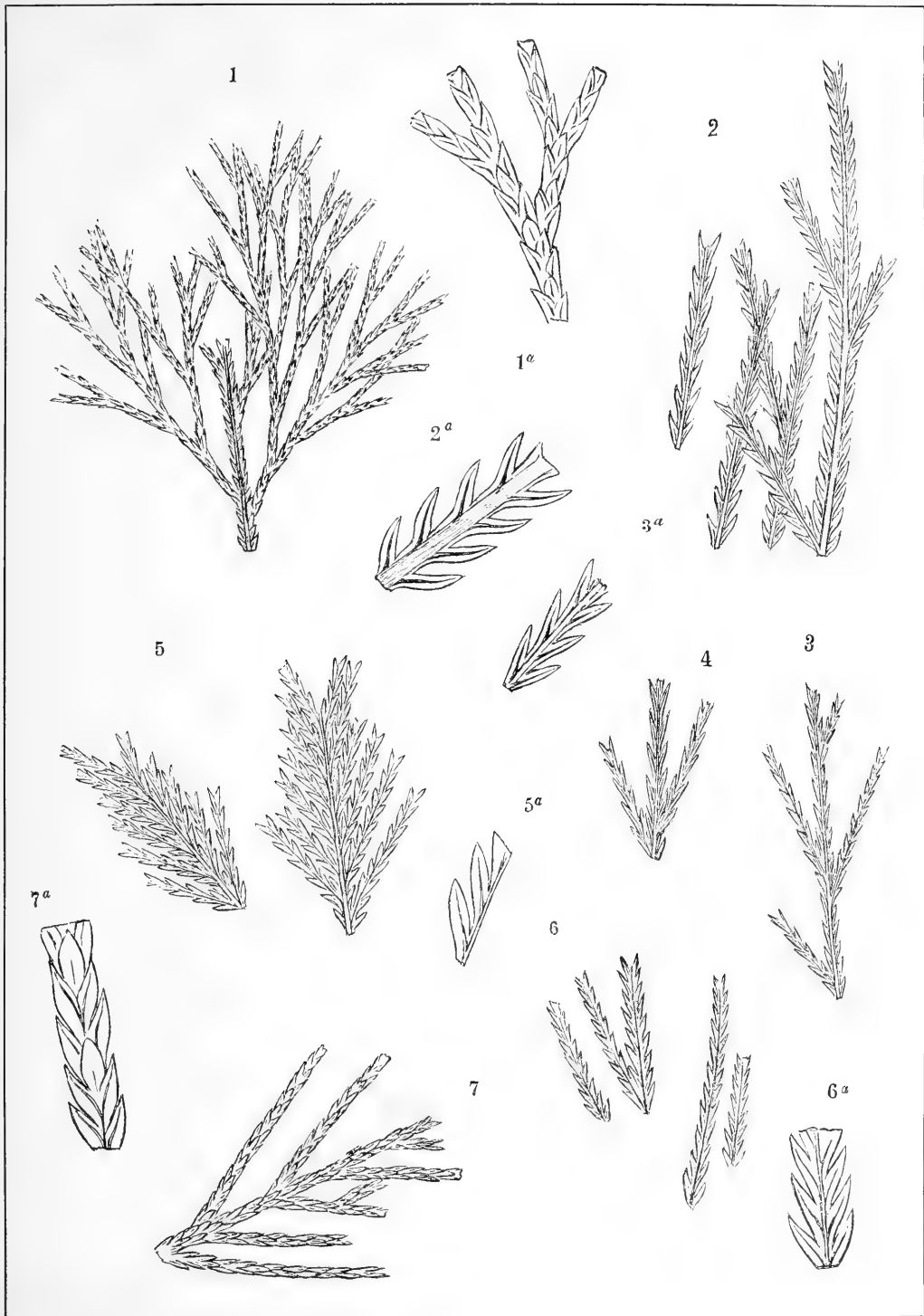

PLATE CXXIX.

PLATE CXXIX.

	Page.
FIGS. 1, 2, 4, 6, 8. SPHENOLEPIDIUM KURRIANUM Heer.....	260
1. Fragment of a branch with unusually small leaves.....	260
1 ^a . Leaves magnified.....	260
2. Portion of a twig with narrow and unusually divergent leaves; possibly a variety.....	260
4. Small fragment with dimorphous leaves.....	260
4 ^a . Leaves of the main stem magnified.....	260
6. Small portion of an ultimate twig. It has the appearance of <i>Inolepis</i> Heer..	260
8. Portions of several twigs attached to a large stem.....	260
8 ^a . Portion of the twigs magnified.....	260
FIG. 3. SPHENOLEPIDIUM STERNBERGIANUM Heer, var. DENSIFOLIUM.....	261
3. Portion of a twig with unusually broad leaves.....	261
3 ^a . Portion of 3 magnified.....	261
FIG. 5. SPHENOLEPIDIUM DENTIFOLIUM, sp. nov.....	258
5. Portion of a small twig.....	258
FIG. 7. SPHENOLEPIDIUM PARCERAMOSUM, sp. nov.....	257
7. Fragment of a very long and slender branch.....	257
7 ^a . Leaves of the main stem magnified.....	257
7 ^b . Leaves of the ultimate twigs magnified.....	257

1



2



3



3^a



1^a



5



4



4^a



6



7



7^b



8



8^a



7^a



PLATE CXXX.

PLATE CXXX.

	Page.
FIG. 1. SPHENOLEPIDIUM STERNBERGIANUM, var. DENSIFOLIUM Heer	261
1. Fragment with large lateral leaves, and showing no facial ones	261
1 ^a . Leaves magnified	261
FIGS. 2, 7. SPHENOLEPIDIUM RECURVIFOLIUM, sp. nov.	258
2. Portion of an ultimate twig	258
2 ^a . Leaves magnified	258
7. Portion of a branching twig	258
7 ^a . Leaves magnified	258
FIG. 3. SEQUOIA RIGIDA Heer	246
3. Fragments of twigs with short leaves	246
3 ^a . Leaves magnified	246
FIGS. 4-6, 10. SPHENOLEPIDIUM DENTIFOLIUM, sp. nov.	258
4. Fragment of a large branch with small leaves	258
4 ^a . Leaves magnified. This form and 5 look like some forms of <i>Sphenopteris Mantelli</i>	258
5. Fragment of a large ultimate twig	258
5 ^a . Leaves magnified	258
6. Tip of a twig with two lateral leaf-buds and a terminal undeveloped twig	258
10. Portion of a small twig	258
10 ^a . Leaves magnified	258
FIG. 8. SPHENOLEPIDIUM PARCERAMOSUM, sp. nov.	257
8. Portion of a twig	257
8 ^a . Leaves of the ultimate twigs magnified	257
FIG. 9. SPHENOLEPIDIUM STERNBERGIANUM Heer	261
9. Portion of a twig with normal leaves	261
9 ^a . Leaves magnified	261
FIG. 11. SPHENOLEPIDIUM KURRIANUM Heer	260
11. Small fragment of a branch; the detached leaf-bud near it is probably that of <i>Sphenolepidium dentifolium</i>	260
11 ^a . Leaves magnified	260

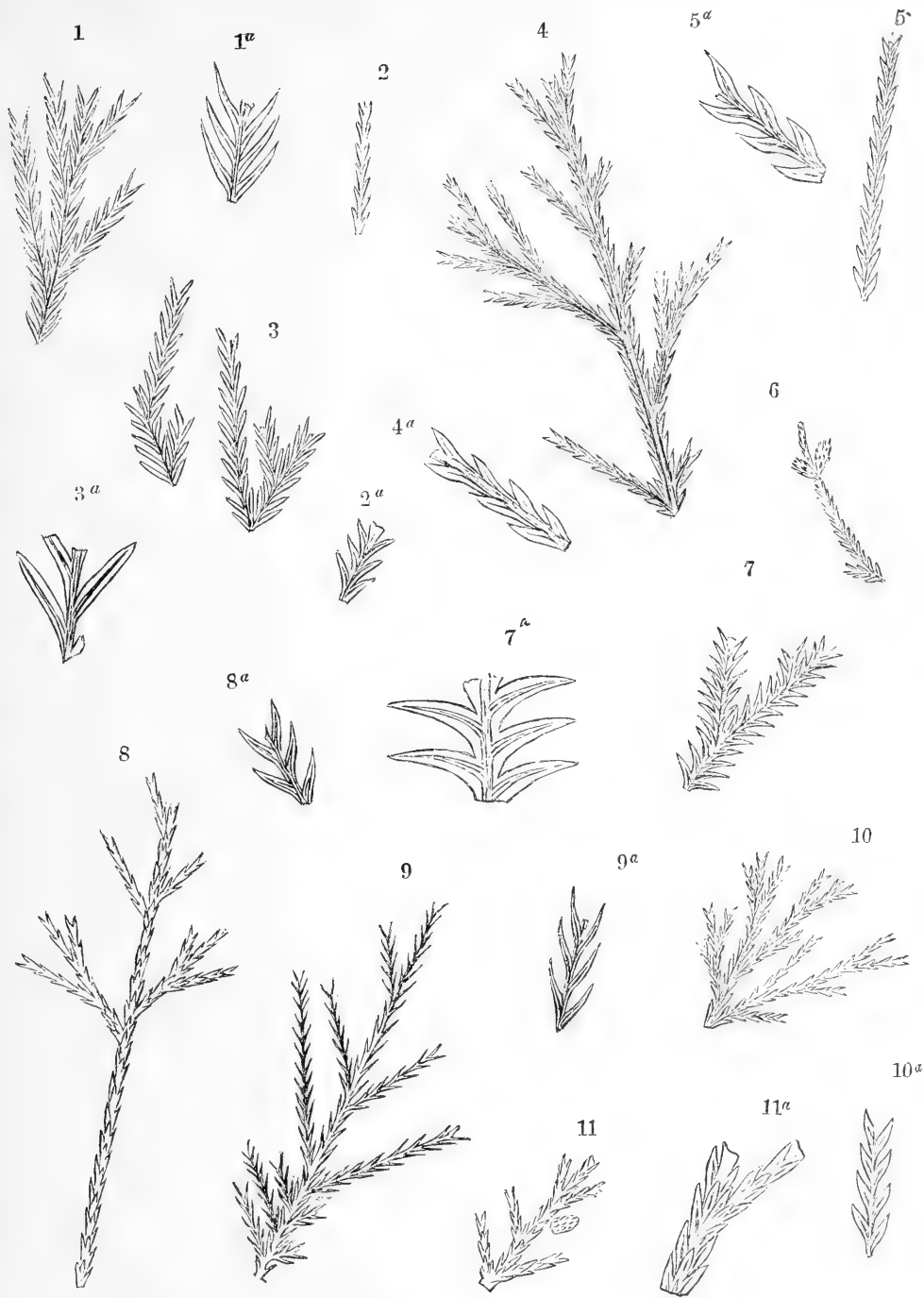

PLATE CXXXI.

PLATE CXXXI.

	Page.
FIGS. 1, 3. SPHENOLEPIDIUM STERNBERGIANUM, var. DENSIFOLIUM Heer.....	261
1. Fragment of a branch with undeveloped twigs and leaf-buds	261
1 ^a -1 ^c . Portions of 1 magnified.....	261
3. Fragments of very slender twigs.....	261
3 ^a . Leaves magnified	261
FIG. 2. SPHENOLEPIDIUM PARCERAMOSUM, sp. nov.....	257
2. Fragment showing long slender branches	257
FIG. 4. SPHENOLEPIDIUM KURRIANUM Heer	260
4. Fragment showing stout twigs	260
FIG. 5. TAXODIUM (GLYPTOSTROBUS) BROOKENSE, sp. nov.....	254
5. Fragment of a branch showing unusually divergent lateral leaves	254
5 ^a . Leaves magnified.....	254
FIGS. 6, 7. SPHENOLEPIDIUM PACHYPHYLLUM, sp. nov.....	259
6. Portion of a twig showing leaves of the largest size	259
7. Portion of a twig with lateral branches	259
7 ^a . Leaves of 7 magnified	259

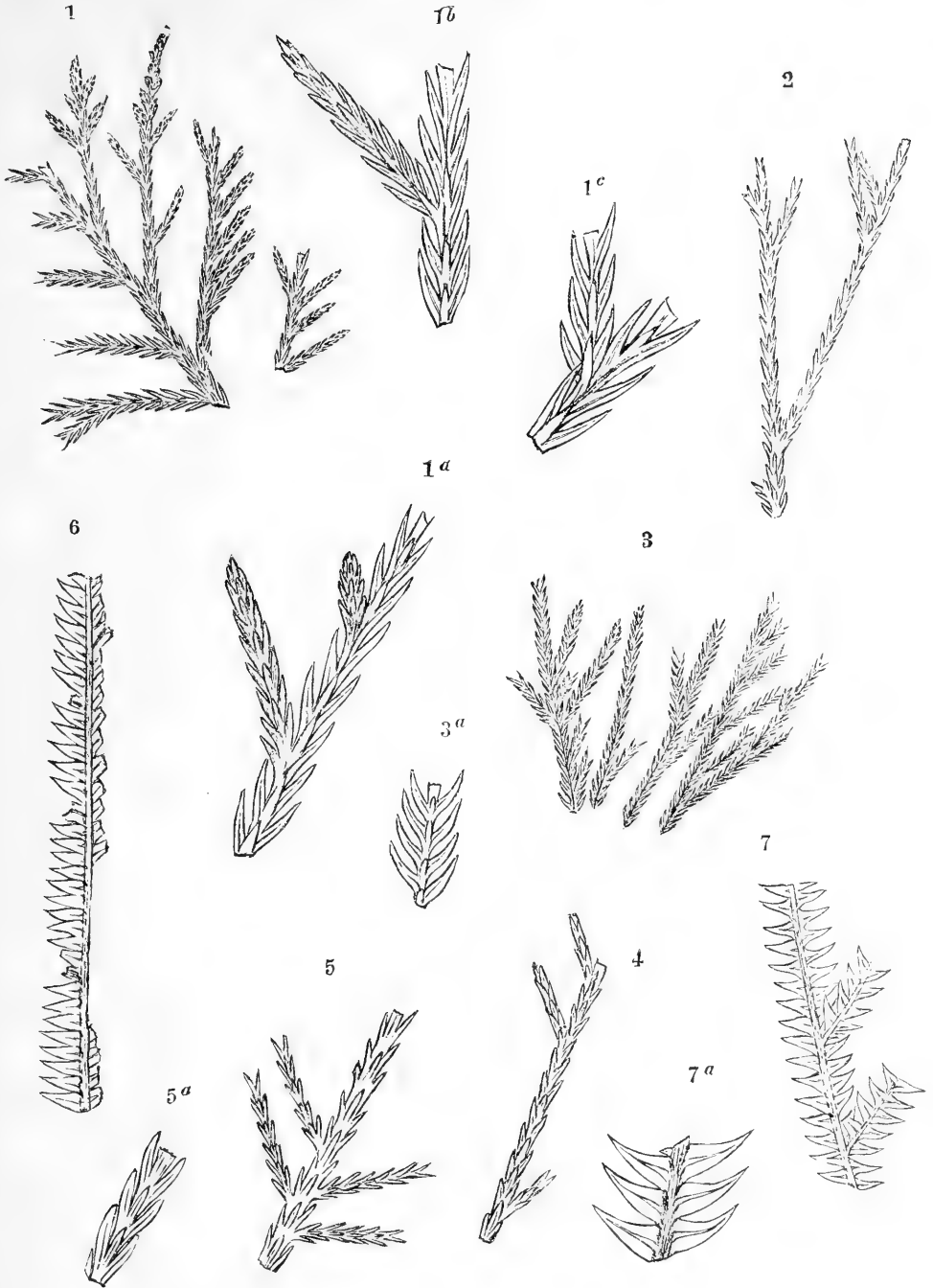

PLATE CXXXII.

P L A T E C X X X I I .

	Page.
FIG. 1. TAXODIUM (GLYPTOSTROBUS) RAMOSUM, sp. nov	251
1. Portion of a fastigiately branched twig	251
1 ^a . Portion of 1 magnified	251
FIGS. 2, 5, 6. SEQUOIA, sp. ?	248
2. Portion of a cone seen erect	248
2 ^a , 2 ^b . Scales of 2 magnified	248
5, 6. Portions of cross-sections of cones	248
FIG. 3. SEQUOIA AMBIGUA Heer	245
3. Fragment of a small twig	245
3 ^a . Portion of 3 magnified	245
FIG. 4. SPHENOLEPIDIUM STERNBERGIANUM Heer, var. DENSIFOLIUM	261
4. Termination of a leafy twig	261
4 ^a . Portion of 4 magnified	261
FIG. 7. ABIETITES MACROCARPUS, sp. nov	262
7. Fragment of a very long cone	262
FIGS. 8, 9. ABIETITES ELLIPTICUS, sp. nov	263
8. Portion of a cone showing the basal parts of the scales retained	263
9. Portion of a cone exposing the axis	263
FIG. 10. SEQUOIA, sp. ?	248
10. Portion of a cone seen compressed in the direction of its axis	248



PLATE CXXXIII.

PLATE CXXXIII.

	Page.
FIG. 1. ABHETITES ANGUSTICARPUS, sp. nov.	263
1. Portion of a cone showing in front the axis with scars of scales.	263
FIGS. 2-4. ABHETITES ELLIPTICUS, sp. nov.	263
2. Portion of a cone showing the bases of the scales retained.	263
3. Number of scales in natural position showing the parts by which the scales were attached.	263
4. Nearly perfect cone showing the basal parts of the scales.	263
FIGS. 5-7. WILLIAMSONIA VIRGINIENSIS, sp. nov.	273
5. The summit of the peduncle and portions of bracts or leaves void of hair-like appendages.	273
6, 7. The summits of the peduncle and bracts with hair-like appendages.	273
6 ^a . Portion magnified.	273
FIGS. 8-12. ARAUCARITES AQUIENSIS, sp. nov.	264
8-12. Scales of varying character, natural size, found always detached.	264

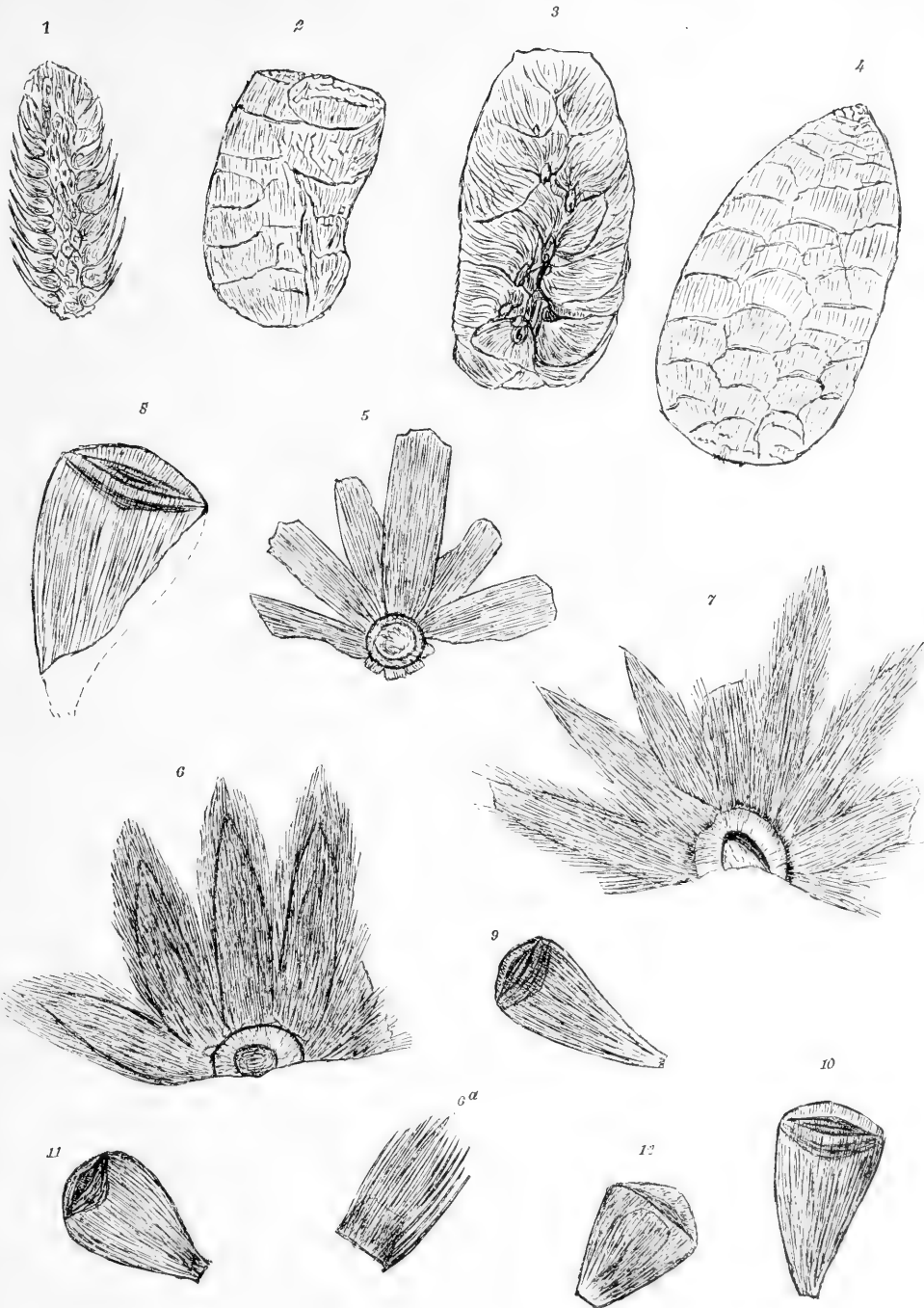

PLATE CXXXIV.

PLATE CXXXIV.

FIG.		Page.
	1. <i>CARPOLITHUS FASCICULATUS</i> , sp. nov.	265
	1. Group of nut-like seed	265
FIGS.	2-4, 6, 8. <i>CARPOLITHUS TERNATUS</i> , sp. nov.	265
	2-4, 6, 8. Groups of nut-like seed, associated mostly in clusters of threes	265
FIG.	5. <i>CARPOLITHUS AGGLOMERATUS</i> , sp. nov.	267
	5. Clusters of seed	267
FIG.	7. <i>ARAUCARITES VIRGINICUS</i> , sp. nov.	263
	7. Nearly perfect cone, with the scales retained, slightly restored	263
FIG.	9. <i>CARPOLITHUS CONJUGATUS</i> , sp. nov.	267
	9. Group of seed arranged in a radiate manner	267
FIG.	10. <i>CARPOLITHUS GEMINATUS</i> , sp. nov.	267
	10. Pair of nut-like seed	267
FIGS.	11-14. <i>CARPOLITHUS VIRGINIENSIS</i> , sp. nov.	266
	11, 13, 14. Groups of elliptical nut-like seed	266
	11 ^a , 14 ^a . Magnified seed of 11 and 14, respectively	266
	12. Nut-like seed, somewhat different from those of 11, 13, and 14	266



PLATE CXXXV.

PLATE CXXXV.

	Page.
FIGS. 1, 5. CARPOLITHUS VIRGINIENSIS, sp. nov.	266
1. A number of seeds attached.	266
5. A detached seed.	266
FIGS. 2, 4. CARPOLITHUS BROOKENSIS, sp. nov.	268
2, 4. Detached seed with long beaks.	268
2 ^a . A seed magnified.	268
FIG. 3. CARPOLITHUS LATUS, sp. nov.	269
3. Detached seed.	269
FIG. 6. LEPTOSTROBUS ? (α) sp. ? sp. nov. ?	231
6. Seed with a winged margin.	231
FIG. 7. Ament of conifer (c), sp. ?	226
7. What seems to be the male strobile of some conifer.	226
7 ^a . Portion magnified.	226
7 ^b . Single scale flattened and magnified.	226
FIG. 8. BRACHYPHYLLUM, sp. ?	223
8. What seems to be a cone of Brachyphyllum.	223
FIG. 9. BRACHYPHYLLUM, sp. ?	224
9. Cone of what seems to be a Brachyphyllum distinct from that depicted in 8.	224
FIG. 10. ATHROTAXOPSIS GRANDIS, sp. nov.	240
10. Cone.	240
FIGS. 11, 21. CYCADEOSPERMUM SPATULATUM, sp. nov.	271
11, 21. Detached seed, that appear to be those of cycads.	271
FIG. 12. CYCADEOSPERMUM ACUTUM, sp. nov.	270
12. Apparently a seed of a cycadaceous plant.	270
FIG. 13. CYCADEOSPERMUM OBOVATUM, sp. nov.	270
13. Probably a cycadaceous seed.	270
FIG. 14. Capsules, sp. ?	270
14. Twinned capsules of undetermined species.	270
FIGS. 15, 18, 22. ATHROTAXOPSIS EXPANSA, sp. nov.	241
15, 18, 22. Cones of varying size.	241
15 ^a . Magnified form of 15.	241
15 ^b . Scale of 15 magnified.	241
FIG. 16. Ament of Angiosperm, sp. ?	272
16. What seems to be a portion of an Angiosperm ament.	272
16 ^a . Portion of 16 magnified.	272
FIG. 17. CARPOLITHUS CURVATUS, sp. nov.	269
17. What seems to be a nut-like seed.	269
FIG. 19. CYCADEOSPERMUM ELLIPTICUM, sp. nov.	271
19. Seed apparently of a cycadaceous plant.	271
FIG. 20. CYCADEOSPERMUM ANGUSTUM, sp. nov.	271
20. What seems to be the seed of a cycadaceous plant.	271



PLATE CXXXVI.

PLATE CXXXVI.

	Page.
FIG. 1. MACROSPORES, ? sp. ?	274
1. What seem to be Macrospores.....	274
1 ^a . Magnified form from 1.....	274
FIG. 2. Aments of conifers (a), sp. ?	225
2. Group of detached aments	225
2 ^a . An ament magnified	225
FIG. 3. Aments of conifers (b), sp. ?	225
3. Gives aments distinct from aments (a).....	225
FIG. 4. Aments of conifers (c), sp. ?	226
4. Gives aments distinct from aments (a) and (b).....	226
4 ^a . Ament magnified	226
FIG. 5. Aments of conifers (d), sp. ?	226
5. Aments different from those designated as aments (a), (b), (c).....	226
5 ^a . Ament magnified	226
FIG. 6. CARPOLITHUS BROOKENSIS, sp. nov.	268
6. A detached seed of unusual form	268
FIG. 7. Pollen sacs ?, sp. ?	272
7. What seemed to be pollen sacs	272
7 ^a . Magnified form of 7.....	272
FIG. 8. Aments of conifers (f), sp. ?	227
8. What seem to be aments of conifers	227
8 ^a . One of 8 magnified	227
FIG. 9. CARPOLITHUS SESSILIS, sp. nov.	269
9. A nut-like seed attached.....	269
FIG. 10. LEPTOSTROBUS ? (b), sp. ?	231
10. Winged seed probably of Leptostrobus	231
10 ^a . Magnified form of 10	231
FIG. 11. LEPTOSTROBUS ? (c), sp. ?	232
11. Large winged seed	232
FIG. 12. CYCAEOSPERMUM ROTUNDATUM, sp. nov.	271
12. Detached seed.....	271
FIG. 13. Undetermined plant (a).....	271
FIG. 14. Undetermined plant (b).....	271
FIG. 15. CARPOLITHUS MUCRONATUS, sp. nov.	270
15. An attached seed	270

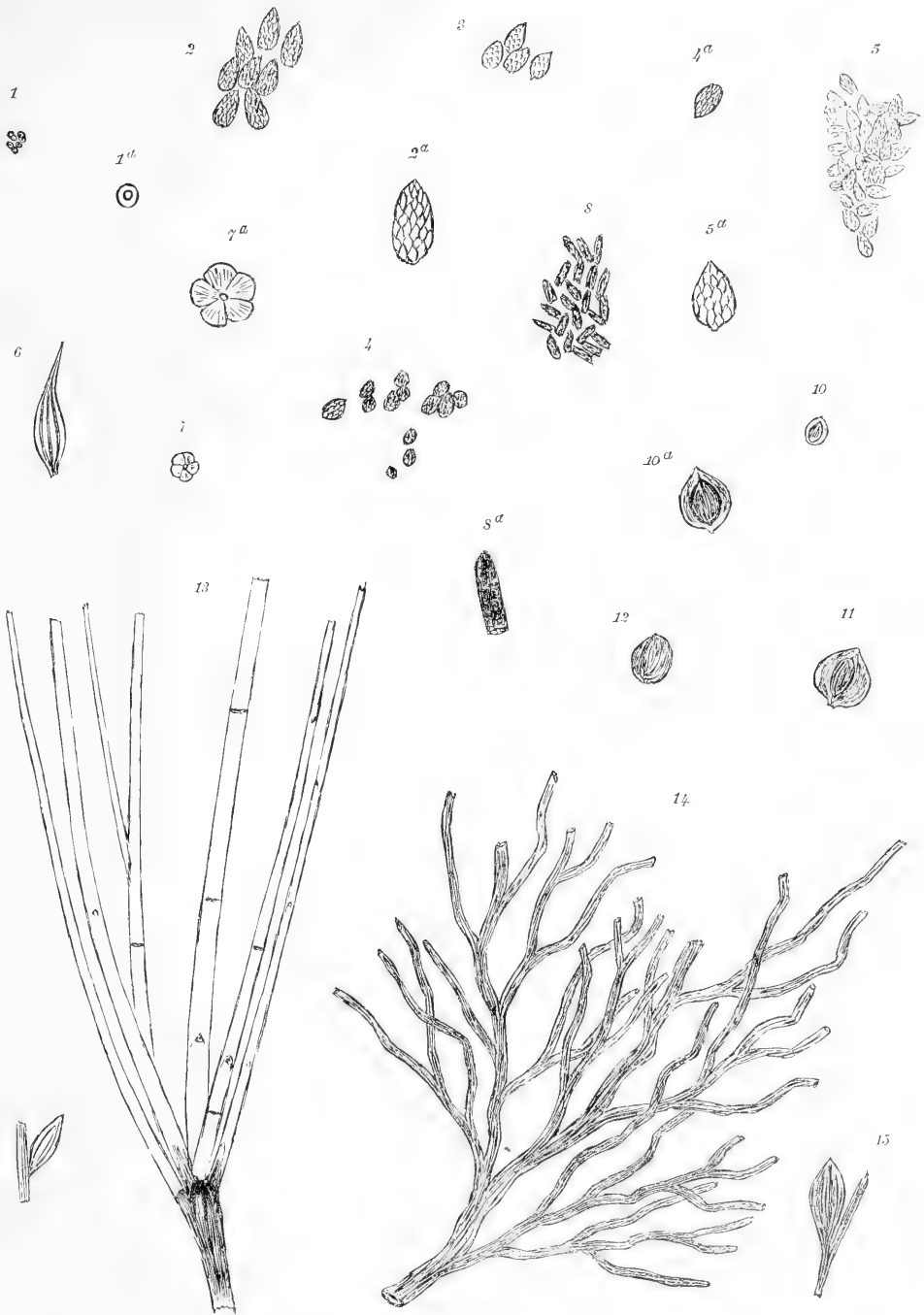

PLATE CXXXVII.

PLATE CXXXVII.

	Page.
FIG. 1. Undetermined plant (<i>c</i>).....	275
2, 3. Undetermined plant (<i>d</i>).....	275
4. Undetermined plant (<i>e</i>).....	275
5. Undetermined plant (<i>f</i>).....	275
FIG. 6. ACACLEPHYLLUM LONGIFOLIUM, sp. nov	279
6. Base of a large leaf.....	279

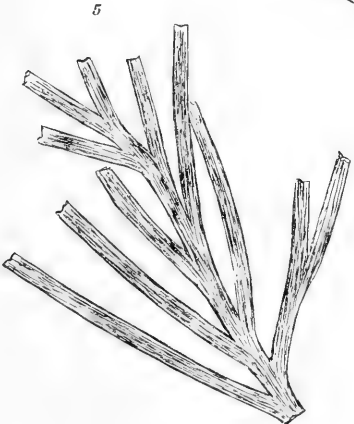
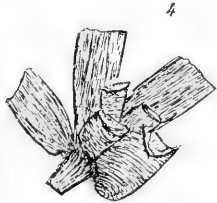
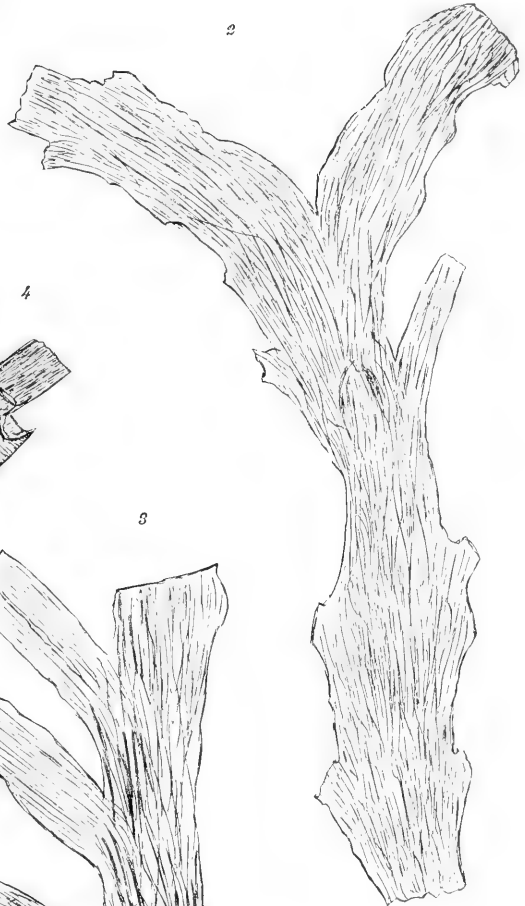

PLATE CXXXVIII.

PLATE CXXXVIII.

	Page.
FIGS. 1-3. ACACLEPHYLLUM LONGIFOLIUM, sp. nov.	279
1. Portion of a stem and two leaves.	279
2. Upper part of a large leaf.	279
3. Basal portion of a large leaf.	279
FIGS. 4, 6-9. ACACLEPHYLLUM SPATULATUM, sp. nov.	280
4. Leaf of medium size.	280
4 ^a . Leaf magnified.	280
6. Lower part of a large leaf.	280
7. Small leaf acute at tip.	280
8. Small leaf obtuse at tip.	280
9. Stem with leaves attached.	280
FIG. 5. ACACLEPHYLLUM MICROPHYLLUM, sp. nov.	280
5. Portion of a stem and a branch with attached leaves.	280
FIGS. 10-12. CTENIS IMBRICATA, sp. nov.	177
10. Summit of a leaf.	177
11. Upper portion of a leaf with portions of leaflets.	177
12. Middle portion of a leaf with basal parts of leaflets.	177
FIG. 13. SAGENOPTERIS VIRGINIENSIS, sp. nov.	150
13. Upper part of a leaf.	150
FIG. 14. CONOSPERMITES ELLIPTICUS, sp. nov.	279
14. Portion of a leaf.	279
14 ^a . Restored form of 14.	279

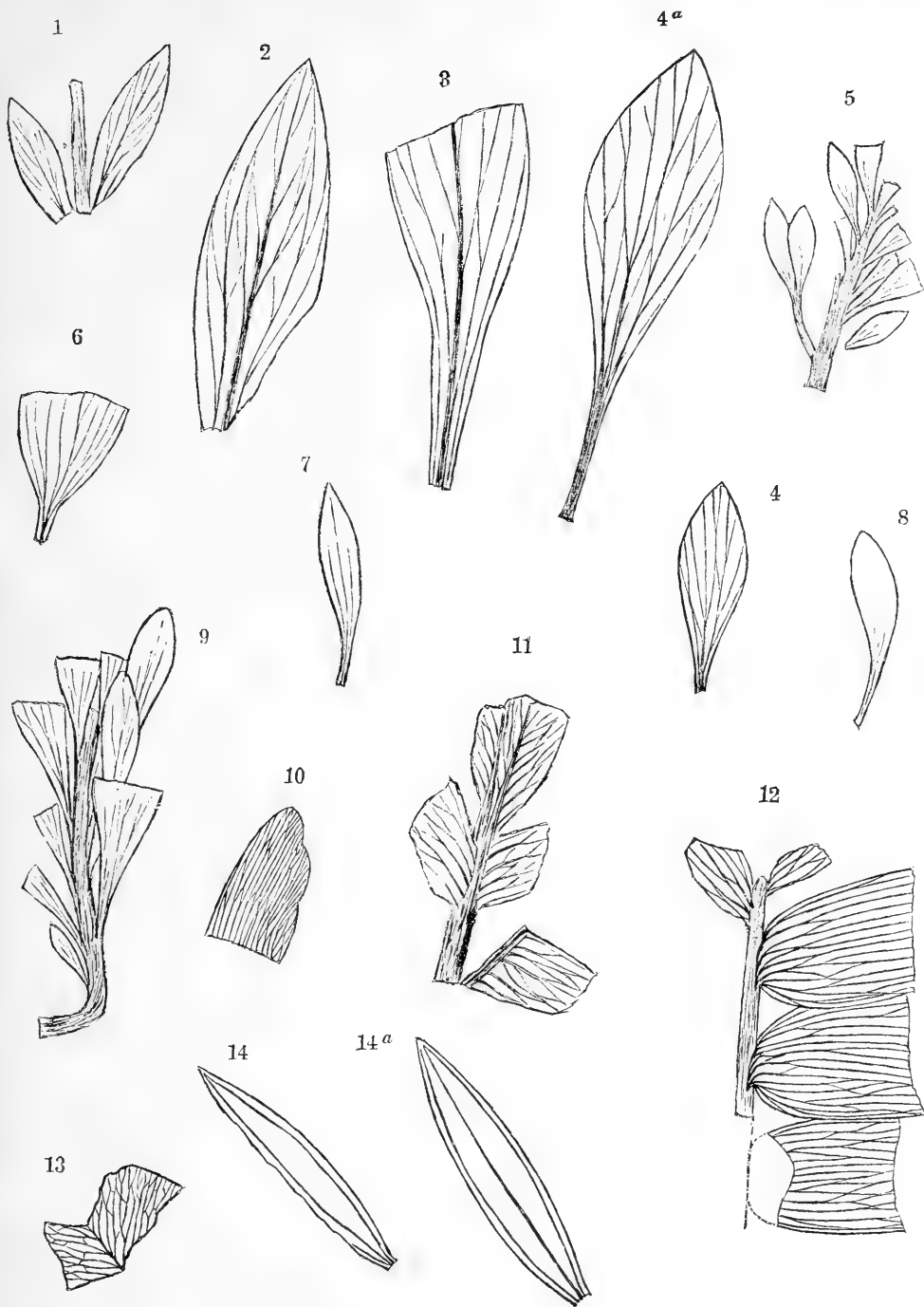

PLATE CXXXIX.

PLATE CXXXIX.

	Page.
FIG. 1. SAGENOPTERIS VIRGINIENSIS, sp. nov.	150
1. Portion of the base of a leaf	150
FIG. 2. PROTEEPHYLLUM, sp. ? sp. nov.	281
2. Tip of a leaf	281
FIG. 3. PROTEEPHYLLUM RENIFORME, sp. nov.	282
3. An entire leaf	282
3a. Leaf 3 enlarged three diameters	282
FIG. 4. PROTEEPHYLLUM ORBICULARE, sp. nov.	283
4. Greater part of a leaf,	283
4a. Portion of 4 enlarged three diameters	283
4b. Small portion of 4 more enlarged than 4a, to show ultimate reticulation	283
FIG. 5. PROTEEPHYLLUM OBLONGIFOLIUM, sp. nov.	284
5. Basal portion of a leaf	284
5a. Part of 5 enlarged three diameters	284
FIG. 6. ROGERSIA LONGIFOLIA, sp. nov.	287
6. Basal portion of a slender leaf	287
FIG. 7. SASSAFRAS PARVIFOLIUM, sp. nov.	289
7. Upper part of what seems to be a very small sassafras leaf	289

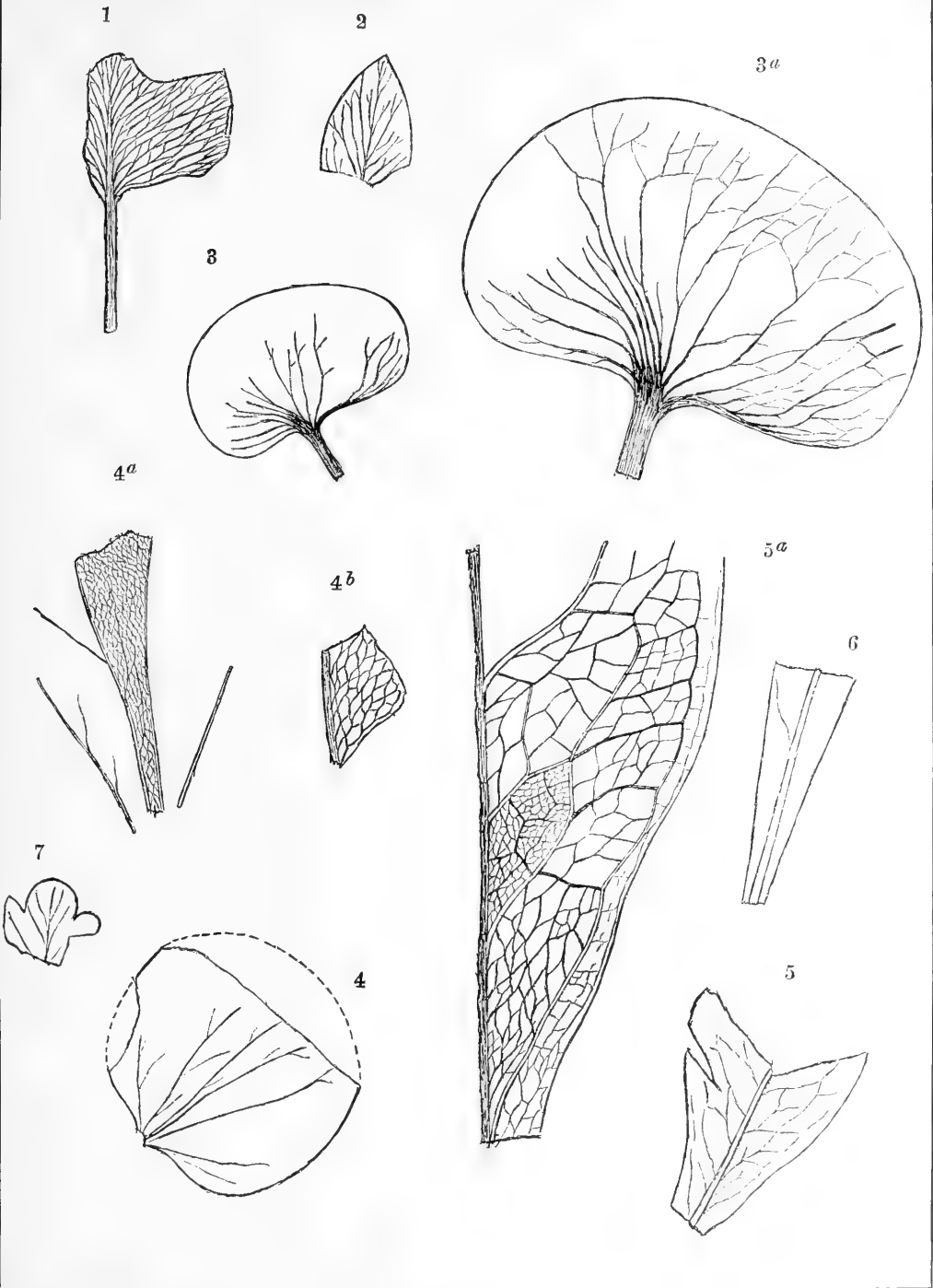
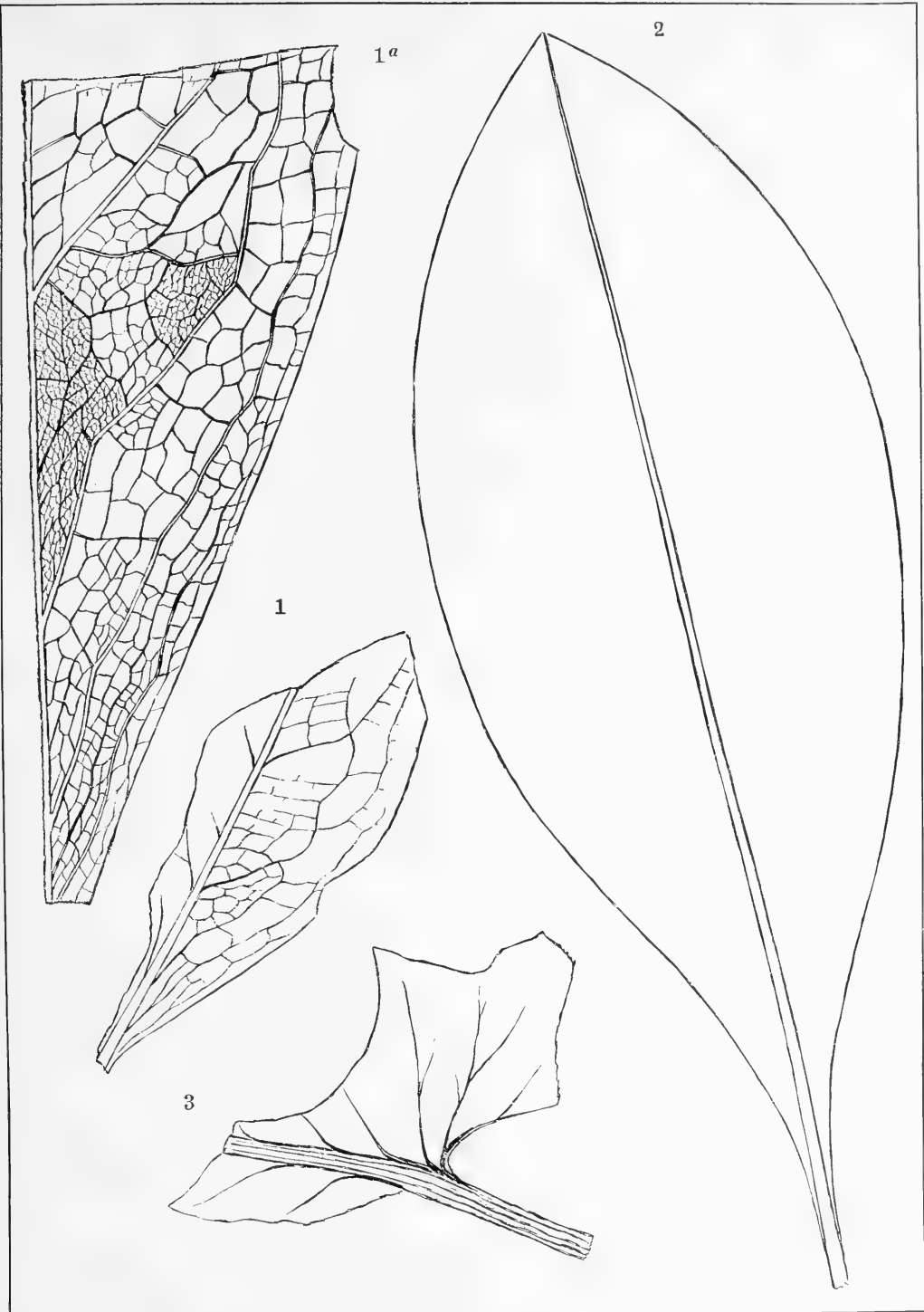

PLATE CXL.

PLATE CXL.

	Page.
FIGS. 1, 2. <i>PROTEEPHYLLUM OBLONGIFOLIUM</i> , sp. nov.	284
1. Basal portion of a leaf	284
1 ^a . Portion of 1 magnified three diameters	284
2. Restoration of the leaf, as made out by taking fragments belonging to different parts of it.	284
FIG. 3. <i>FICOPHYLLUM TENUINERVE</i> , sp. nov.	292
3. Fragment of an unusually large leaf.	292



1^a

2

1

3

PLATE CXLI.

PLATE CXLI.

	Page.
FIG. 1. <i>PROTEPHYLLUM OVATUM</i> , sp. nov.	285
1. Portion of a leaf	285
1*. Part of 1 magnified three diameters.....	285
FIG. 2. <i>FIGOPHYLLUM TENUINERVE</i> , sp. nov.	292
2. Upper part of a leaf.....	292
2*. Portion of 2 magnified three diameters.....	292

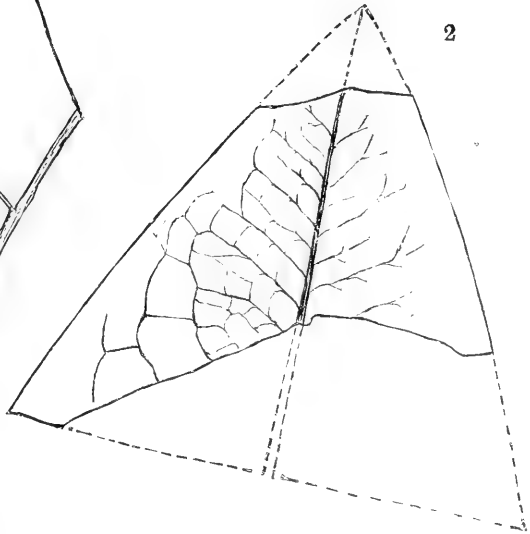
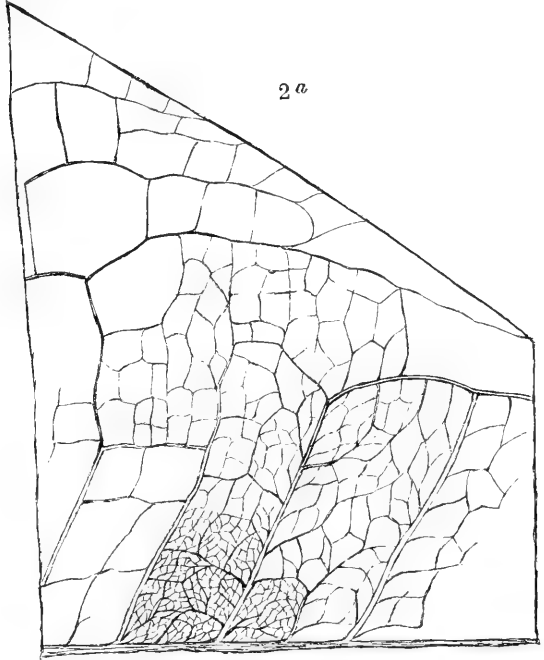
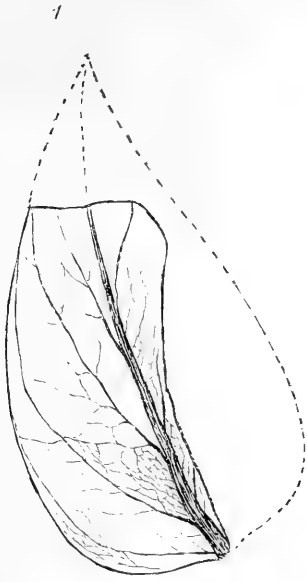

PLATE CXLII.

PLATE CXLII.

	Page.
FIGS. 1, 2. <i>PROTEOPHYLLUM ELLIPTICUM</i> , sp. nov.	285
1. Basal portion of a leaf.	285
1 ^a . Portion of 1 magnified three diameters.	285
2. Restoration of the leaf, as made out from various fragments.	285



2

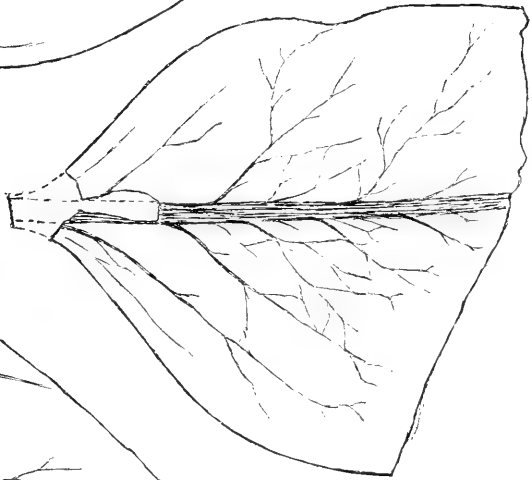

1

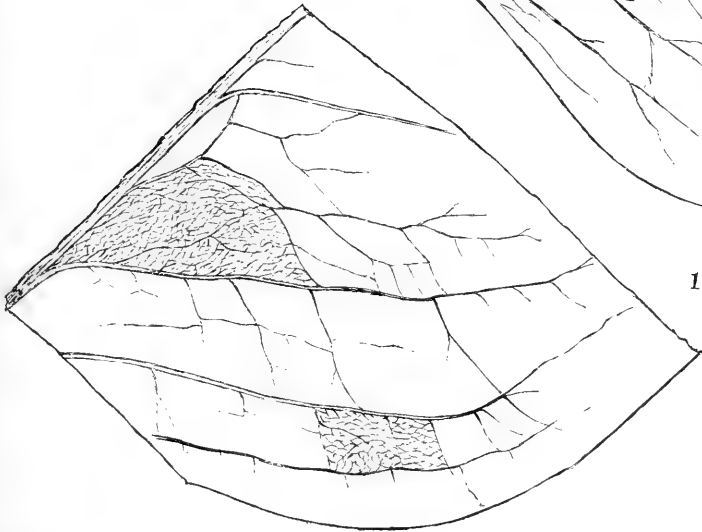

1^a

PLATE CXLIII.

PLATE CXLIII.

	Page.
FIGS. 1,3. <i>FICUS VIRGINIENSIS</i> , sp. nov	295
1. Fragment of a leaf	295
1 ^a . Portion of 1 magnified three diameters	295
3. Restoration of the leaf as made out from various fragments	295
FIG. 2. <i>ROGERSIA ANGUSTIFOLIA</i> , sp. nov	288
2. Leaf nearly complete	288
2 ^a . Portion of 2 magnified three diameters	288

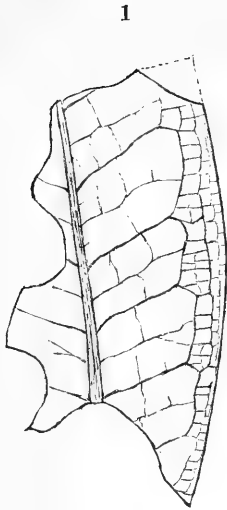

1^a

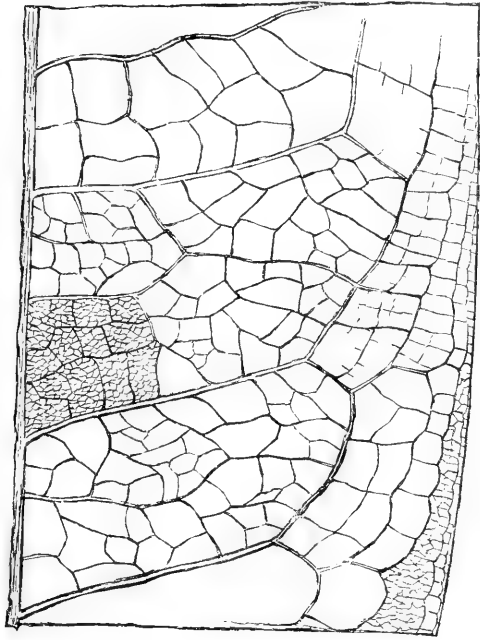

3

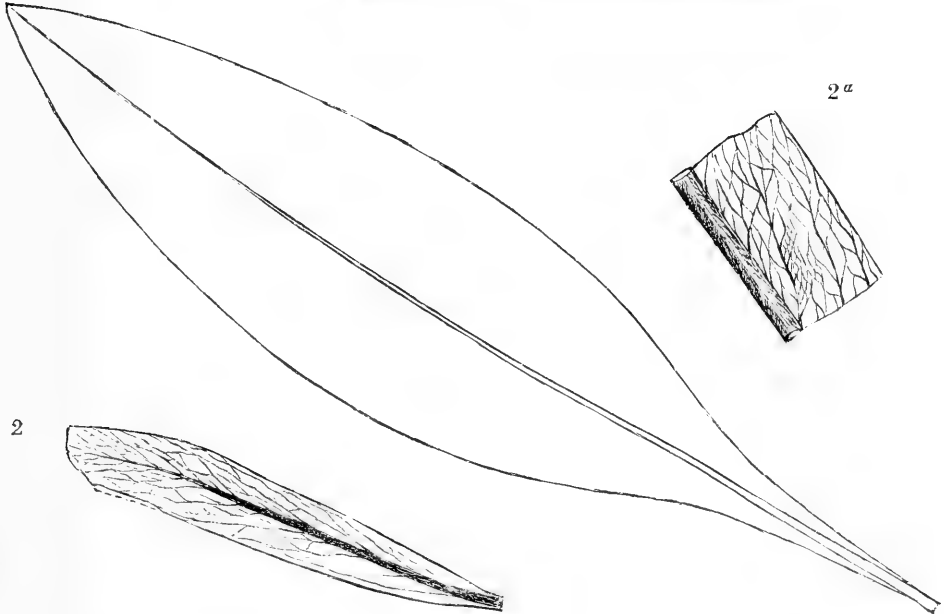

2^a

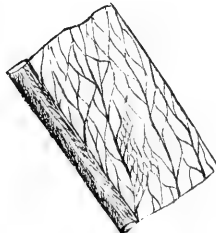

2

PLATE CXLIV.

PLATE CXLIV.

	Page.
FIG. 1. <i>FICUS VIRGINIENSIS</i> , sp. nov.	295
1. Upper part of a leaf	295
1 ^a . Portion of 1 magnified three diameters	295
FIG. 2. <i>ROGERSIA LONGIFOLIA</i> , sp. nov.	287
2. Middle portion of a leaf	287
2 ^a . Portion of 2 magnified three diameters	287
2 ^b . Portion of 2 magnified more than 2 ^a , to show the ultimate reticulation	287
FIG. 3. <i>FICOPHYLLUM CRASSINERVE</i> , sp. nov.	291
3. Upper portion of a large leaf	291

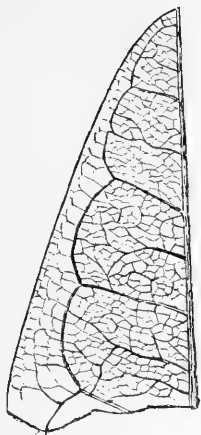

1^a

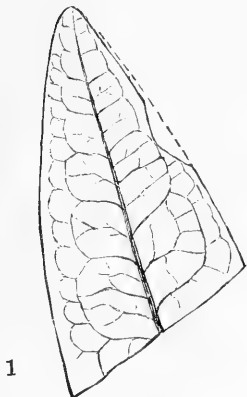

1

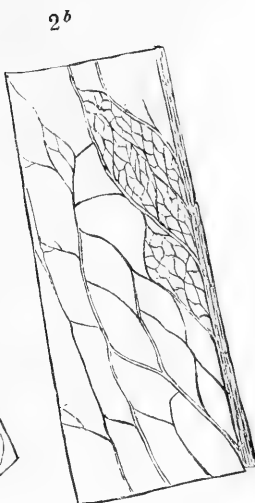

2^b



2



2^a

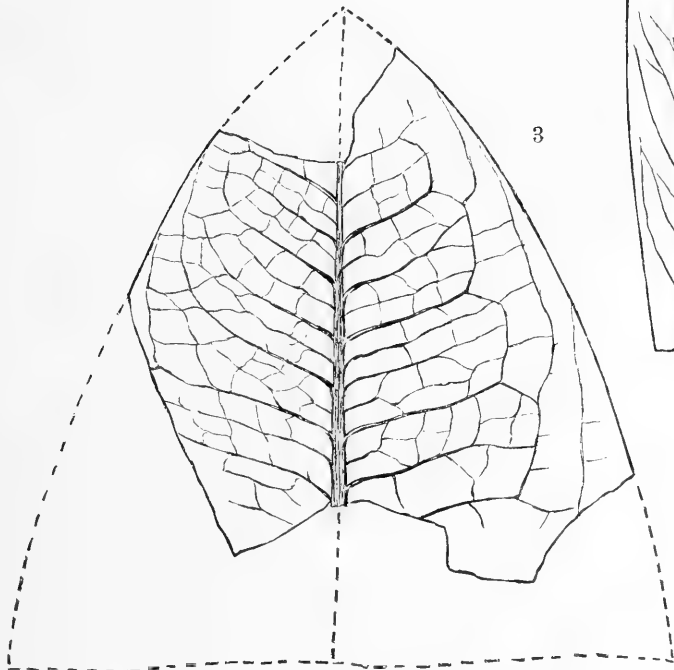

3

PLATE CXLV.

P L A T E C X L V .

		Page.
Figs. 1, 4.	FICOPHYLLUM TENUINERVE, sp. nov	292
	1. Tip of a large leaf	292
	4. Restoration of <i>Ficophyllum tenuinerve</i> as made out from numerous fragments	292
Fig.	2. FICOPHYLLUM SERRATUM, sp. nov	294
	2. Upper part of a leaf	294
Fig.	3. FICOPHYLLUM CRASSINERVE, sp. nov	291
	3. Fragment of a leaf of medium size	291

1

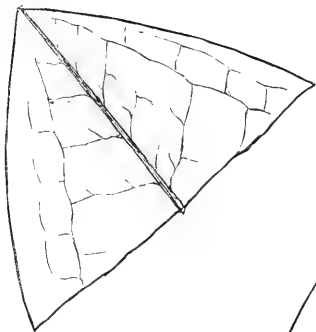

2

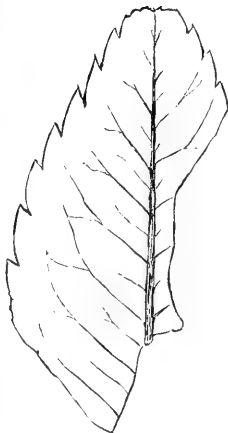

3



4

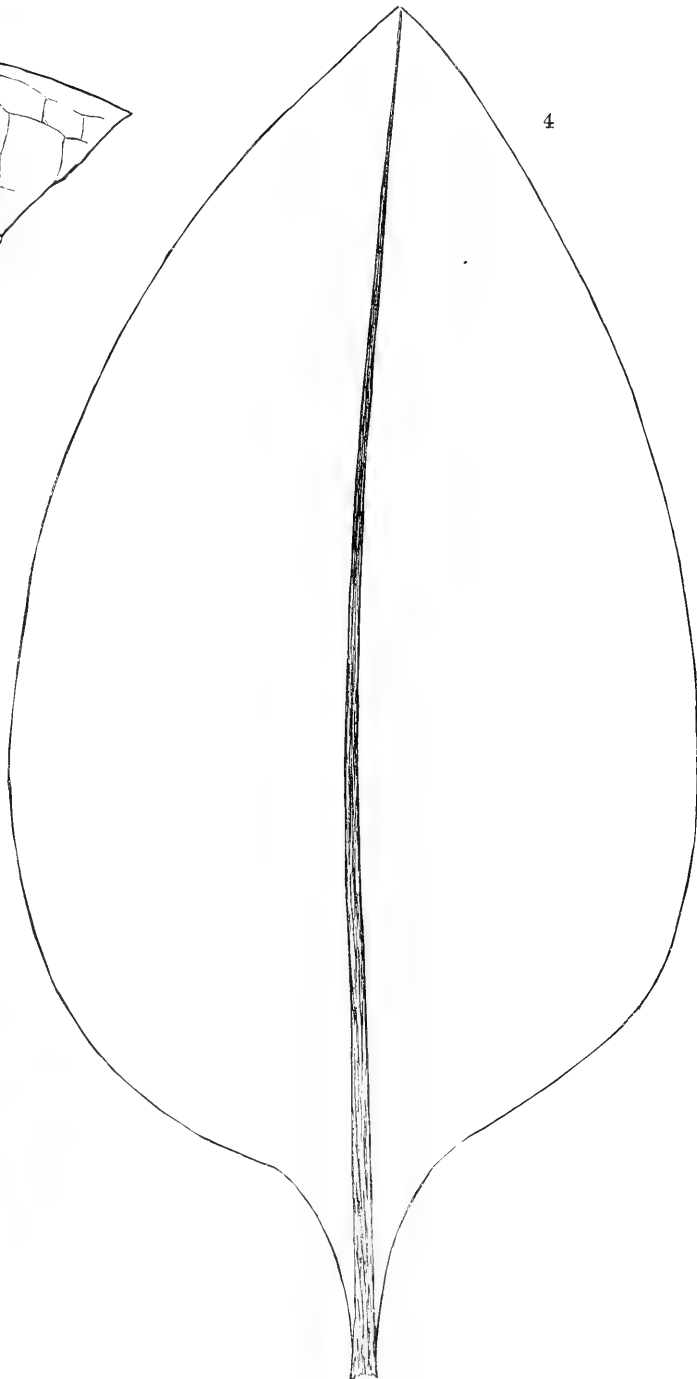

PLATE CXLVI.

PLATE CXLVI.

	Page.
FIG. 1. <i>FICOPHYLLUM CRASSINERVE</i> , sp. nov	291
1. Small fragment of a leaf.....	291
1a. Portion of 1 magnified three diameters.....	291
FIGS. 2, 4. <i>SALICIPHYLLUM ELLIPTICUM</i> , sp. nov	303
2. Fragment of the basal portion of a leaf.....	303
4. Fragment of the upper part of a leaf.....	303
FIG. 3. <i>CELASTROPHYLLUM ARCINERVE</i> , sp. nov	304
3. Portion of the lower part of a leaf	304
3a. Part of 3 magnified three diameters	304
FIG. 5. <i>CELASTROPHYLLUM PROTEOIDES</i> , sp. nov	304
5. Nearly entire leaf	304

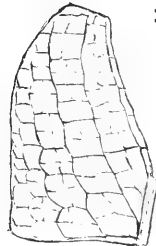
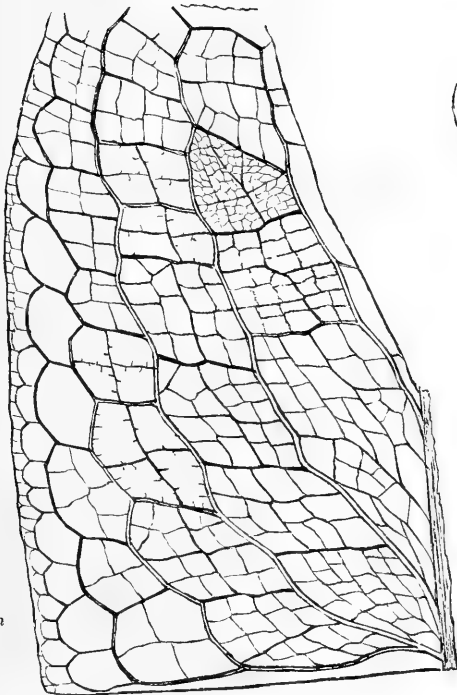
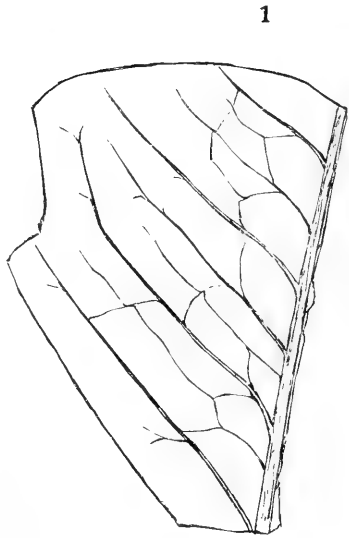
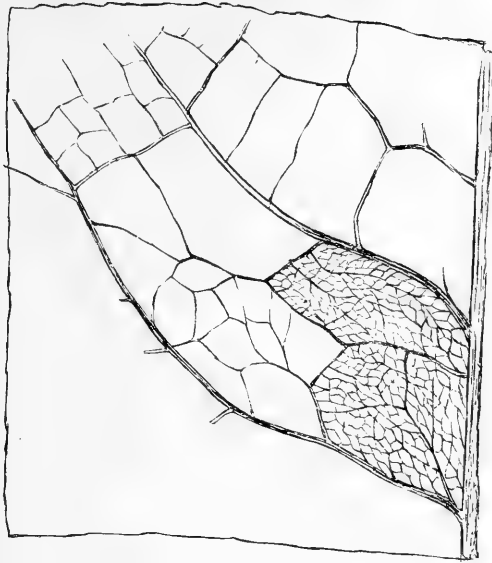

PLATE CXLVII.

PLATE CXLVII.

	Page.
FIG. 1. <i>SAPINDOPSIS CORDATA</i> , sp. nov.	296
1. Nearly entire leaf	296
FIG. 2. <i>FICOPHYLLUM TENUINERVE</i> , sp. nov.	292
2. Tip of a large leaf	292
FIG. 3. <i>SAPINDOPSIS ELLIPTICA</i> , sp. nov.	297
3. Middle portion of a leaf.	297
3a. Part of 3 magnified three diameters	297
FIG. 4. <i>FICOPHYLLUM CRASSINERVE</i> , sp. nov.	291
4. Fragment of a very large leaf, natural size.	291

1



3^a

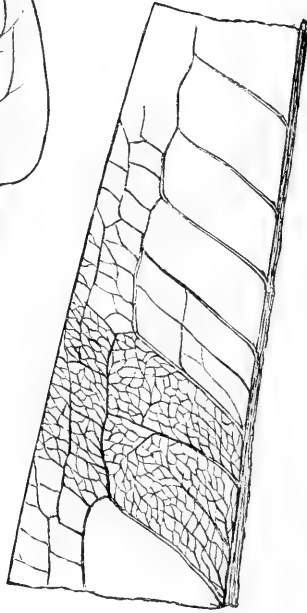

3

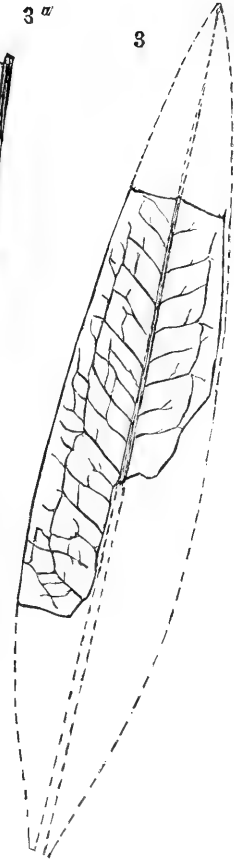

2



4

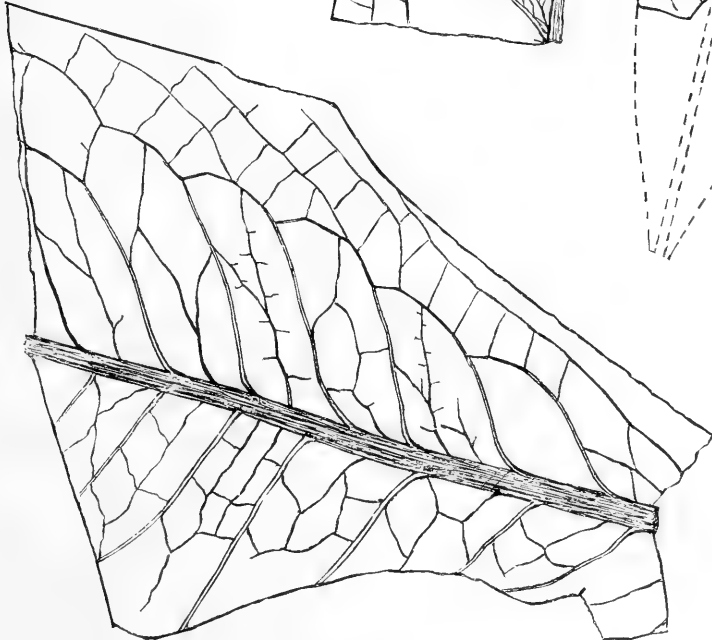

PLATE CXLVIII.

PLATE CXLVIII.

	Page.
FIGS. 1, 2, 4. <i>FICOPHYLLUM CRASSINERVE</i> , sp. nov.	291
1. Middle part of a leaf	291
2. Basal part of a leaf	291
4. Fragment of a large leaf	291
FIGS. 3, 5. <i>FICUS FREDERICKSBURGENSIS</i> , sp. nov.	295
3. Fragment of the middle portion of a leaf	295
5. Summit of a small leaf	295

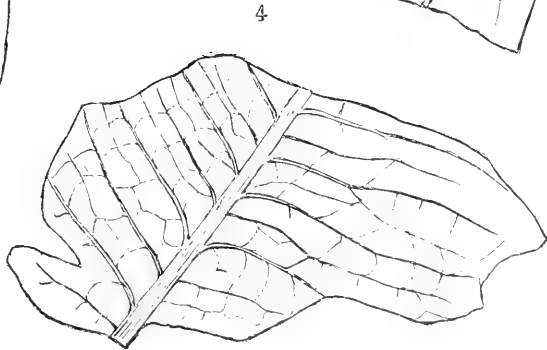
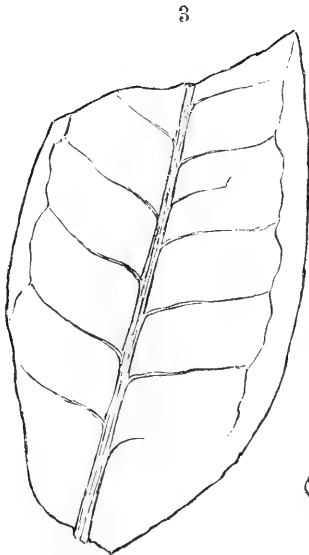
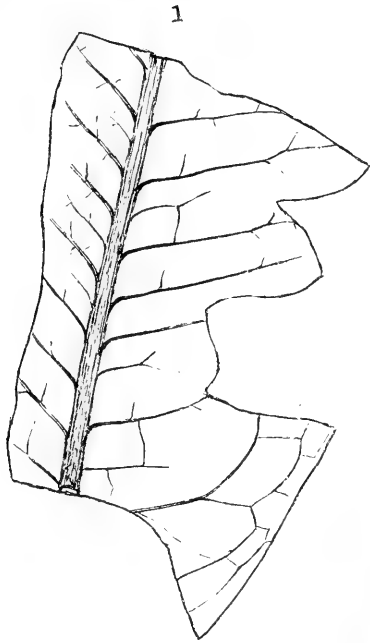

PLATE CXLIX.

PLATE CXLIX.

		Page.
FIGS. 1, 3, 5.	FIG. 1. <i>FICOPHYLLUM TENUINERVE</i> , sp. nov.	292
	2. Fragment of a leaf.	292
	3. Basal portion of a narrow leaf.	292
	5. Basal portions of two leaves apparently once connected by attachment to the same twig.	292
FIG.	2. <i>PHYLLITES PACHYPHYLLUS</i> , sp. nov.	325
	2. Fragment from the middle part of a leaf.	325
FIGS.	4, 8. <i>ROGERSIA ANGUSTIFOLIA</i> , sp. nov.	288
	4. Nearly entire leaf.	288
	4 ^a . Portion of 4 magnified three diameters.	288
	8. Fragment of a narrow leaf.	288
	8 ^a . Portion of 8 enlarged three diameters.	288
FIGS.	6, 7. <i>QUERCOPHYLLUM TENUINERVE</i> , sp. nov.	308
	6. Small leaf nearly entire.	308
	7. Basal portion of a large leaf.	308
FIG.	9. <i>FICOPHYLLUM SERRATUM</i> , sp. nov.	294
	9. Upper part of a leaf.	294

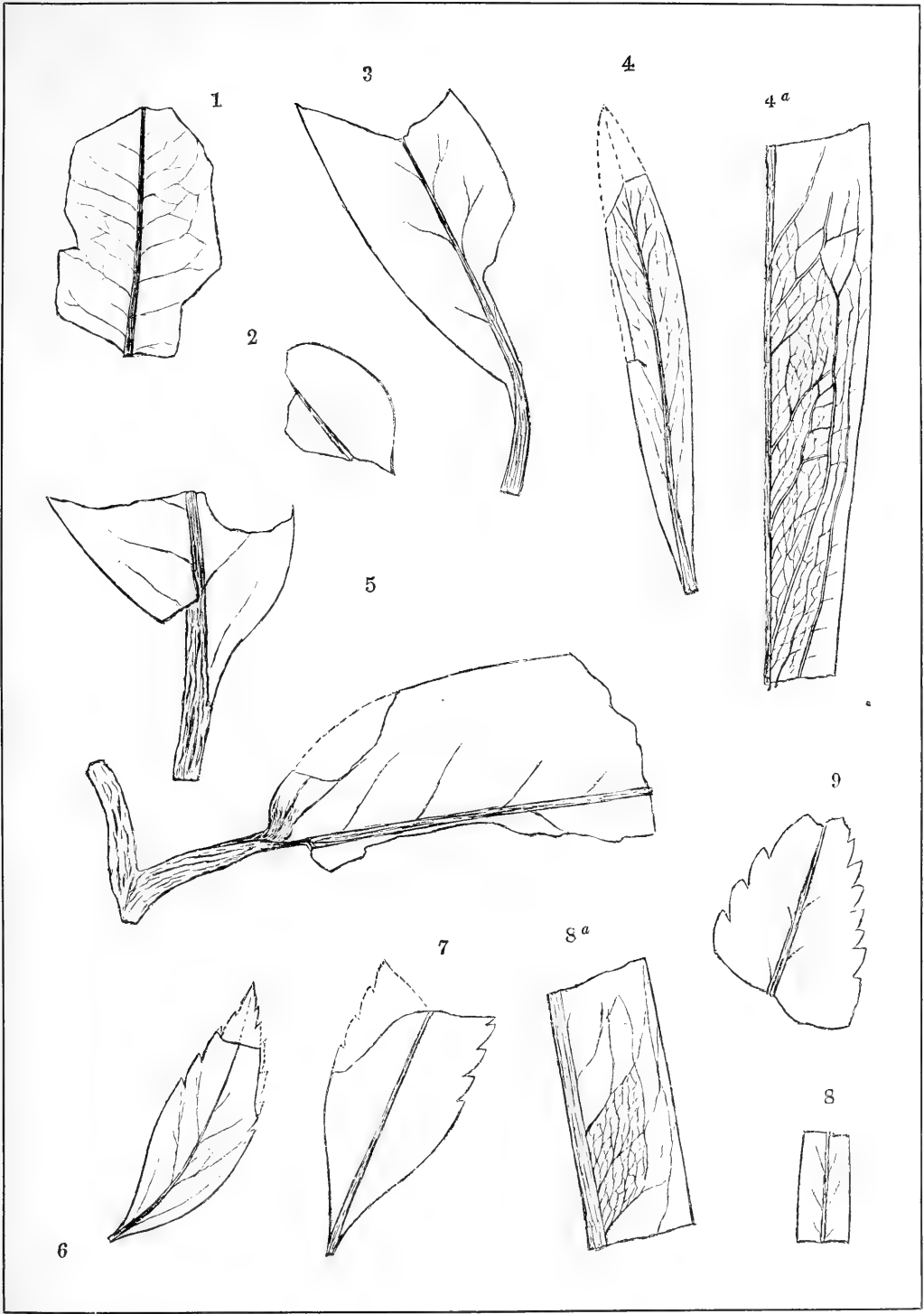

PLATE CL.

PLATE CL.

	Page.
FIG. 1. <i>ROGERSIA LONGIFOLIA</i> , sp. nov.	287
1. Basal portion of an unusually large leaf.....	287
FIGS. 2-7. <i>ROGERSIA ANGUSTIFOLIA</i> , sp. nov.	288
2, 3, 6. Basal portions of leaves.....	288
4. Upper part of a leaf.....	288
5. Tip and upper part of a leaf.....	288
7. Entire small leaf.....	288
FIG. 8. <i>SALICIPHYLLUM ELLIPTICUM</i> , sp. nov.	303
8. A nearly entire leaf.....	303
FIGS. 9, 10. <i>VITIPHYLLUM (CISSITES) CRASSIFOLIUM</i> , sp. nov.	308
9, 10. Portions of the summit of the leaves or of primary segments.....	308
FIG. 11. <i>MYRICA BROOKENSIS</i> , sp. nov.	310
11. Two entire leaves attached to the stem.....	310
FIG. 12. <i>SALICIPHYLLUM LONGIFOLIUM</i> , sp. nov.	302
12. Basal portion of a leaf.....	302
12 ^a . Part of 12 magnified three diameters.....	302
FIG. 13. <i>PROTEPHYLLUM TENUINERVE</i> , sp. nov.	286
13. Fragment of apparently the middle part of the leaf.....	286

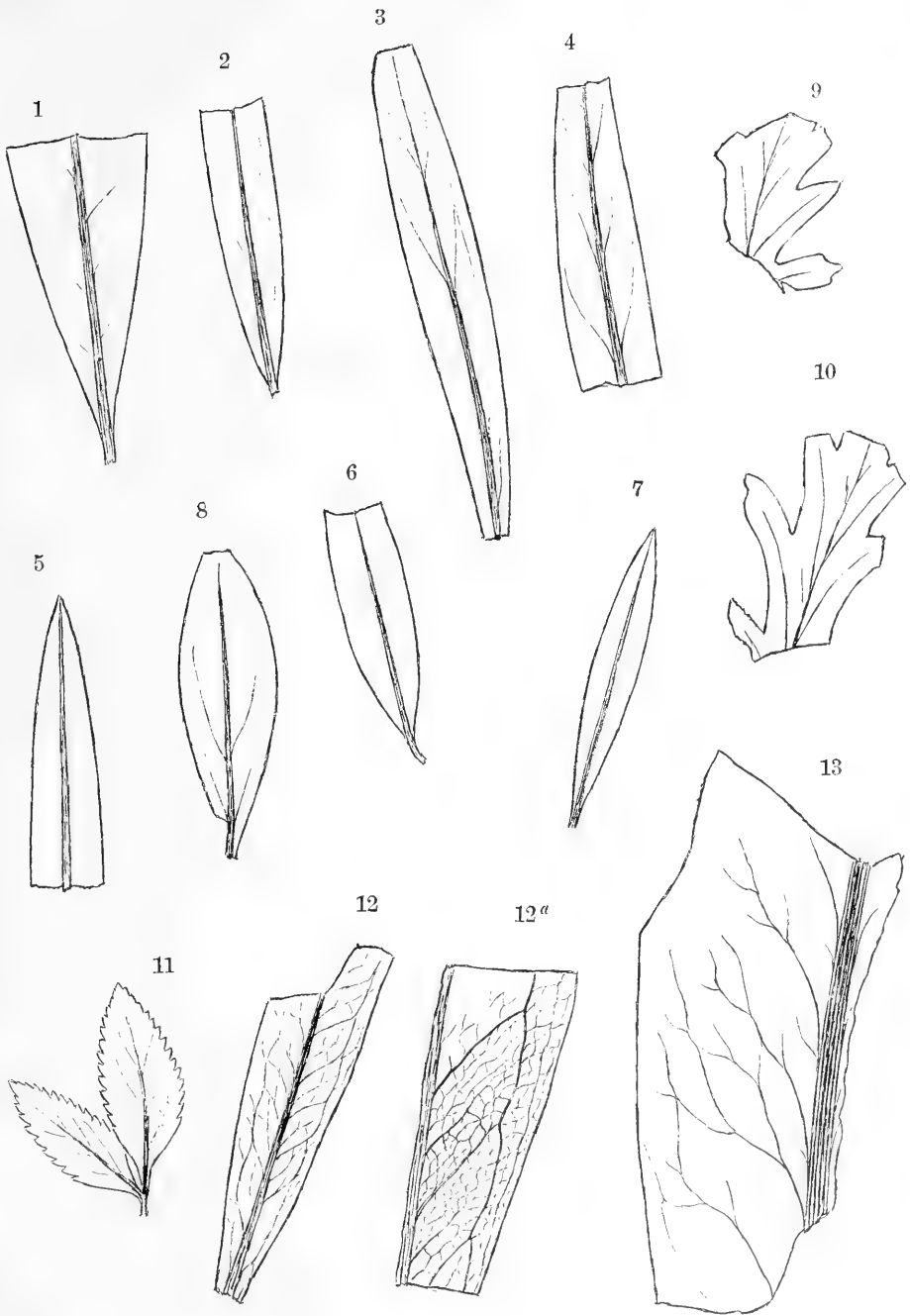
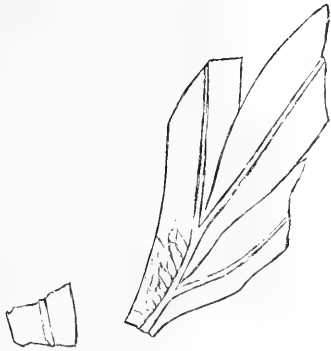

PLATE CLI.

PLATE CLI.

	Page.
FIG. 1. <i>SAPINDOPSIS VARIABILIS</i> , sp. nov	298
1. Upper part of a compound leaf.....	298
1 ^a . Portion of 1 magnified to show nervation.....	298
FIGS. 2, 3. <i>SAPINDOPSIS MAGNIFOLIA</i> , sp. nov.....	297
2. Upper portion of a compound leaf.....	297
3. Several leaflets detached.....	297
FIG. 4. <i>BOMBAX VIRGINIENSIS</i> , sp. nov	310
4. Lower portion of a leaf	310

1



1^a

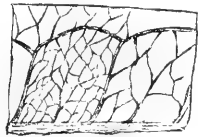

2

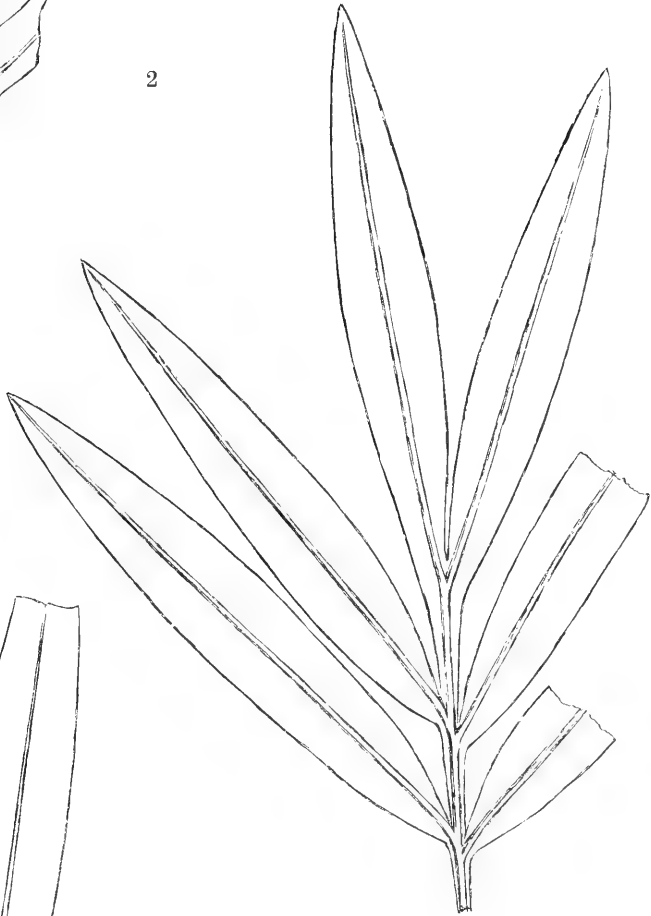

3



4

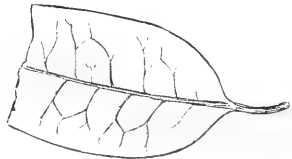

PLATE CLII.

PLATE CLII.

	Page.
FIGS. 1, 4. <i>SAPINDOPSIS VARIABILIS</i> , sp. nov	298
1. Upper part of a small compound leaf	298
4. Fragments from the upper part of a compound leaf	298
4*. Portion of 4 magnified three diameters	298
FIGS. 2, 3. <i>SAPINDOPSIS MAGNIFOLIA</i> , sp. nov	297
2. Summit of a large compound leaf	297
3. Fragments of very large leaflets	297
FIG. 5. <i>SASSAFRAS CRETACEUM</i> Newb., var. <i>HETEROLOBUM</i>	289
5. Entire leaf.....	289

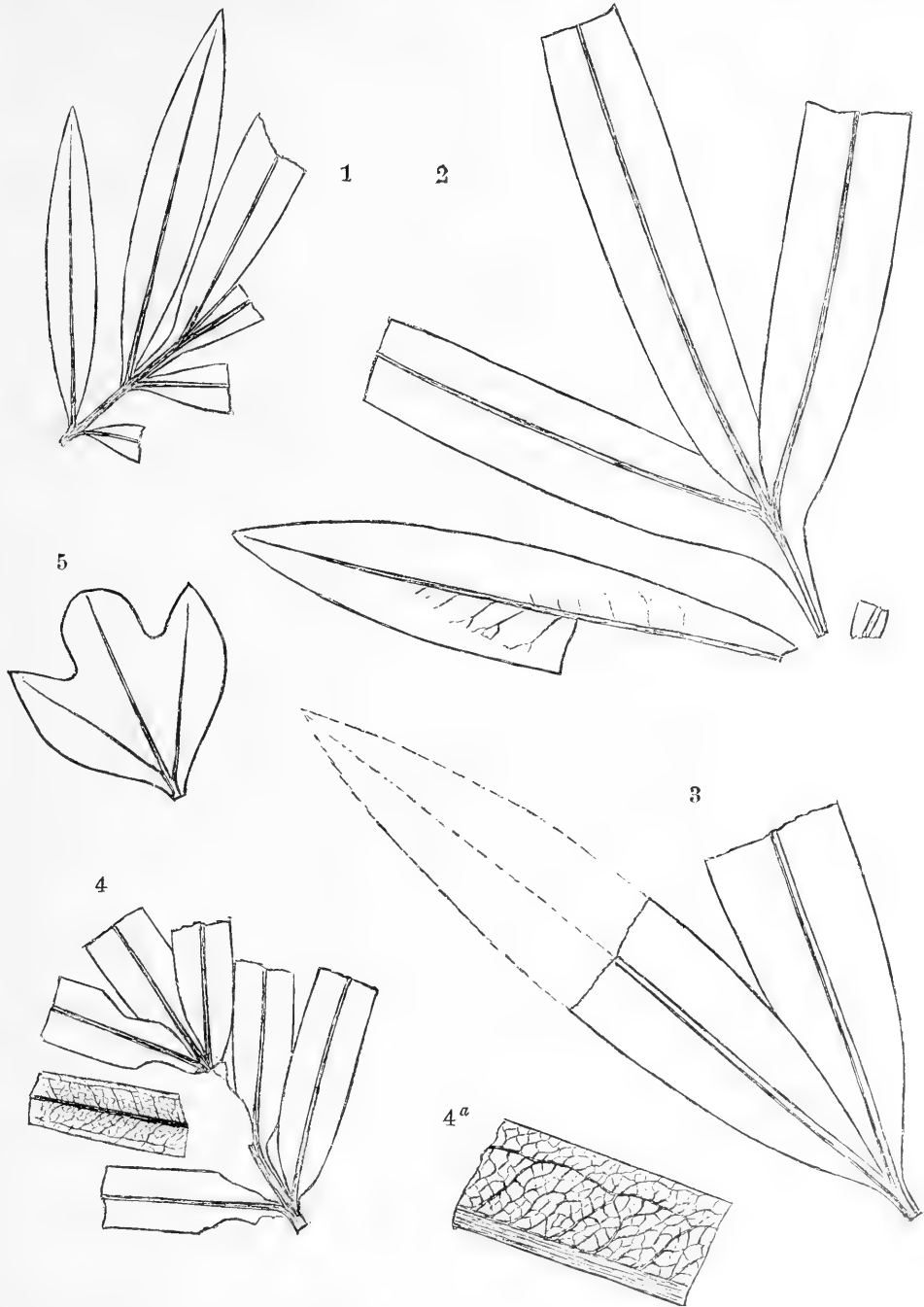
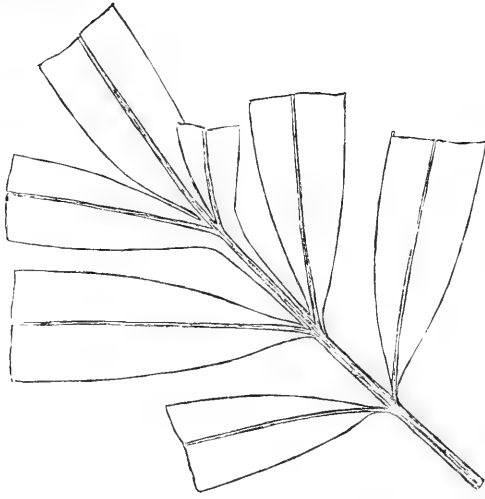

PLATE CLIII.

PLATE CLIII.

	Page.
FIG. 1. <i>SAPINDOPSIS TENUINERVIS</i> , sp. nov.	301
1. Upper part of a compound leaf	301
1a. Portion of the base of a leaflet magnified three diameters	301
1b. Portion of the middle of a leaflet magnified three diameters	301
FIG. 2. <i>SAPINDOPSIS MAGNIFOLIA</i> , sp. nov.	297
2. Upper part of a large compound leaf	297
FIG. 3. <i>SAPINDOPSIS VARIABILIS</i> , sp. nov.	298
3. Fragment of a compound leaf	298
FIG. 4. <i>SAPINDOPSIS BREVIFOLIA</i> , sp. nov.	300
4. Summit of a compound leaf	300

1



1^b



3



2

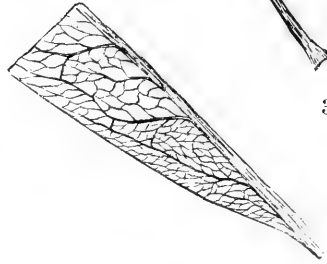

1^a

4



PLATE CLIV.

PLATE CLIV.

	Page.
FIGS. 1, 5. <i>SAPINDOPSIS MAGNIFOLIA</i> , sp. nov.	297
1. Upper part of a small compound leaf.	297
1 ^a . Portion of a leaflet magnified three diameters	297
5. Portions of two leaflets	297
FIGS. 2-4. <i>SAPINDOPSIS VARIABILIS</i> , sp. nov.	298
2. Upper part of an abnormal compound leaf	298
3. Summit of a small abnormal compound leaf	298
4. Portion of the upper part of an abnormal compound leaf.....	298
4 ^a . Portion of a leaflet of 4 magnified three diameters.....	298
FIG. 6. <i>SAPINDOPSIS PARVIFOLIA</i> , sp. nov.	300
6. Upper part of a compound leaf.	300

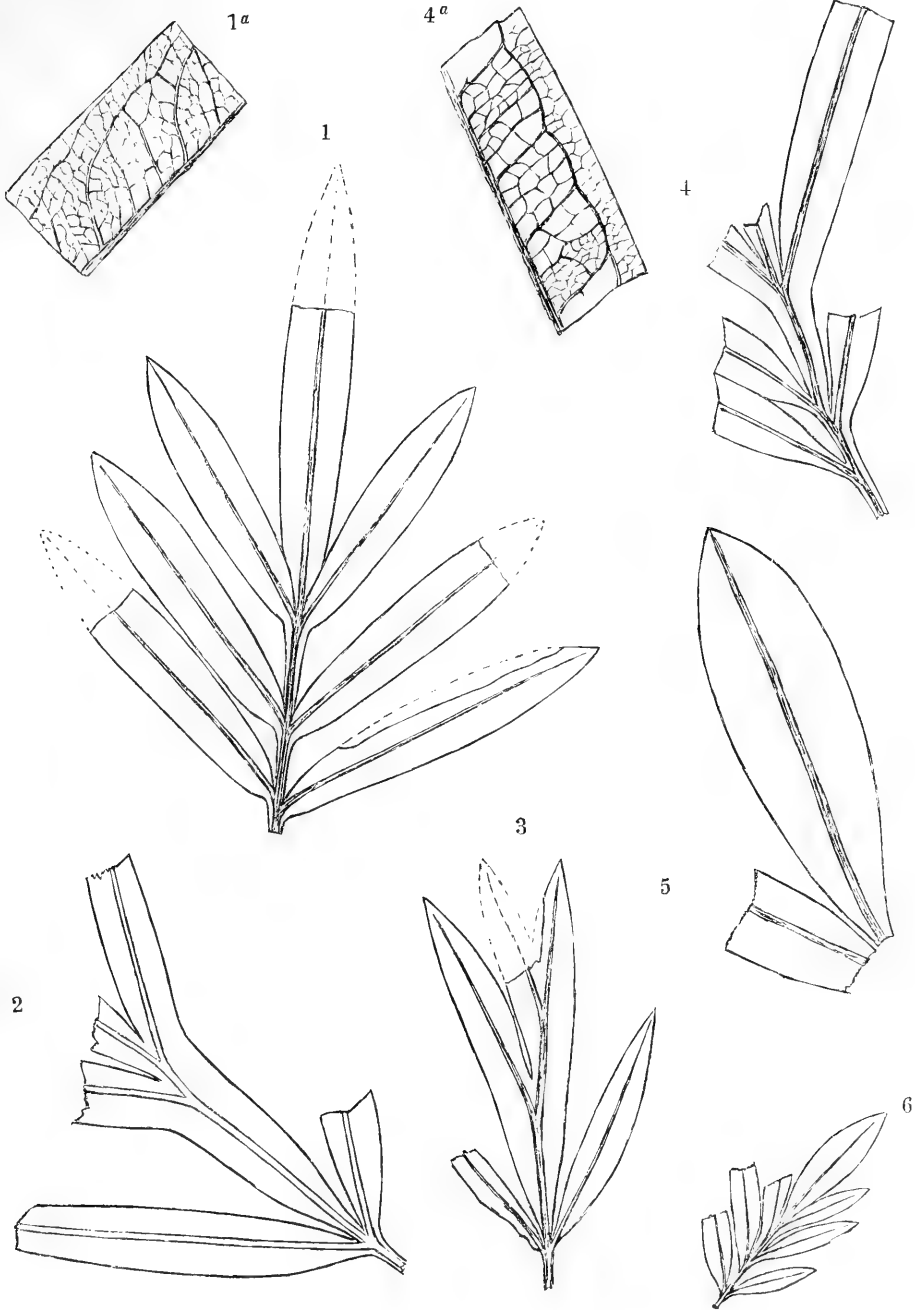

PLATE CLV.

P L A T E C L V.

	Page.
FIGS. 1,7. <i>SAPINDOPSIS BREVIFOLIA</i> , sp. nov.	300
1. Upper part of a compound leaf	300
7. Portion of the upper part of a compound leaf	300
FIGS. 2-5. <i>SAPINDOPSIS VARIABILIS</i> , sp. nov.	298
2. Upper portion of an unusually small compound leaf	298
3. Upper part of a small compound leaf	298
4. Fragments of the upper part of an abnormal compound leaf	298
5. Portion of the upper part of a compound leaf	298
FIG. 6. <i>SAPINDOPSIS MAGNIFOLIA</i> , sp. nov.	297
6. Upper part of a compound leaf	297
6 ^a . A portion magnified	297
FIG. 8. <i>ULMIPHYLLUM BROOKENSE</i> , sp. nov.	312
8. Fragment of the basal part of a leaf	312
FIG. 9. <i>POPULOPHYLLUM RENIFORME</i> , sp. nov.	311
9. Fragment of a leaf	311
9 ^a . Portion of 9 magnified three diameters	311

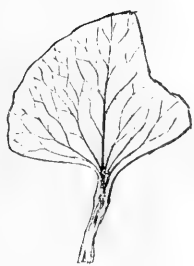
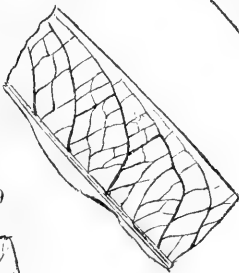
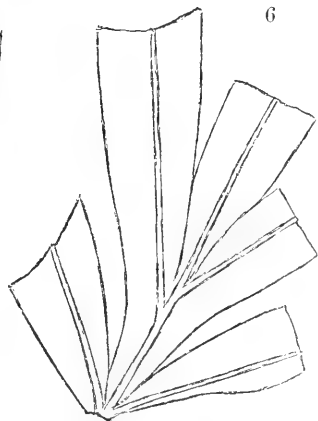
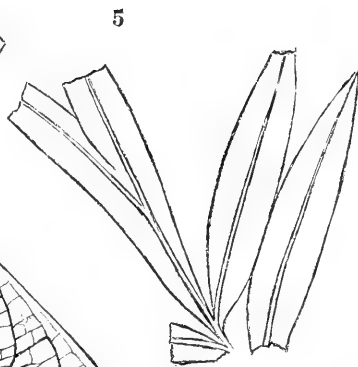
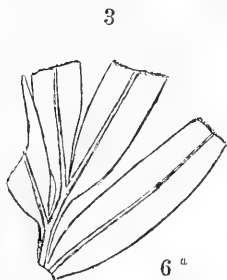
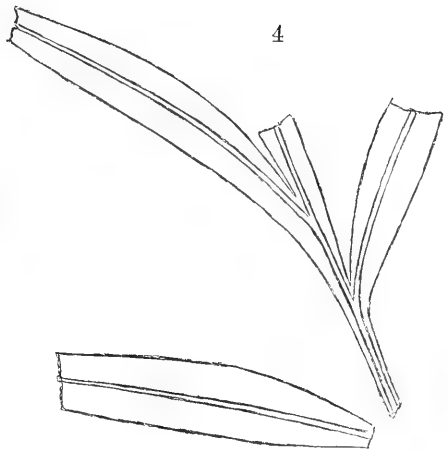



PLATE CLVI.

PLATE CLVI.

	Page.
FIG. 1. <i>FICOPHYLLUM TENUINERVE</i> , sp. nov.	292
1. Small fragment of a leaf	292
FIG. 2. <i>PROTEOPHYLLUM TENUINERVE</i> , sp. nov.	286
2. Small fragment of a leaf	286
FIG. 3. <i>POPULOPHYLLUM RENIFORME</i> , sp. nov.	311
3. Fragment of a small leaf	311
FIG. 4. <i>PROTEOPHYLLUM RENIFORME</i> , sp. nov.	282
4. Small fragment of a leaf	282
FIG. 5. <i>CELASTROPHYLLUM OBTUSIDENS</i> , sp. nov.	305
5. Fragment with the margin mostly wanting	305
FIG. 6. <i>MYRICEOPHYLLUM DENTATUM</i> , sp. nov.	316
6. Fragments of two leaves	316
FIG. 7. <i>PROTEOPHYLLUM DENTATUM</i> , sp. nov.	286
7. Small fragment of a leaf	286
FIG. 8. <i>CELASTROPHYLLUM ACUTIDENS</i> , sp. nov.	305
8. Fragment of a leaf	305
8 ^a . Portion of 8 magnified three diameters	305
FIG. 9. <i>QUERCOPHYLLUM GROSSEDENTATUM</i> , sp. nov.	307
9. Fragment of a leaf	307
FIG. 10. <i>MYRICA BROOKENSIS</i> , sp. nov.	319
10. Basal portion of a leaf	310
10 ^a . Portion of 10 magnified three diameters	310
FIG. 11. <i>ARALLEOPHYLLUM ACEROIDES</i> , sp. nov.	319
11. Fragment of a large leaf	319
FIG. 12. <i>SASSAFRAS BILOBATUM</i> , sp. nov.	290
12. Fragment of a leaf	290
FIG. 13. <i>SAPINDOPSIS OBTUSIFOLIA</i> , sp. nov.	301
13. Small portion of a leaf	301

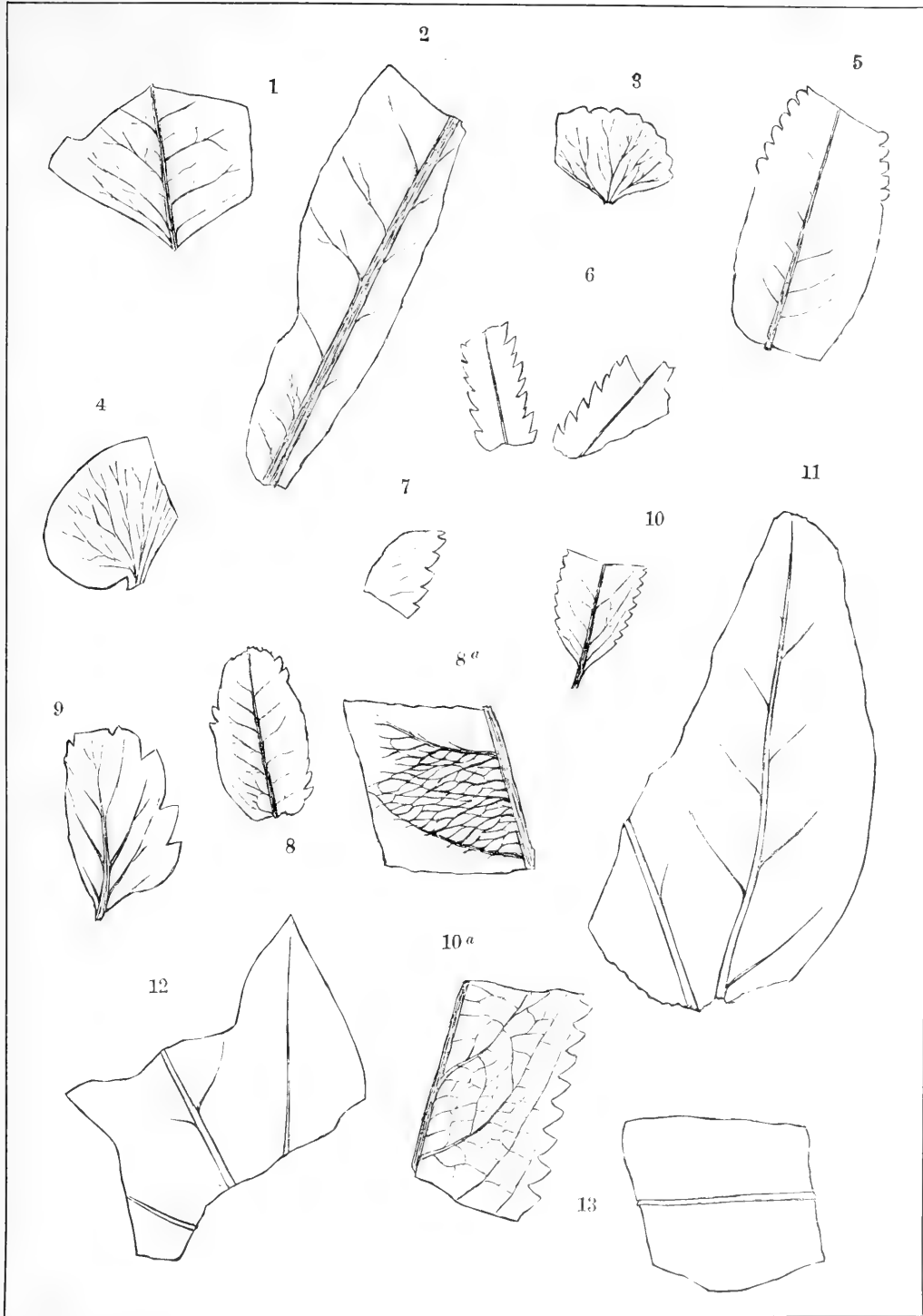

PLATE CLVII.

PLATE CLVII.

	Page.
FIGS. 1,7. <i>ARALIA DUBIA</i> , sp. nov.	314
1. Summit of a lobe	314
7. Fragment of a leaf.	314
FIG. 2. <i>STERCULIA ELEGANS</i> , sp. nov.	314
2. Restoration of the leaf as made out from fragments.	314
FIGS. 3,5,6. <i>JUGLANDIPHYLLUM INTEGRIFOLIUM</i> , sp. nov.	315
3. Small fragment of a leaf	315
5,6. Upper portions of leaves of varying size	315
6 ^a . Portion of 6 magnified three diameters	315
FIG. 4. <i>FICOPHYLLUM CRASSINERVE</i> , sp. nov.	291
4. Tip of a leaf	291

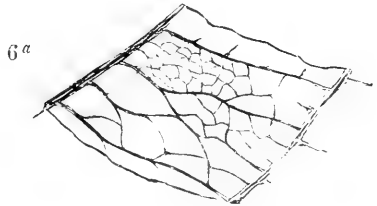
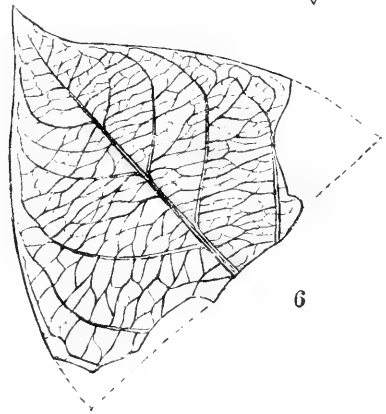
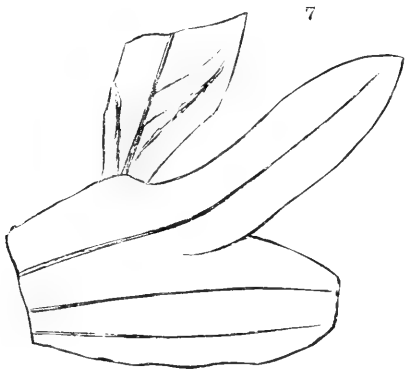
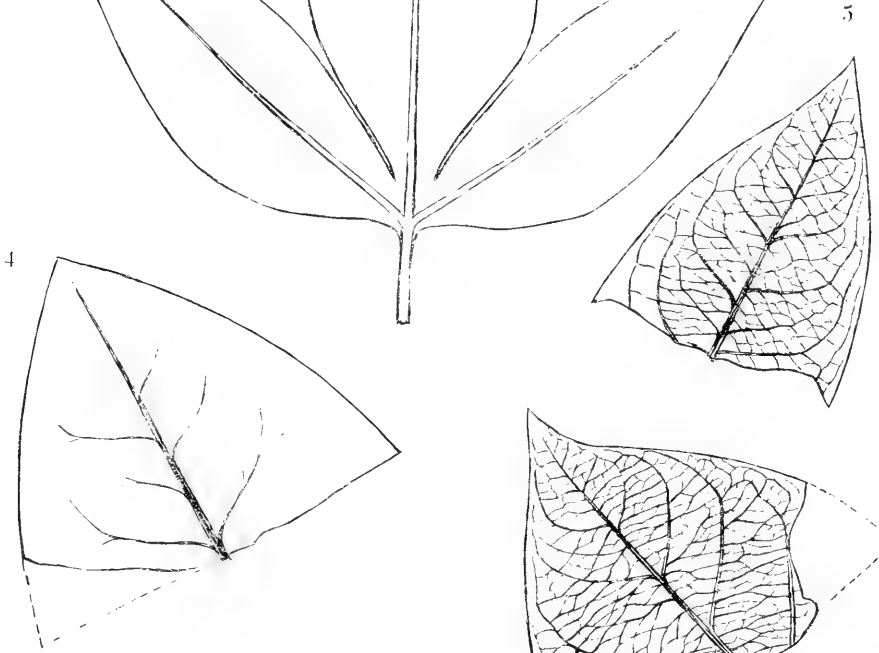
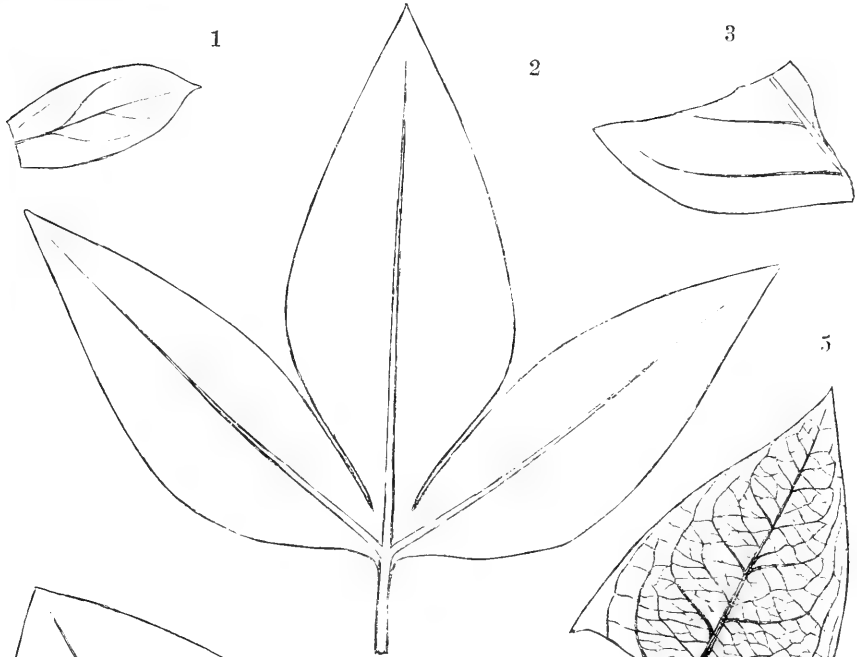

PLATE CLVIII.

PLATE CLVIII.

	Page.
FIG. 1. <i>ULMIPHYLLUM TENUINERVE</i> , sp. nov.	313
1. Small fragment of a leaf.	313
1 ^a . Portion of 1 magnified three diameters.	313
FIGS. 2, 3. <i>STERCULIA ELEGANS</i> , sp. nov.	314
2. Fragment of a large leaf.	314
3. Portion of a small leaf.	314
FIG. 4. <i>POPULOPHYLLUM CRASSINERVE</i> , sp. nov.	312
4. Fragment of a large leaf.	312
FIG. 5. <i>PLATANOPHYLLUM CRASSINERVE</i> , sp. nov.	316
5. Fragment of a large leaf.	316
5 ^a . Portion of 5 magnified three diameters.	316
FIGS. 6, 7. <i>ULMIPHYLLUM CRASSINERVE</i> , sp. nov.	313
6, 7. Fragments of large leaves.	313
7 ^a . Portion of 7 magnified three diameters.	313
FIG. 8. <i>CELASTROPHYLLUM BROOKENSE</i> , sp. nov.	305
8. Fragment of a small leaf.	305

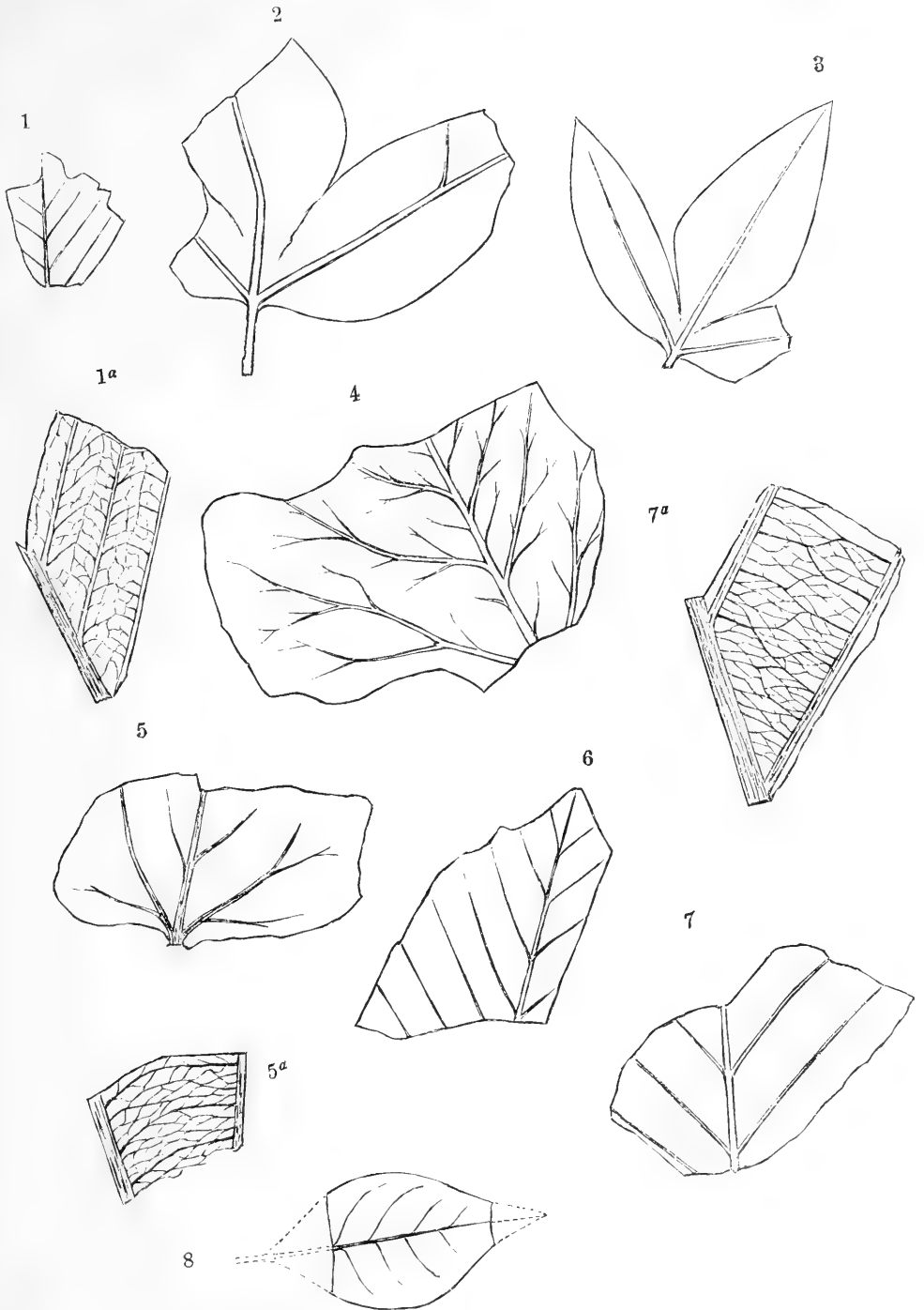

PLATE CLIX.

PLATE CLIX.

	Page.
FIGS. 1, 2. <i>ROGERSIA LONGIFOLIA</i> , sp. nov	287
1. Upper part of a leaf	287
2. Base of a leaf	287
FIGS. 3-6. <i>SAPINDOPSIS OBTUSIFOLIA</i> , sp. nov	301
3. Upper part of a leaf of the largest size	301
4. Fragment of a leaf	301
5. Summit of an inequilateral leaf	301
6. Upper part of a leaf	301
FIG 7. <i>CELASTROPHYLLUM BROOKENSE</i> , sp. nov	305
7. Base of a leaf of the largest size	305
FIG. 8. <i>SASSAFRAS CRETACEUM</i> (Newb.) var. <i>HETEROLOBUM</i>	289
8. Fragment of a leaf	289
FIGS. 9, 10. <i>ARALLEPHYLLUM MAGNIFOLIUM</i> , sp. nov	318
9, 10. Basal portions of large leaves	318

1



2



3

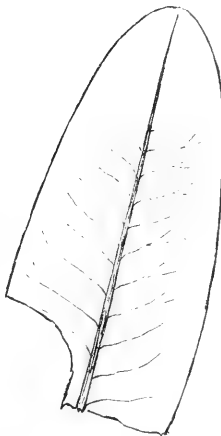

7

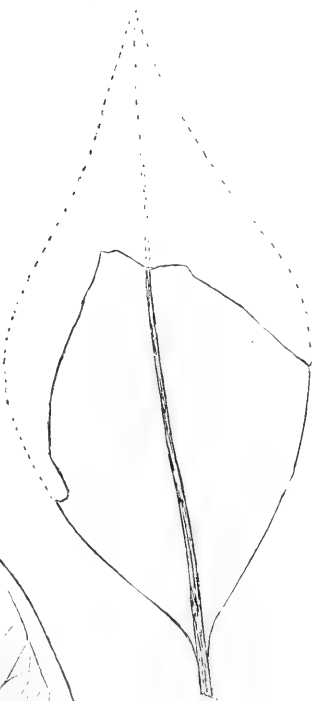

5

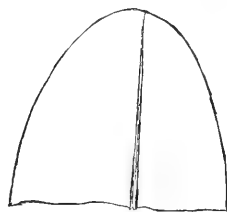

6

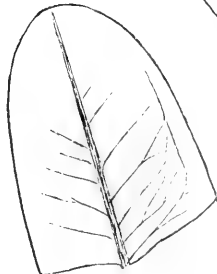

8



4



a



9

10

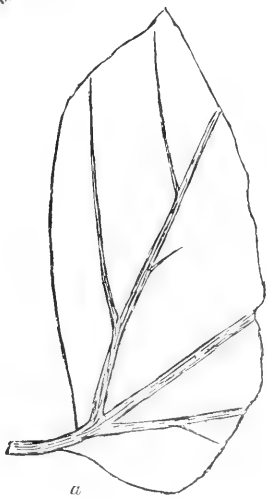

a

PLATE CLX.

PLATE CLX.

	Page.
FIGS. 1,2. <i>PROTŒPHYLLUM RENIFORME</i> , sp. nov	282
1. Fragment of a crumpled leaf	282
2. Restoration of the probable shape and size of the leaf.....	282
1 ^a . Portion of 1 magnified three diameters.....	282
FIGS. 3-6. <i>ARISTOLOCHLEPHYLLUM CRASSINERVE</i> , sp. nov	322
3. Fragment of probably the central part of the leaf.....	322
3 ^a . Portion of 3 magnified six diameters	322
4. Portion of leaf enlarged three diameters	322
5. Small fragment showing a primary nerve of large size.....	322
6. Fragment, probably from the left-hand basal portion of a leaf.....	322

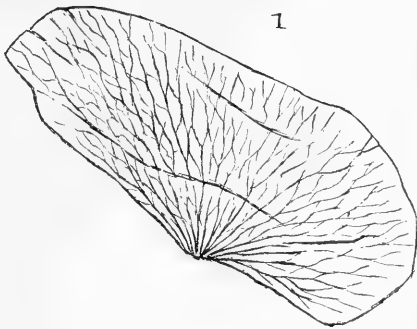

1

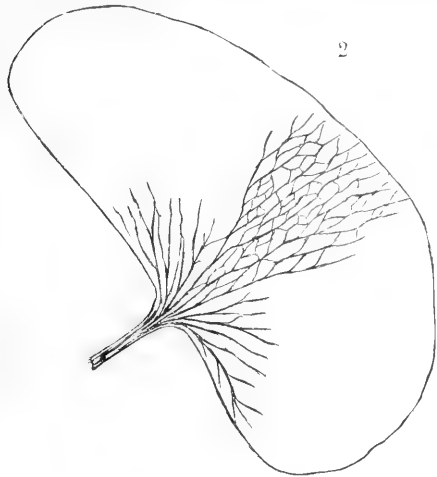

2

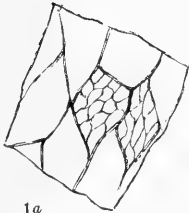

1a

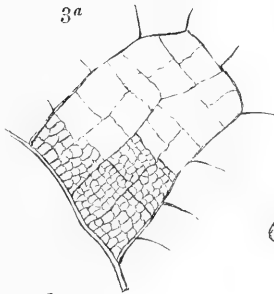

3a

4

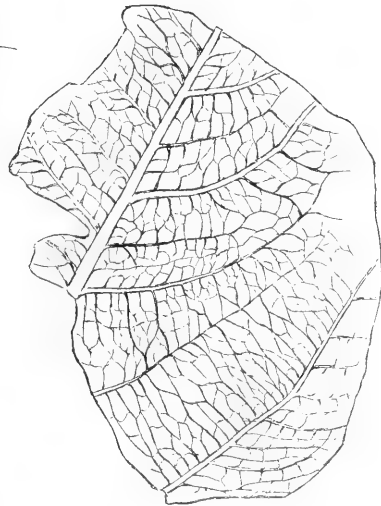

3b

6

5

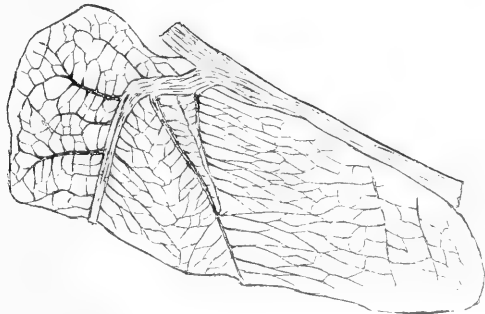
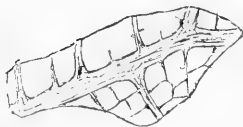
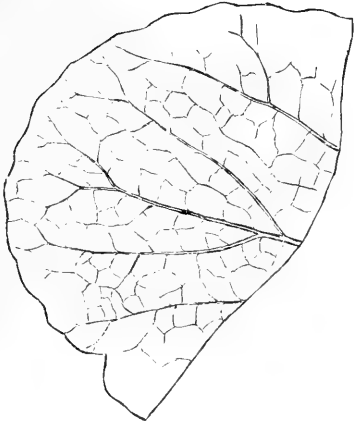

PLATE CLXI.

PLATE CLXI.

	Page.
FIGS. 1, 2. MENISPERMITES VIRGINIENSIS, sp. nov	321
1. Fragment of a leaf showing mainly the basal portion	321
1 ^a . Portion of 1 magnified three diameters	321
2. Summit of a smaller leaf	321

2



1

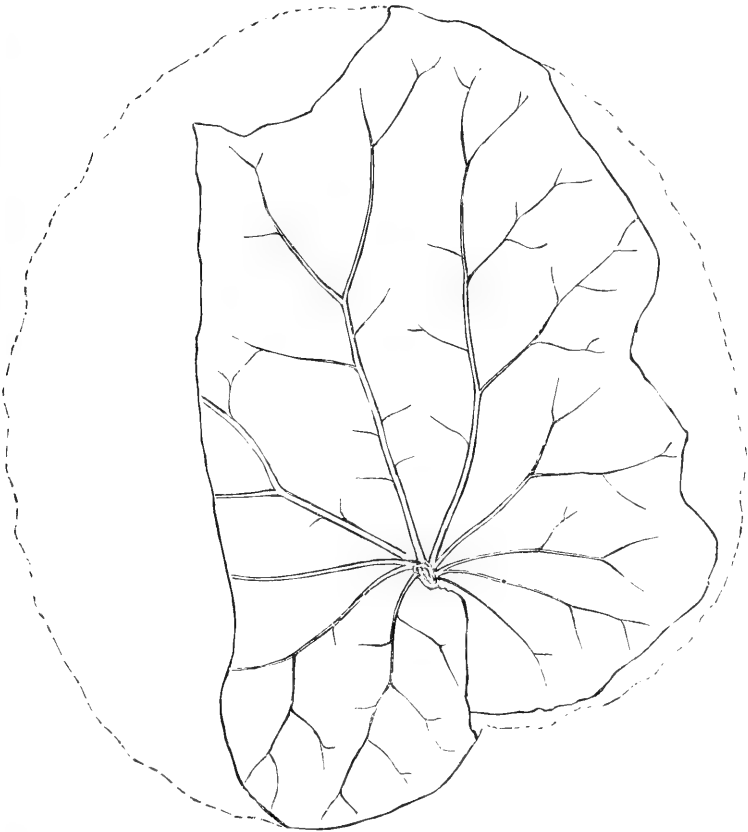
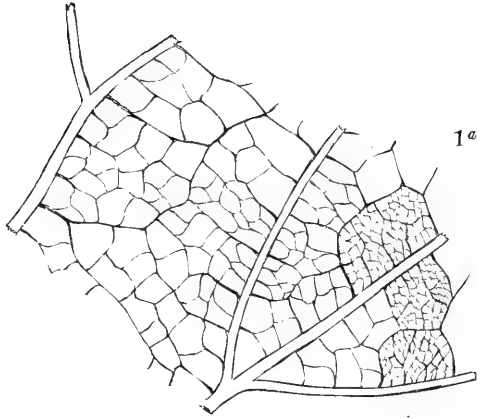
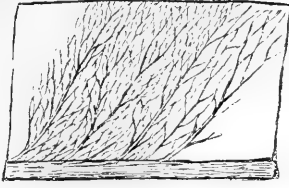

PLATE CLXII.

PLATE CLXII.

	Page.
FIG. 1. HEDERAPHYLLUM ANGULATUM, sp. nov.....	324
1. Nearly entire leaf	324
FIG. 2. ARALLEPHYLLUM ACEROIDES, sp. nov.....	319
2. Lower portion of a large leaf.....	319
FIG. 3. HEDERAPHYLLUM CRENULATUM, sp. nov.....	324
3. Nearly complete leaf	324
FIG. 4. EUCALYPTOPHYLLUM OBLONGIFOLIUM, sp. nov.....	325
4. Fragment of a leaf	325
4 ^a . Portion magnified to show nervation	325

4^a



1



2

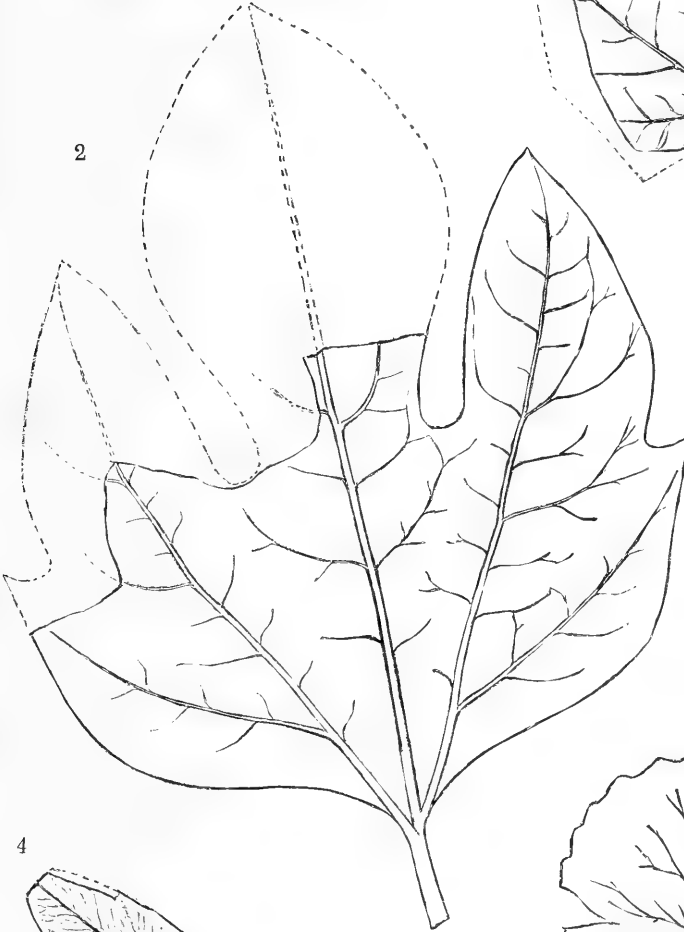

3

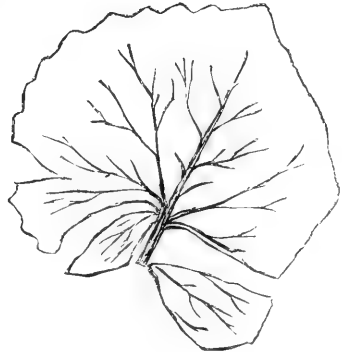

4

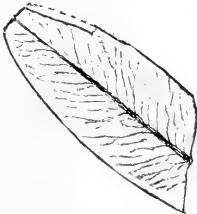
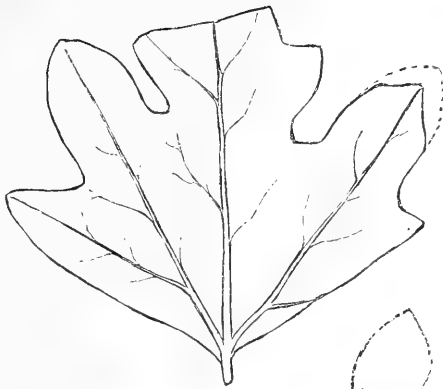

PLATE CLXIII.

PLATE CLXIII.

	Page.
FIGS. 1, 4. ARALLEPHYLLUM OBTUSILOBUM, sp. nov.	317
1. Nearly entire leaf	317
4. Fragment of a leaf with abnormally rounded base	317
FIG. 2. ARALLEPHYLLUM ACUTILOBUM, sp. nov.	318
2. Fragment of a small leaf	318
FIG. 3. SAPINDOPSIS BREVIFOLIA, sp. nov.	300
3. Summit of a compound leaf	300
FIG. 5. SALICIPHYLLUM ELLIPTICUM, sp. nov.	303
5. Entire leaf	303
FIG. 6. HYMENEA VIRGINIENSIS, sp. nov.	320
6. Bases of two leaves	320
FIG. 7. ULMIPHYLLUM BROOKENSE, sp. nov.	312
7. An entire leaf	312
7 ^a . Portion of 7 magnified three diameters	312
FIG. 8. ACERIPHYLLUM ARALOIDES, sp. nov.	321
8. Nearly entire leaf	321



1

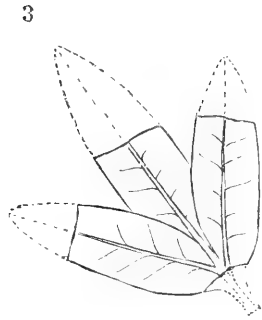

3

2

4



5

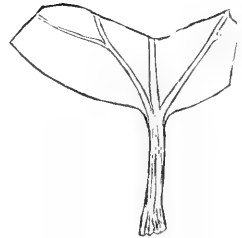

6



8



7

7^a

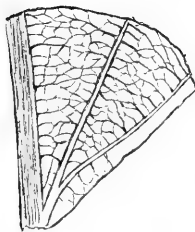

PLATE CLXIV

MON XV—45

PLATE CLXIV.

	Page.
FIGS. 1, 2. <i>FICOPHYLLUM EUCALYPTOIDES</i> , sp. nov.	294
1. Portions of two leaves probably once attached to the same stem	294
1 ^a . Portion of 1 magnified three diameters.....	294
2. Summit of a leaf	294
FIG. 3. <i>ARALLEPHYLLUM OBTUSILOBUM</i> , sp. nov.	317
3. Greater part of a leaf	317
FIG. 4. <i>SASSAPRAS BILOBATUM</i> , sp. nov.	290
4. Nearly complete leaf	290
FIG. 5. <i>SASSAPRAS CRETACEUM</i> , Newb., var <i>HETEROLOBUM</i>	289
5. Nearly entire leaf.....	289

1

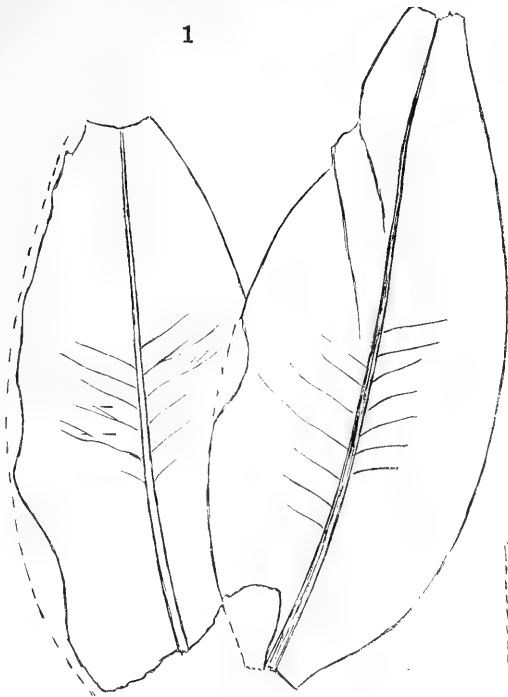

3



4



1^a

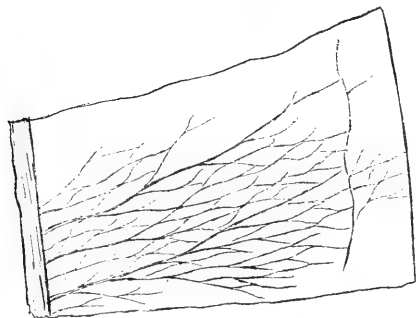

2

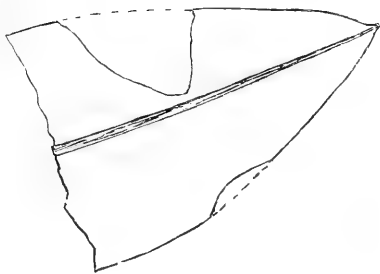

5



PLATE CLXV.

PLATE CLXV.

	Page.
FIGS. 1-3. TAXODIUM (GLYPTOSTROBUS) BROOKENSE, sp. nov.	254
1, 2. Narrow forms.....	254
3. Large branch and twigs of the narrowest form.....	254
FIG. 4. LARICOPSIS LONGIFOLIA, sp. nov.	233
4. Small fragment of a leafy twig	233
FIG. 5. WILLIAMSONIA VIRGINIENSIS, sp. nov.	273
5. Whorl of bracts, showing traces of hair-like appendages	273
FIG. 6. LEPTOSTROBUS (?) MULTIFLORUS, sp. nov.	230
6. Fragment of very long cone	230



PLATE CLXVI.

PLATE CLXVI.

		Page.
FIG. 1.	TAXODIUM (GLYPTOSTROBUS) RAMOSUM, sp. nov.	251
	1. Fragments of small twigs.....	251
	1 ^a . Portion of 1 magnified	251
FIG. 2.	SALICIPHYLLUM ELLIPTICUM, sp. nov.	303
	2. Lower portion of a leaf	303
FIG. 3.	POPULOPHYLLUM HEDEREFORME, sp. nov.	311
	3. Fragment of a leaf with large petiole	311
FIGS. 4, 7.	TAXODIUM (GLYPTOSTROBUS) BROOKENSE, sp. nov.	254
	4. Fragment of a very large branch	254
	7. Male inflorescence, probably of <i>Taxodium</i> (<i>Glyptostrobus</i>) <i>Brookense</i>	254
	4 ^a . Portion of an ultimate twig magnified	254
FIG. 5.	CLADOPHLEBIS ACUTA, sp. nov.	74
	5. Small fragment of a frond	74
	5 ^a . Pinnule magnified	74
FIG. 6.	SPIENOLEPIDIUM VIRGINICUM, sp. nov.	259
	6. Fragments of two cones of <i>S. Virginicum</i>	259



PLATE CLXVII.

PLATE CLXVII.

	Page.
FIG. 1. TAXODIUM (GLYPTOSTROBUS) BROOKENSE, var. ANGUSTIFOLIUM, sp. nov.....	256
1. Portion of a large branch slightly restored.....	256
1 ^a . Part of an ultimate twig magnified.....	256
FIG. 2. SPHENOLEPIDIUM KURRIANUM, sp. nov.....	260
2. Fragments of a large branch.....	260
2 ^a . Portion of a primary twig magnified.....	260
2 ^b . Portion of a secondary twig magnified.....	260
2 ^c . Part of an ultimate twig magnified.....	260
FIG. 3. TAXODIUM (GLYPTOSTROBUS) BROOKENSE, sp. nov.....	254
3. Fragment of a large stem.....	254
FIG. 4. PHYLLOCLADOPSIS HETEROPHYLLA, sp. nov.....	204
4. Small fragment of a branch.....	204
FIG. 5. SEQUOIA REICHENBACHI, Heer.....	243
5. Leafy branch of the most common kind.....	243
FIG. 6. CARPOLITHUS BROOKENSIS, sp. nov.....	268
6. A nucleal body.....	268

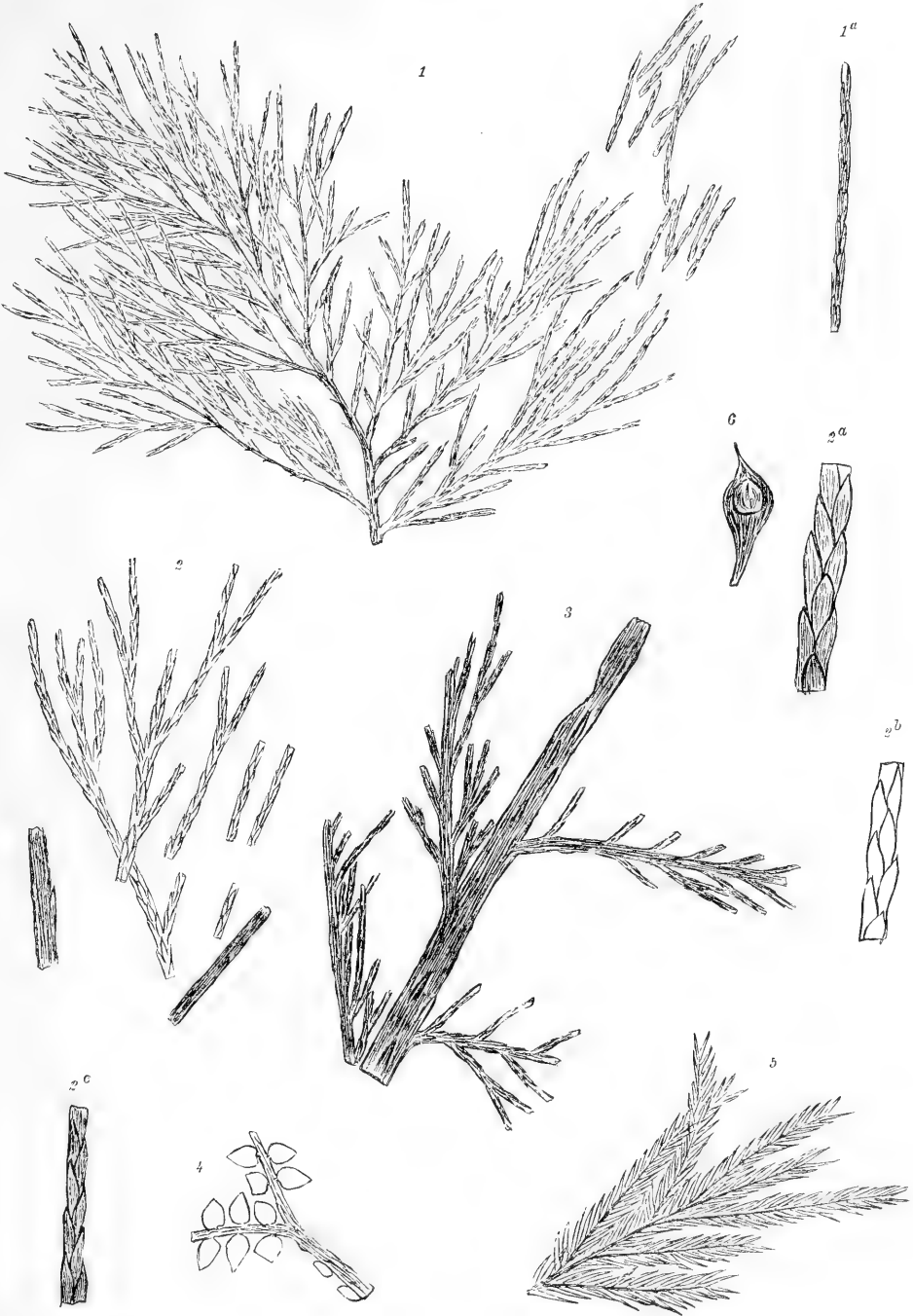

PLATE CLXVIII.

PLATE CLXVIII.

	Page.
FIG. 1. FRENELOPSIS PARCERAMOSA, sp. nov.	218
1. Portion of a branching twig with ultimate branches of the most common size	218
FIG. 2. BRACHYPHYLLUM, sp. ?	224
2. Undetermined cone, probably a fragment of a cone of Brachyphyllum	224
FIG. 3. DROONITES BUCHIANUS (Schimper), var. OBTUSIFOLIUS	184
3. Portion of a large leaf	184
FIG. 4. NAGEIOPSIS SUBFALCATA, sp. nov.	203
4. Small fragment of a branch	203
4 ^a . Leaflet magnified	203
FIGS. 5, 6. LARICOPSIS LONGIFOLIA, sp. nov.	233
5. Small fragments showing scars of fallen leaf-bundles	233
6. Fragment showing some leaf-bundles in place	233
FIG. 7. CARPOLITHUS VIRGINIENSIS, sp. nov.	266
7. Several nut-like seeds attached	266
7 ^a . Seed of 7 magnified	266
FIG. 8. ABETITES ELLIPTICUS, sp. nov.	263
8. Fragment of a cone	263
FIG. 9. BRACHYPHYLLUM CRASSICAULE, sp. nov.	221
9. Fragment of a much-branched twig	221

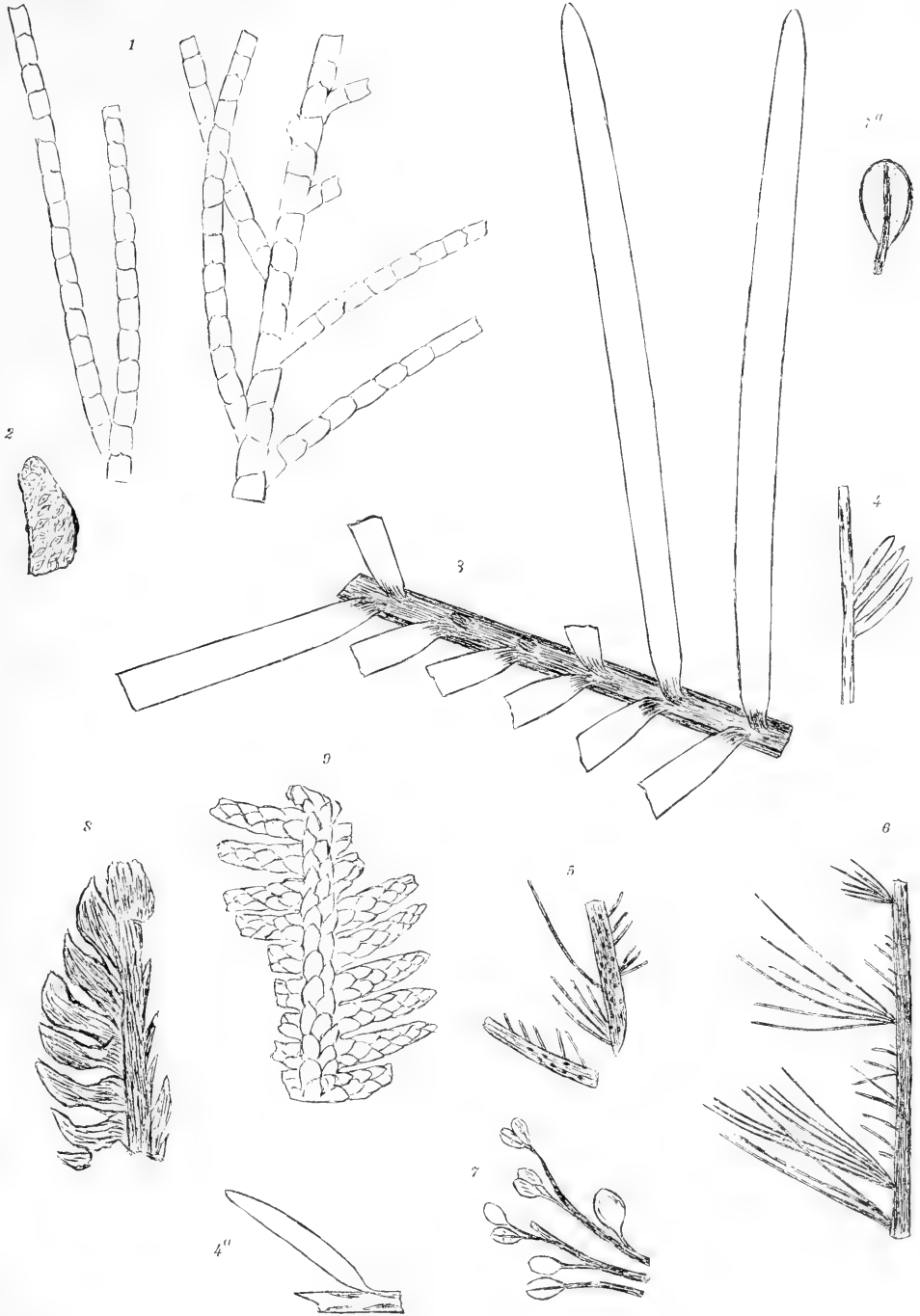

PLATE CLXIX.

PLATE CLXIX.

	Page.
FIG. 1. THINNFELDIA GRANULATA, sp. nov	111
1. Fragment of a frond	111
FIG. 2. CLADOPHLEBIS CONSTRICTA, sp. nov	68
2. Fragment of a small form	68
2 ^a . Portion of 2 magnified	68
FIG. 3. PECOPTERIS VIRGINIENSIS, sp. nov	82
3. Fragment from Covington street, Baltimore	82
FIGS. 4, 5. UNDETERMINED STEMS (g)	275
FIGS. 6, 7. THYRSOPTERIS RARINERVIS, sp. nov	123
6, 7. Fragments of large fronds	123
6 ^a . Pinna of 6 magnified	123
FIG. 8. CALLITRIS sp. ? sp. nov	272
8. What seems to be the cone of a Callitris	272
FIG. 9. UNDETERMINED STEMS (h)	276
FIG. 10. CELASTROPHYLLUM DENTICULATUM, sp. nov	306
10. Detached leaf	306
10 ^a . Portion of 10 magnified to show nervation	306

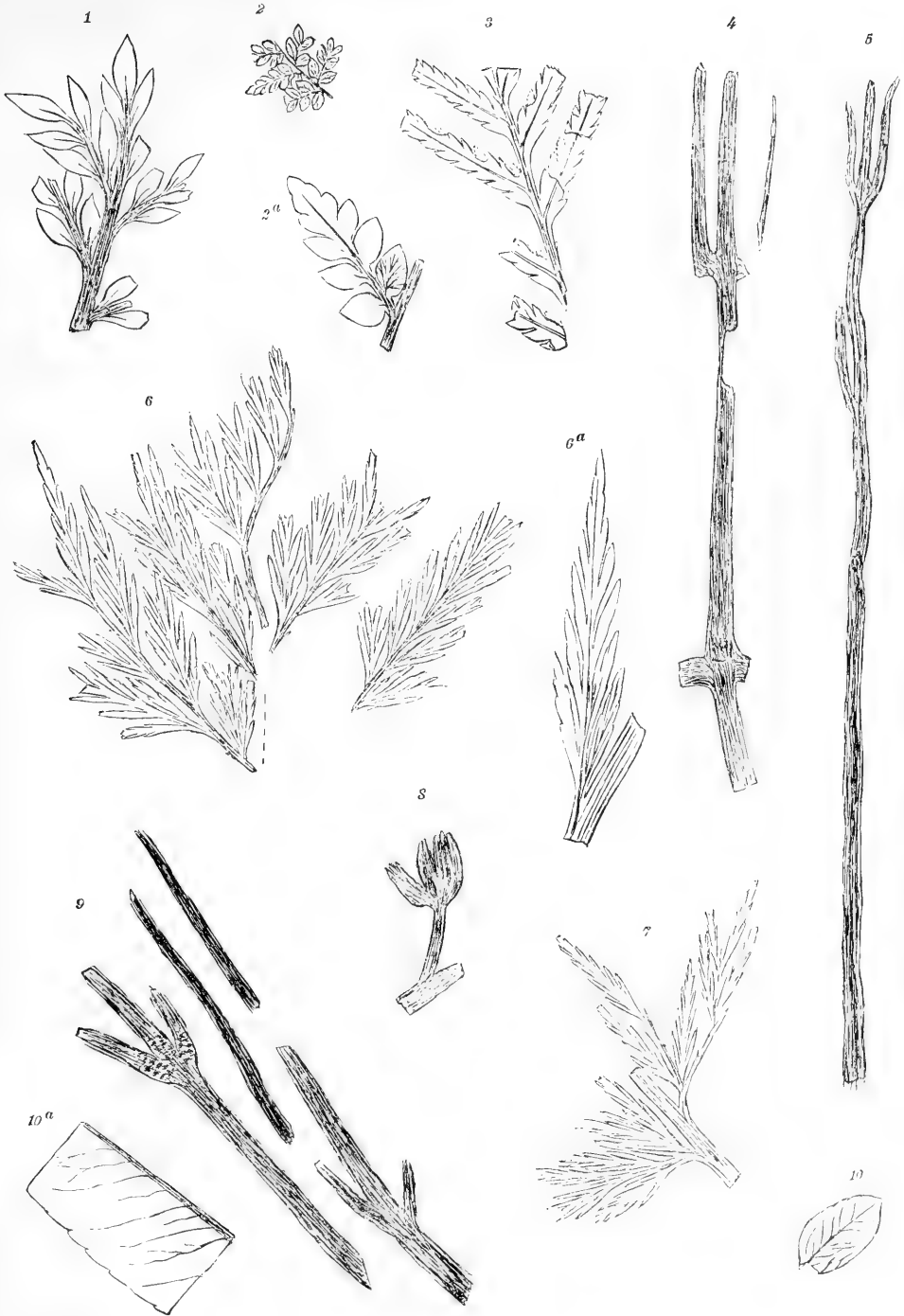

PLATE CLXX.

PLATE CLXX.

	Page.
FIG. 1. THYRSOPTERIS DIVARICATA, sp. nov	125
1. Small fragment of a frond	125
1 ^a . Portion of 1 magnified	125
FIG. 2. PODOZAMITES ACUTIFOLIUS, sp. nov	181
2. Fragment of a leaflet	181
FIG. 3. ZAMITES OVALIS, sp. nov	173
3. Tip of a leaflet	173
FIG. 4. PINUS, sp. ?	272
4. What seems to be the seed of a pine	272
FIGS. 5, 6. PECOPTERIS STRICTINERVIS, sp. nov	84
5. Fragment of a compound pinna	84
5 ^a . Pinnules of 5 magnified	84
6. Small fragment of an ultimate pinna	84
6 ^a . Pinnules of 6 magnified	84
FIG. 7. ACACLEPHYLLUM VARIABILE, sp. nov	281
7. Fragments of leafy twigs	281
FIG. 8. RHIZOME OF EQUISETUM, sp. ?	66
8. Rhizome, probably of <i>E. Marylandicum</i> , with tubercles	66
FIG. 9. PODOZAMITES SUBFALCATUS, sp. nov	179
9. Upper portion of a leaflet	179
FIG. 10. ACROSTICHOPTERIS LONGIPENNIS, sp. nov	107
10. Fragment of a frond	107
10 ^a , 10 ^b . Portions of 10 magnified, to show varying shape of fructification; 10 ^a is partly restored	107
FIG. 11. ACROSTICHOPTERIS DENSIFOLIA, sp. nov	107
11. Fragment of a frond	107

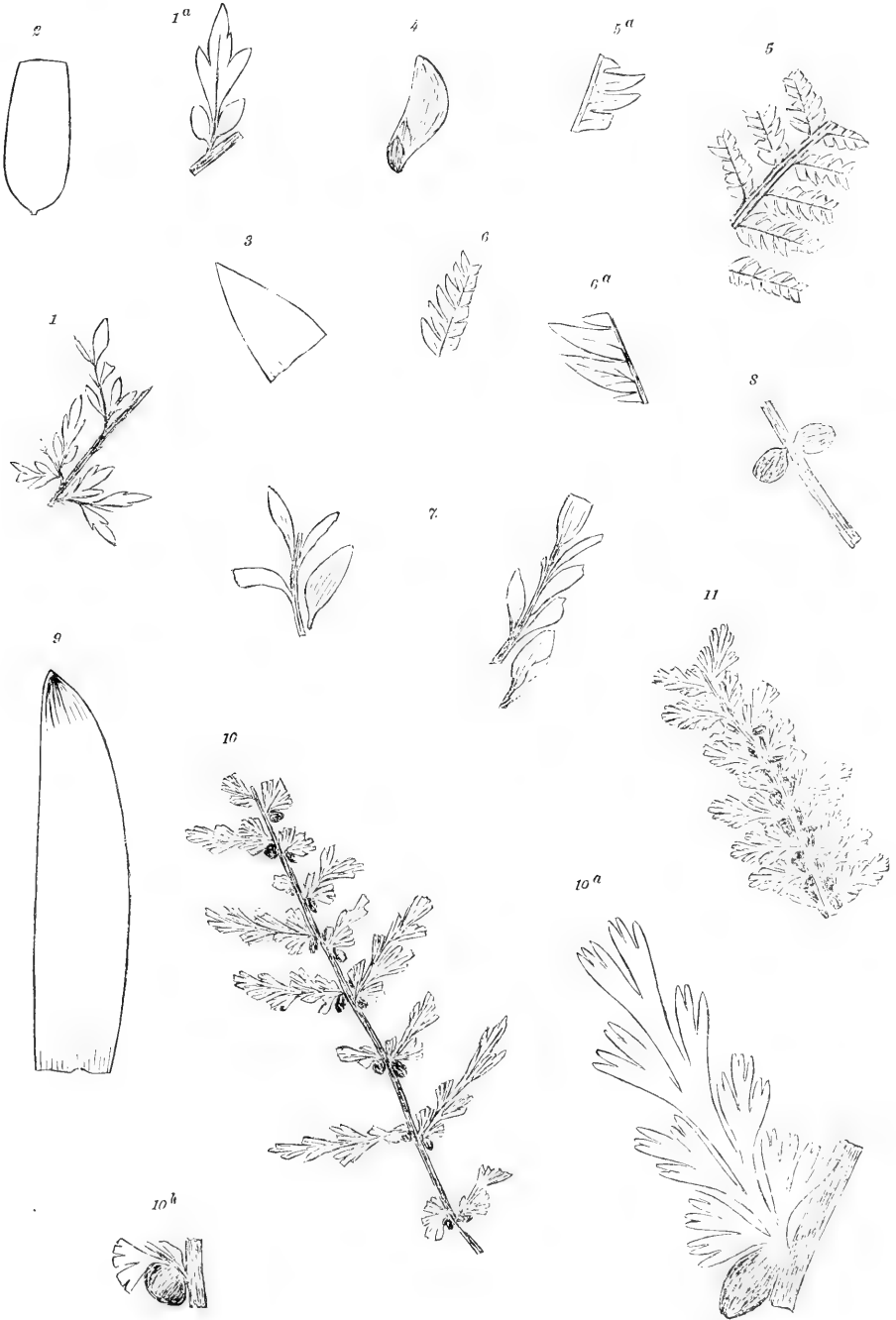

PLATE CLXXI.

PLATE CLXXI.

	Page.
FIGS. 1, 5, 7. ACROSTICHOPTERIS LONGIPENNIS, sp. nov	107
1. Fragment of a large frond.....	107
1 ^a . Portion of 1 magnified and partly restored.....	107
5. Portion of a frond retaining only the fructification.....	107
7. Fragment of a long compound pinna	107
7 ^a . Portion of 7 magnified and partly restored, showing the under side of the fructified pinnules	107
FIGS. 2, 6. ACROSTICHOPTERIS DENSIFOLIA, sp. nov.....	107
2. Fragment of a pinna	107
6. Small fragment of a pinna	107
6 ^a . Pinnule magnified and slightly restored.....	107
FIGS. 3, 4. ACROSTICHOPTERIS PARVIFOLIA, sp. nov	108
3. Small fragment showing two ultimate pinnae	108
3 ^a . Pinnule of 3 magnified.....	108
4. Small portion of a compound pinna, showing a very stout primary rachis.....	108
4 ^a . Ultimate pinna of 4 magnified and partly restored.....	108



PLATE CLXXII.

PLATE CLXXII.

	Page.
FIGS. 1, 4. <i>PROTEOPHYLLUM DENTATUM</i> , sp. nov.	286
1. Summit of a leaf	286
4. Fragment with margins of the leaf not preserved.....	286
FIG. 2. <i>CELASTROPHYLLUM TENUINERVE</i> , sp. nov.....	306
2. Basal portion of a leaf	306
FIGS. 3, 6. <i>CELASTROPHYLLUM LATIFOLIUM</i> , sp. nov.	306
3. Upper portion of a leaf	306
6. Entire leaf of small size	306
FIG. 5. <i>SALICIPHYLLUM PARVIFOLIUM</i> , sp. nov.	303
5. Entire leaf.....	303
FIG. 7. <i>CELASTROPHYLLUM DENTICULATUM</i> , sp. nov.	306
7. Portion of a leaf of the largest size	306
FIG. 8. <i>MENISPERMITES TENUINERVIS</i> , sp. nov.	322
8. Lower part of a thick leaf.....	322
FIGS. 9, 10. <i>CELASTROPHYLLUM OBOVATUM</i> , sp. nov.	307
9. Middle portion of a leaf	307
10. Fragment of the upper part of a leaf.....	307
10 ^a . Portion of 10 magnified three diameters	307
FIGS. 11, 12. <i>VITIPHYLLUM (CISSITES) PARVIFOLIUM</i> , sp. nov.....	309
11. Fragments of leafy branches	309
12. Fragment of a leafy branch.....	309
FIG. 13. <i>ACROSTICHOPTERIS DENSIFOLIA</i> , sp. nov.....	107
13. Fragment of a compound pinna.....	107
FIG. 14. <i>ACROSTICHOPTERIS PARVIFOLIA</i> , sp. nov.	108
14. Small fragment with a very stout primary rachis.....	108

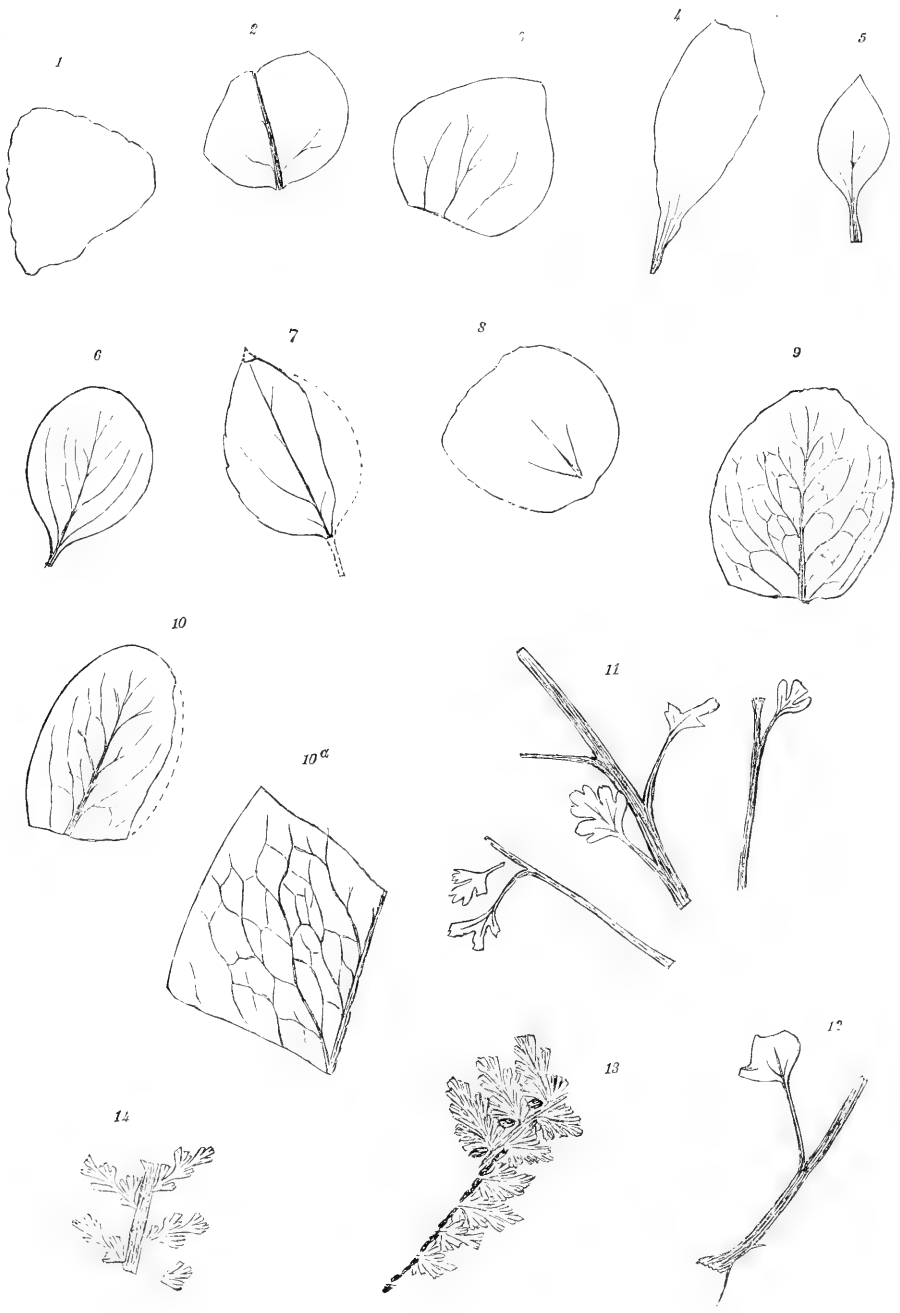



PLATE CLXXIII.

PLATE CLXXIII.

	Page.
FIGS. 1-9. VITIPHYLLUM (CISSITES) MULTIFIDUM, sp. nov	309
1-9. Portions of leaves varying in size and lobing	309
FIG. 10. FICOPHYLLUM CRASSINERVE, sp. nov	291
10. Fragment of a small leaf.....	291
FIG. 11. UNDETERMINED PLANT (i)	276
11. Possibly a sheath of Equisetum compressed vertically.....	276
11 ^a . The same magnified	276
FIGS. 12, 14. PROTEOPHYLLUM DENTATUM, sp. nov	286
12, 14. Fragments of the middle portions of leaves.....	286
FIG. 13. CELASTROPHYLLUM LATIFOLIUM, sp. nov	306
13. Fragment of the middle part of a leaf.....	306
13 ^a . Portion magnified to show nervation.....	306



1



2



3



4



5



6



10

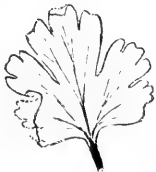

7



8



9

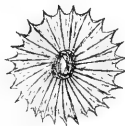

11^a



11

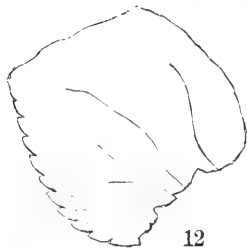

12



13

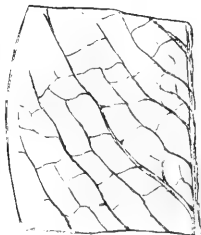

13^a



14



PLATE CLXXIV.

PLATE CLXXIV.

	Page.
TYSONIA MARYLANDICA, sp. nov. (half natural size)	193
View of the better broad side of trunk No. 1, the smaller one	193



PLATE CLXXV.

PLATE CLXXV.

	Page.
TYSONIA MARYLANDICA, sp. nov. (half natural size)	193
View of the better narrow side of trunk No. 1.....	193

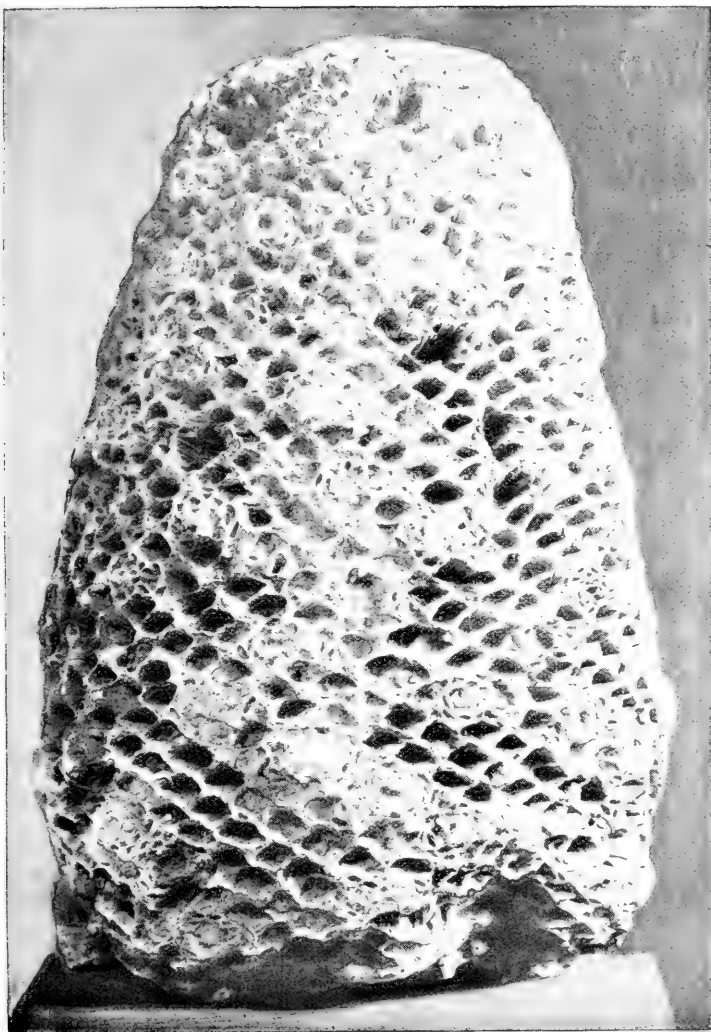

PLATE CLXXVI.

PLATE CLXXVI.

	Page.
TYSONIA MARYLANDICA, sp. nov. (half natural size)	193
View of the imperfect broad side of trunk No. 1	193



PLATE CLXXVII.

PLATE CLXXVII.

	Page.
TYSONIA MARYLANDICA, sp. nov. (half natural size).....	193
View of the base of trunk No. 1	193



PLATE CLXXVIII.

PLATE CLXXVIII.

TYSONIA MARYLANDICA, sp. nov. (half natural size).....	Page. 193
View of top of trunk No. 1.....	193

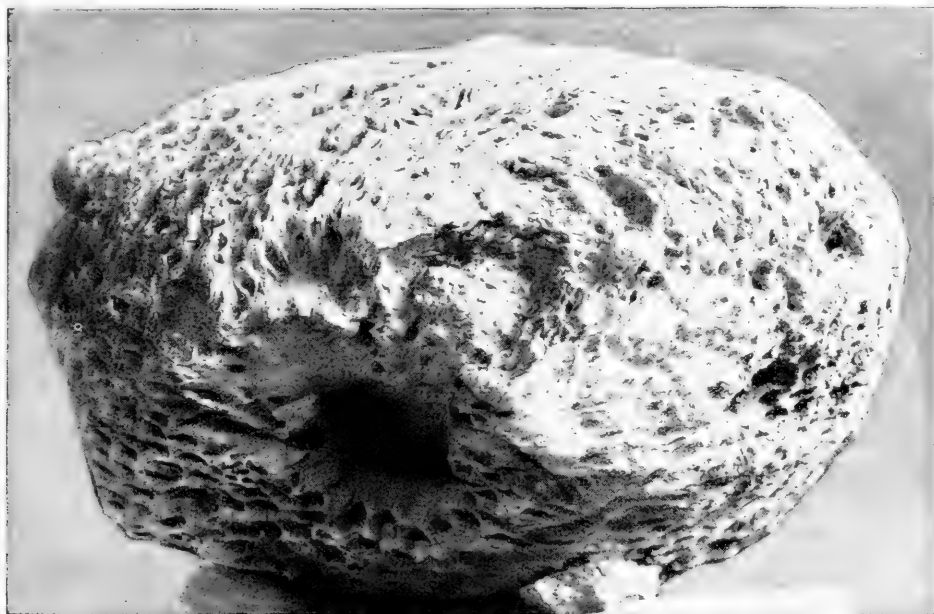

PLATE CLXXIX.

PLATE CLXXIX.

	Page.
TYSONIA MARYLANDICA, sp. nov. (half natural size).....	193
View of the broad side of trunk No. 2.....	193

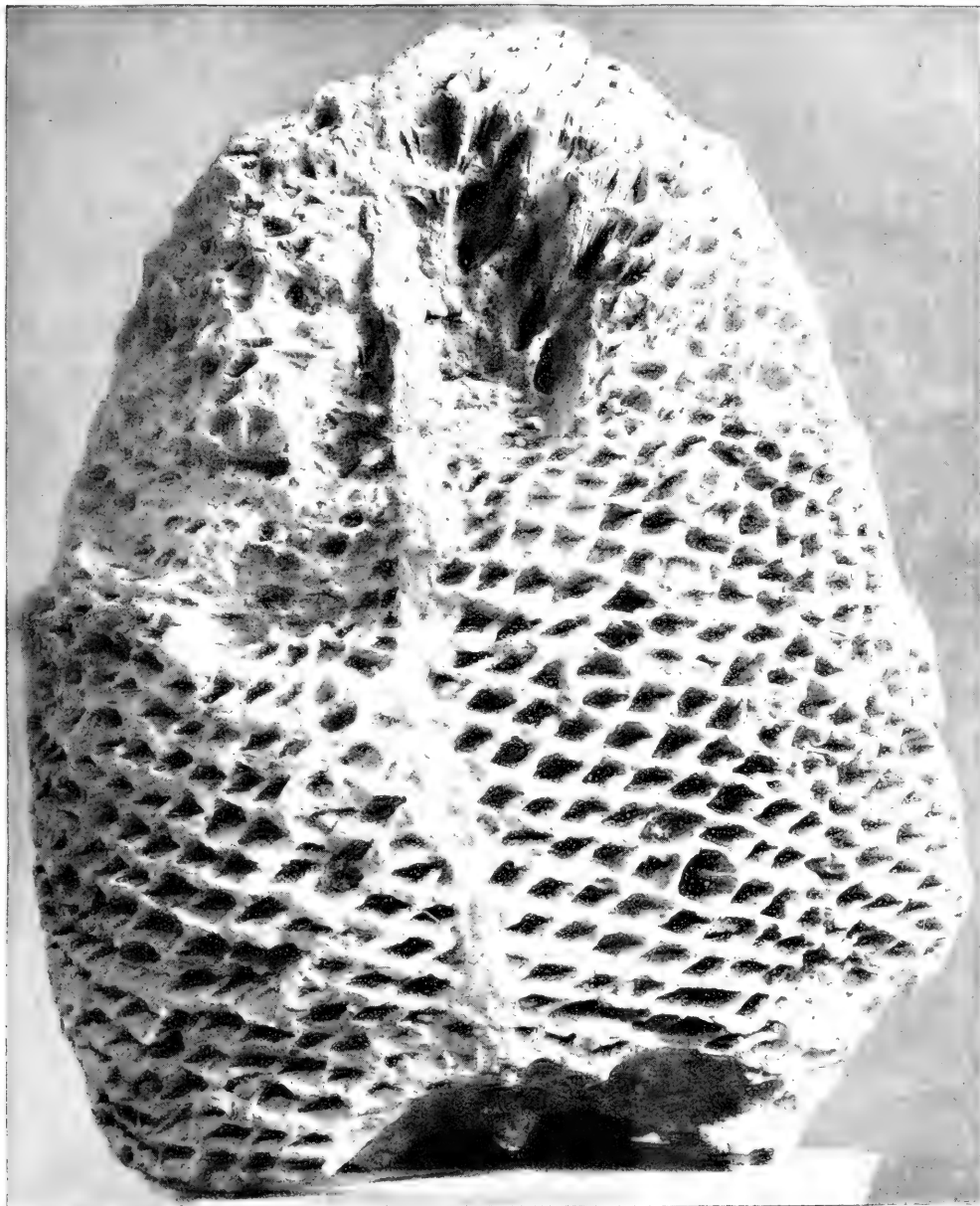

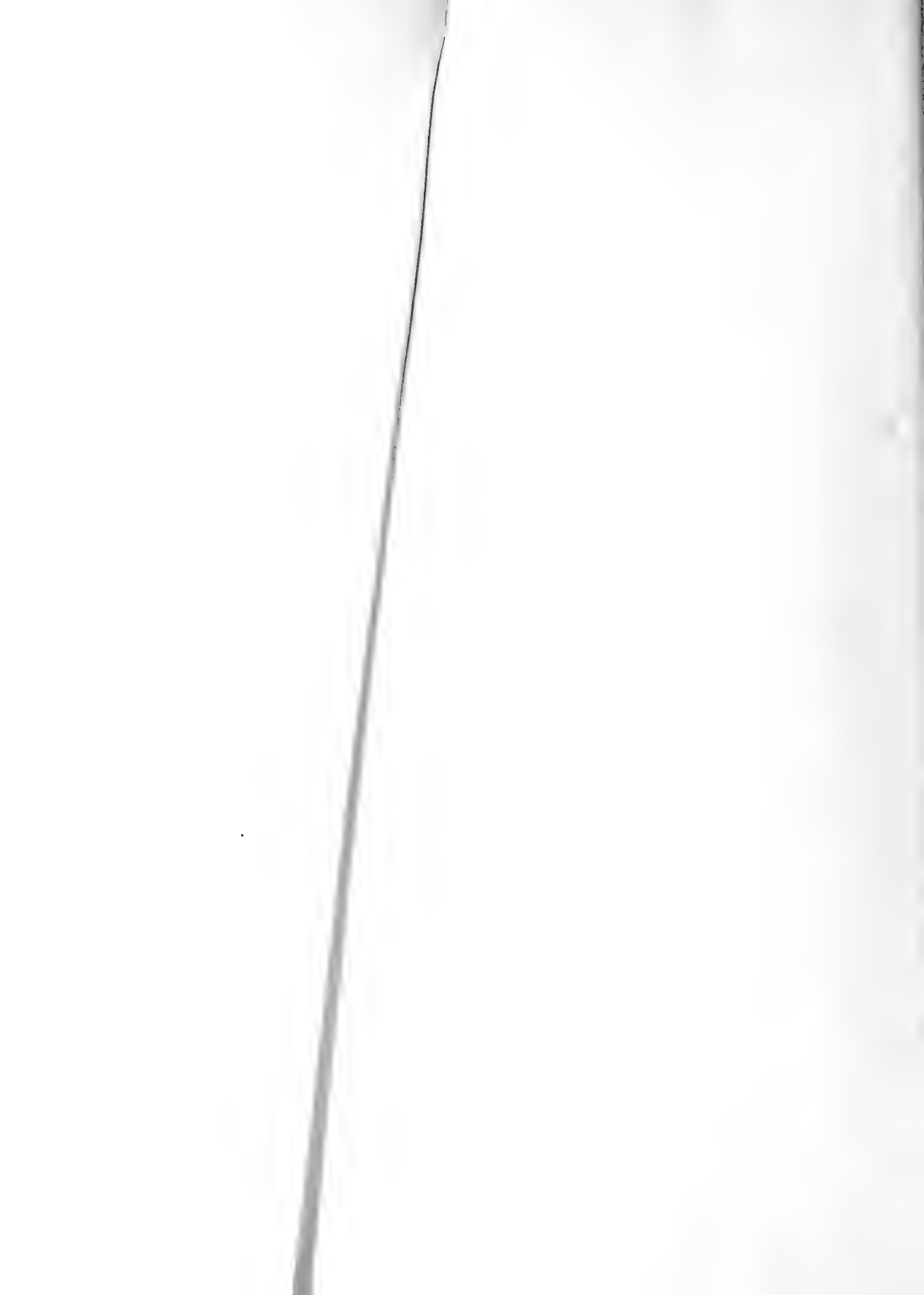

PLATE CLXXX.

PLATE CLXXX.

	Page.
TYSONIA MARYLANDICA, sp. nov. (half natural size).....	193
View of the narrow side of trunk No. 2.....	193





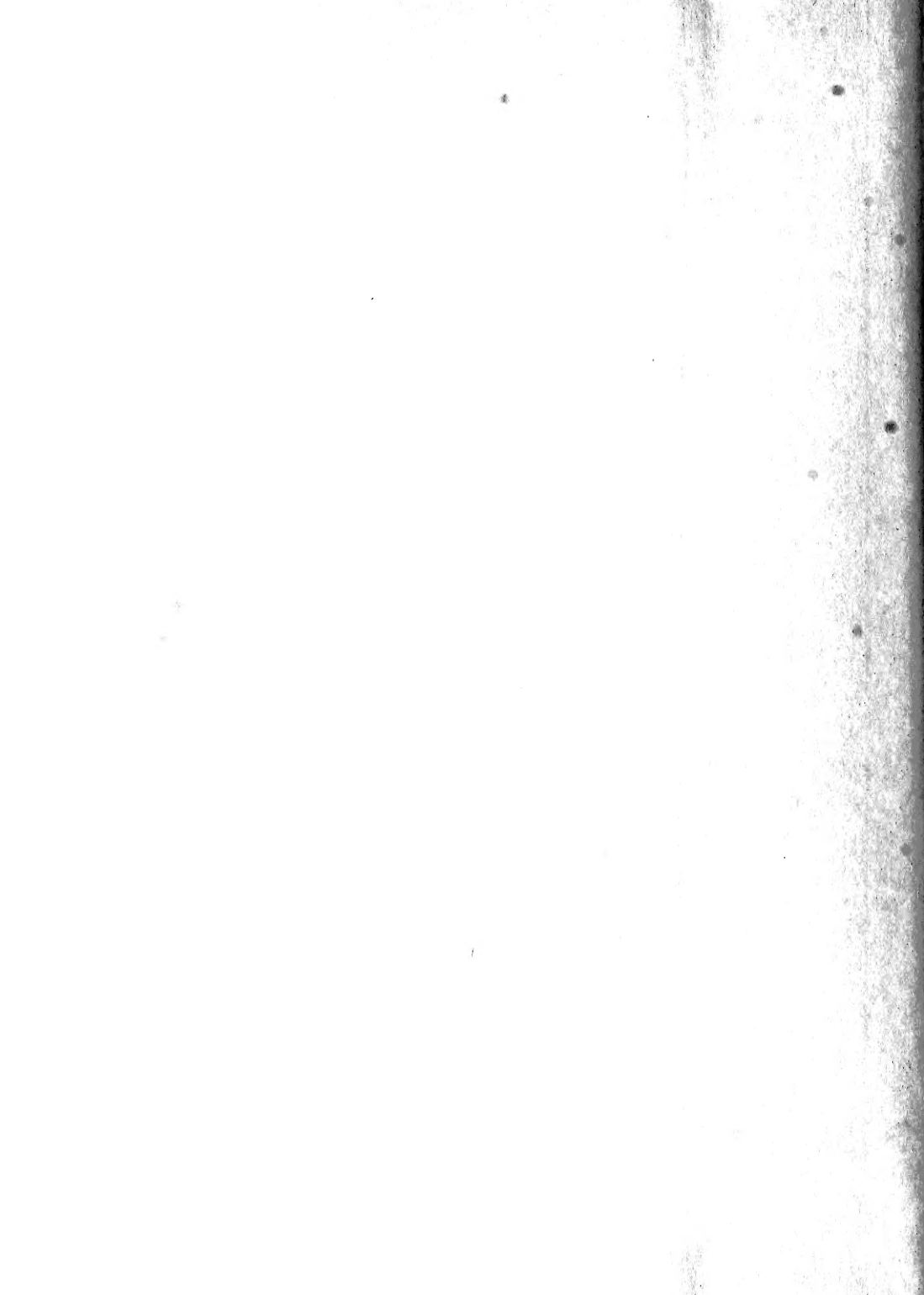

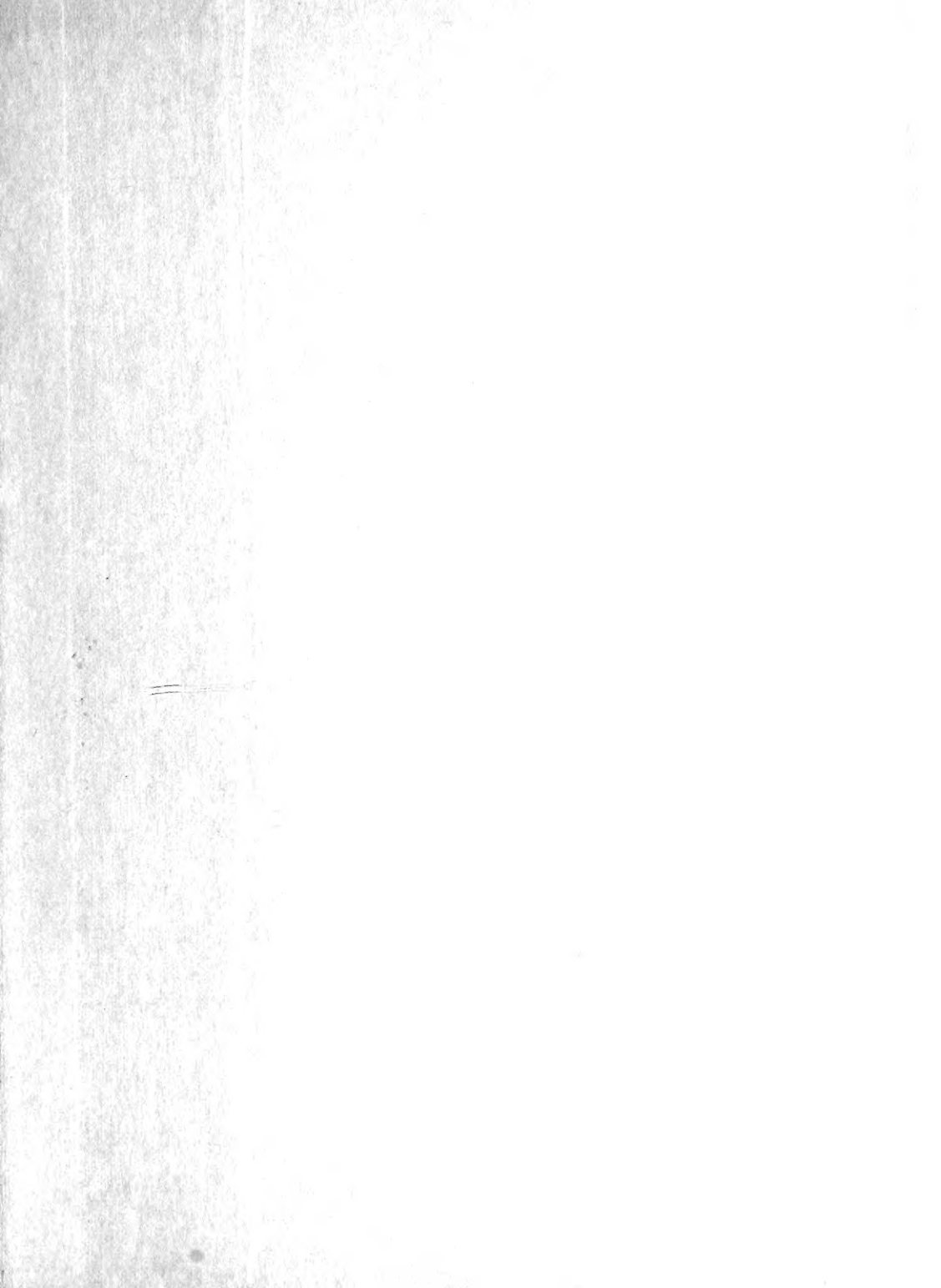

SMITHSONIAN INSTITUTION LIBRARIES



3 9088 01363 2245